



Commercial  
Vehicles

# The Caddy Brochure

# 100% new. And still 100% Caddy.

## The multifunctional everyday companion

### More innovative, dynamic and efficient than ever before

The Caddy from Volkswagen Commercial Vehicles, will be coming into its fifth generation in Spring 2020, on a completely new evolutionary level.

You always have the future in mind. The new Caddy also follows this claim. With a new, exciting design, the most modern driver assistance systems, innovative infotainment and an ergonomic driver's workstation, the new Caddy is reliable, flexible and progressive as usual. So the perfect partner when it comes to managing your day-to-day comfortably.

### Comprehensive redesign:

- Completely newly developed vehicle at car level basis of the successful Volkswagen modular transverse matrix (MQB) for the implementation of new high-end technologies
- New standards in efficiency and sustainability through innovative drive technologies
- Innovative exterior and interior design based on the latest aerodynamic and ergonomic criteria
- Many of the most modern, competitive driver assistance systems and Infotainment systems and operating functions
- 100% networked and digital

### Innovative driver assistance systems

The superior development competence of Volkswagen Commercial vehicles also shows itself in the field of future-oriented Driver assistance in the form of partially automated driving functions. Of the 19 driver assistance systems now available, including many optimized, five systems are completely new (depending on the model as standard or optional individually or in Package available):

- Trailer shunting assistant "Trailer Assist"
- Parking assistant
- Emergency Assist (only in conjunction with DSG)
- Driver assistant "Travel Assist"
- Lane change assistant "Side Assist"



### State of the art digitization and connectivity

The new Caddy offers the option on request to set up a digital high-tech cockpit with outstanding functionality and unique ease of use.

### The central elements of the new digital Caddy world:

- Digital cockpit
- Touch color displays up to 25.4 cm (10 ") screen diagonal
- Innovision Cockpit (Digital Cockpit in conjunction with 10 "touch color display)
- Digital touch surfaces for light, visual, audio and menu functions
- "Comfort" telephone interface with inductive charging function
- Online Connectivity Unit (OCU) with integrated SIM card (eSIM)
- The latest generation of mobile online services (MOD 3.2)

# Innovative Cockpit

## Pioneer in the segment

### Interactive interfaces in a modern car environment

The completely redesigned cockpit sets new standards in optics, Ergonomics and functionality. The new cockpit is impressive with intuitive operation via digital control surfaces, fast menu navigation via direct entry buttons, high-quality seating comfort and particularly hard-wearing materials.

### *The main features of the new cockpit:*

- Newly designed instrument panel with diverse, different shaped storage space for driver and front passenger over the entire width above.
- New center console with 2 USB interfaces (type C) at the front
- Digital cockpit, multicolored, various info profiles can be selected (optional)
- Infotainment systems of the latest MIB generation with 16.51 cm (6.5 ") to 25.4 cm (10") color touch displays (optional)
- InnoVision Cockpit (Digital Cockpit in conjunction with 10 "touch color display)(optional)
- Digital touch surfaces for light, visual, audio and menu functions
- LED reading lights, dimmable and with touch operation
- New MQB multifunction steering wheel in leather with capacitive contact detection (standard with dual clutch transmission DSG as well as optional)
- New seat upholstery designs (optional)
- Back panel on the back of the front passenger seat (optional)



# Modernized headlight and tail light concept

## Enlightening technology

*More light, more visibility, more security.*

The new generation of models offers significantly improved lighting and visibility. Depending on the model, H7 halogen double headlights or LED main headlights with LED daytime running lights installed. At the same time, LED headlights form the requirement for the new bad weather light option and cornering lights (LED technology). Also new are the taillights in LED technology (optional).

### H7 halogen double headlights:

- Improved light output thanks to a significantly larger light cone



### LED main headlights with LED daytime running lights:

- Significantly better visibility thanks to around 30% higher luminous flux, wider light distribution and greater range
- Lower wear costs and downtimes thanks to long-life and energy-saving LEDs
- Electronic headlight range adjustment for automatic Adaptation to all load conditions



### LED main headlights with LED daytime running lights, with bad weather lights and cornering light (LED technology):

- Additionally, improved illumination of the road poor visibility, manual activation when switched on ignition
- Automatic switching on of the cornering light for better Illumination of the roadway and the surrounding area at turning or in tight bends



### LED taillights:

- SBBR luminaires in LED technology instead of conventional lightbulbs
- Significantly reduced power consumption and therefore lower fuel consumption
- Much longer service life
- Faster response behavior (0.2 sec.)

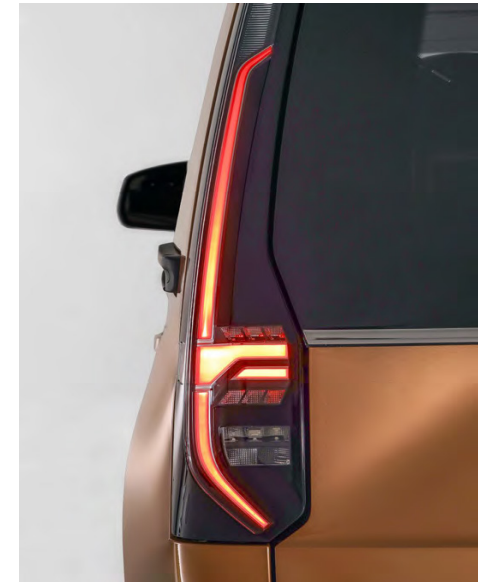

# Outstanding assistance functions

## More driving comfort and safety with intelligence

### Veritable customer benefits

Volkswagen Commercial Vehicles offers a superior variety of innovative driver assistance systems. To the existing Systems such as multi-collision brake (standard), automatic ACC distance control, park steering assistant "Park Assist", lane departure warning system "Lane Assist" and "Front Assist", various new driver assistance systems are now available in the new generation Caddy.

### NEW: Emergency Assist (optional)

Emergency Assist can detect when the driver is inactive and keep the vehicle in the lane, the hazard warning lights switch on and, if necessary, brake the vehicle to a standstill. Before that, the driver is first optically and acoustically, then warned by brake jolts. A steering intervention or an actuation of the accelerator pedal the driver can change the braking strategy at any time abort.

The activation takes place via direct input key and tile in the display of the infotainment system. Requirement for the Function are activated driver assistant "Travel Assist" and Lane Assist (available in combination with dual clutch gearbox DSG).

### The customer benefits:

- Active contribution to the prevention of an accident or to mitigation of possible consequences of an accident
- Triple warning to the driver if inactivity is detected
- Automatic, safe braking of the vehicle during z. B. health impairment of the driver
- Warning other road users when inactive driver

### NEW: "Travel Assist" driver assistant with Emergency Assist (optional)

The driver assistant "Travel Assist" with Emergency Assist eases driving the vehicle on the motorway and others well-developed roads. It uses the same sensors as that automatic distance control ACC and the lane departure warning system "Lane Assist", expanded to include adaptive lane guidance. A combined longitudinal (speed / distance control) and lateral guidance (tracking) can be the vehicle a distance selected by the driver from a vehicle in front stop the vehicle and stay in the preferred position stay within the lane.

Switching on and off takes place via the steering wheel button, the configuration via direct input key and touch color display. The activated function is shown in the multifunction display.

### The customer benefits:

- Relaxed driving
- Increased safety, especially on long journeys

Emergency Assist (schematic diagram).

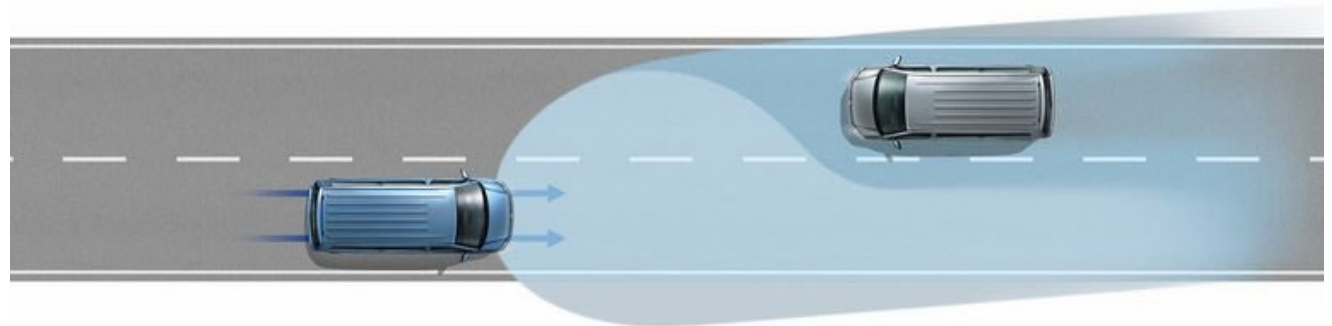
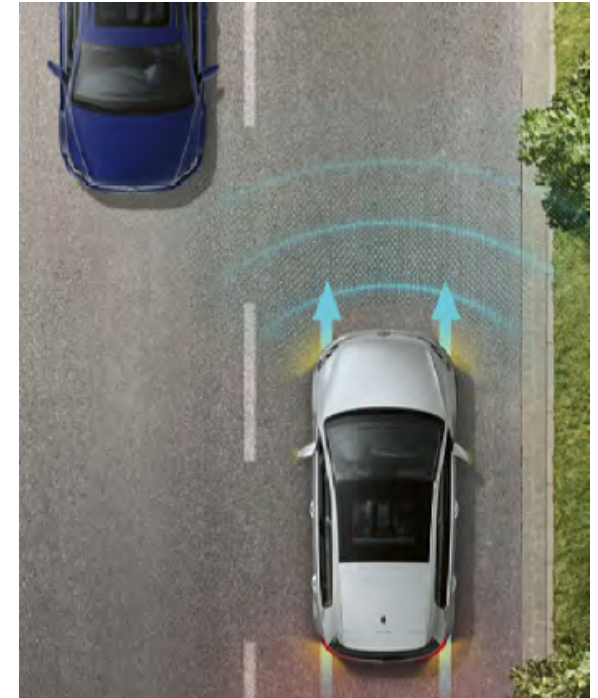

### **NEW: "Side Assist" lane change assistant (optional)**

The lane change assistant "Side Assist" (two radar sensors in Rear bumper left and right) gives the driver a visual warning a vehicle in the blind spot or in the approach zone. The warning is given by a constant lighting of the LED warning light on the respective exterior mirror housing. If the driver still turns on the indicator, the respective LED light begins flashing with increased brightness to indicate the potential risk of collision to draw attention.

The customer benefits:

- Support for the driver in recording the traffic situation behind the vehicle when overtaking or when changing lanes
- Ideal technical addition to the vehicle (exterior mirror) and for the driver (look over the shoulder) to prevent dangerous situations when changing lanes
- Reduced accident risk due to careless lane changes

### **Road lane change assistant "Side Assist"**



### **Emergency braking assistant "Front Assist" with new additional functions (optional)**

The "Front Assist" emergency braking system can be operated using a multifunction camera in the upper area of the windscreen and radar sensor recognize imminent frontal collisions in the front of the vehicle and warn against them. Furthermore, the system should support the driver in braking and swerving in the event of danger or, if the driver fails to react, the vehicle will brake automatically.



### **NEW: Parking assistant (optional)**

The parking assistant monitors the side area behind the vehicle using two radar sensors in the rear bumper catcher left and right. He warns when reversing out of parking spaces acoustically before an impending collision with cross traffic. Responds If the driver does not, emergency braking takes place automatically.

Activation and display depend on the respective level of equipment of the vehicle.

The customer benefits:

- Makes it easier to reverse out of parking spaces, e.g. B. narrow construction site or exits to the yard
- Preventing possible accidents or reducing possible accidents consequences of the accident
- Increasing the safety of all road users



### **New additional functions:**

- Pedestrian and cyclist detection to avoid accidents with personal injury when crossing and lengthways moving pedestrians or cyclists (active from 5 to 85 km / h)
- Evasion support when recognizing static obstacles and an evasive maneuver initiated by the driver through corrective steering intervention
- Turning assistant with automatic braking function and simultaneous warning to prevent a collision with an on coming vehicle when turning

### **Important NOTE**

In principle, the following applies to all driver assistance systems, they can only work within their respective system boundaries. They are designed to detect and avoid accident risks by being in critical driving situations warnings, supports and to relieve the driver, but do not replace. The driver stays at all times legally responsible for the behaviour of his vehicle in traffic.

# Connected infotainment

## Well networked

### Seamless connectivity prepared as standard

Connectivity to the Internet and thus diverse functions, which are known to the customer from the smartphone world, characterize the new infotainment system of the third Generation of the modular infotainment kit (MIB3) and the Mobile Online Services (MOD 3.2) from Volkswagen Commercial vehicles.

Thanks to the new integrated SIM card (eSIM = embedded SIM) becomes the coupling with the smartphone or the use of other Interfaces superfluous. The eSIM card enables the direct use of online-based functions and services such as B. Media streaming and natural language Infotainment operation.

The eSIM card is placed in the OCU (Online Connectivity Unit), so in the access unit to the Internet for vehicle-specific Services that are an integral element of the new wiring system architecture forms. This way the vehicle is on Request online right from the start and can also be upgraded - can use various vehicle functions and services can be subsequently activated.

### Radio "Composition" (Standard)

Device structure and functions:

- 20.96 cm (8.25 ") color touch display
- 2 USB interfaces (type C) in the center console, front
- Bluetooth® hands-free function
- Prepared for "We Connect" and "We Connect Plus" (1 year)

Also optionally available:

- Digital radio reception (DAB +)
- "Comfort" mobile telephone interface with inductive charging function
- 2 USB charging sockets (type C) on the rear center armrest (at Caddy)
- Wired App-Connect
- We Connect Fleet (1 year)



### Radio "Ready 2 Discover " (Optional)

Device structure and functions in addition to radio "Composition ":

- 25.4 cm (10 ") color touch display incl. " Streaming & Internet "
- Digital radio reception (DAB +)
- Smartphone integration
- Media storage basic (32 GB) and media control

Also optionally available:

- "Comfort" mobile telephone interface with inductive charging function
- Voice control
- Wireless App-Connect
- Additional functions (e.g. navigation)



### **“Discover Media” navigation system (not illustrated)(Optional)**

Device structure and functions in addition to radio “Ready 2 Discover “:

- Hybrid navigation function
- Prepared for “We Connect” and “We Connect Plus” (1 year)

Also optionally available:

- “Comfort” mobile telephone interface with inductive charging function
- Voice control
- Wireless App-Connect

### **“Discover Pro” navigation system (not illustrated) (Optional)**

Device structure and functions in addition to the navigation system “Discover Media”:

- “Comfort” mobile telephone interface with inductive charging function
- Voice control
- Wireless App-Connect
- Large media memory (64 GB)
- Prepared for “We Connect” and “We Connect Plus” (3 years)



### **Wired & Wireless App-Connect**

App-Connect from Volkswagen Commercial Vehicles enables safe and convenient use of selected smartphone Apps via the infotainment system and is now also available in the new Caddy. App-Connect is available for radio “Composition” with connection via USB interface (wired) and for radio “Ready 2 Discover “and the two navigation systems “Discover Media “and” Discover Pro “each with wireless connection (wireless).

The apps and their content are shown on the touch display of the Infotainment system and can be viewed from there can be operated conveniently and clearly. So it can be straightforward on z. B. Music, news, maps or audio books to fall back on.

App-Connect includes the technologies MirrorLink®, Apple CarPlay™ and Android Auto™.

### **Hybrid navigation function**

Hybrid navigation means the simultaneous use of several Navigation systems, d. H. satellite and online based. This is intended to ensure comprehensive, seamless availability location data for navigation can be guaranteed. In the In practice, the accuracy of the position is increased and the susceptibility to errors (e.g. by external influences).



# Volkswagen We Connect

The latest generation of digital services



## We Connect



We Connect provides vehicle-related online Services from Volkswagen Commercial Vehicles. The services are available from radio "Composition"<sup>1) 2)</sup>

The "We Connect" package is the entry point into digital Services from Volkswagen Commercial Vehicles and equips the vehicle with integrated connectivity. We Connect offers one-time activation as a license package numerous helpful basic functions online with no runtime restrictions.

The customer benefits:

- Faster help in the event of a breakdown
- Simple retrieval of driving data, vehicle status and vehicle condition via smartphone
- Easy to find the parked car again

## We Connect Plus



We Connect Plus offers add-on license packages additional smart functions of intelligent navigation with Real-time information via media streaming and web radio to using the smartphone as a remote control for practical vehicle functions (duration 1 to 3 years). Available from the "Discover Media" navigation system.

The customer benefits:

- Optimal, situational route guidance natural voice control
- Remote control of functions such as auxiliary heating or vehicle locking
- Easier to find a parking space

## We Connect Fleet



With the "We Connect Fleet" add-on business package Volkswagen Commercial Vehicles commercial customers a simple solution to make small and medium-sized fleets efficient manage. We Connect Fleet allows via the web portal quick and uncomplicated access to the most important vehicle and fleet information. Characteristic Services are u. a. digital logbook, digital fuel log, consumption analysis and maintenance management. Available from Radio "Composition".

The customer benefits:

- Improved predictability
- Shorter downtimes
- Comprehensive cost control
- Relief for fleet managers and drivers

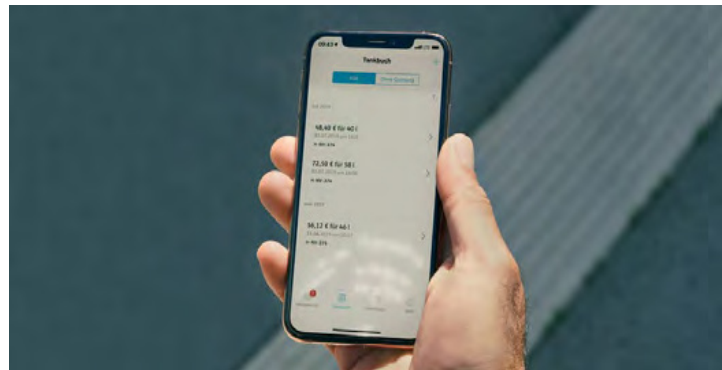

1) To use the We Connect services, the customer needs a Volkswagen ID user account and must log in to We Connect with a username and password. Furthermore, a separate We Connect or Conclude a We Connect Plus contract with Volkswagen AG online. 2) Depending on the time of use.

# New equipment details

## Particularly ergonomic

### Touch control module for light and visibility.

The conventional rotary switch for the light was used by all models through a specially designed new touch control module to the right of the steering wheel. The module represents a characteristic element of the new design and functionality concept of the fifth model generation.

The functions:

- Operation via capacitive keypads
- Low beam / parking light
- Fog lights / bad weather light
- Rear fog light
- Heated windscreen / heated rear window
- Control light mode

The customer benefits:

- Central control of the light and visual functions
- Better clarity and improved user ergonomics
- Tidy interior
- Modern design



### Direct entry key module

Via direct entry buttons in the center below the infotainment display (from radio "Composition") arranged operating modules functions are called up in the control panel of the display.

The operating module has the following direct access keys occupied:

- Driver assistance systems (ASSIST)
- Air conditioning, heating and fresh air system (CLIMA)
- Assistance systems for parking and maneuvering (MENU)

The customer benefits:

- Central and clear operation of all relevant functions



### Electronic parking brake with auto-hold function

The electronic parking brake replaces the conventional handbrake via a button in the center console. Indicator lights in the button and in the instrument cluster show whether the parking brake is activated. Likewise, a working noise conveys that the brake is closed.

The integrated auto-hold function secures a separate Button the vehicle to prevent it from rolling away when stationary, without the vehicle must be stopped with the foot brake. If the vehicle starts or the requirements for the car Hold function are not fulfilled, the hold is terminated.

The customer benefits:

- Simple operation via one button
- Additional security through the auto hold function
- More storage space between the front seats by eliminating them of the handbrake lever



# New paintwork and wheels

## The exterior paintwork

### Non-metallic



Candy White

### Metallic



NEW: Copper Bronze Metallic



Indium Grey

### Pearl Effect



Deep Black Pearl



Cherry Red



NEW: Costa Azul Metallic



Mojave Beige Metallic



NEW: Golden Green Metallic



Reflex Silver Metallic



Fortana Red Metallic



Starlight Blue Metallic

## Completely new range of wheels

### 17" Wheels (tires 215/55 R 17)



Full wheel cover for steel wheel  
6.5 J x 17  
(standard Caddy)



"Colombo" alloy wheel 6.5 J x  
17, high-sheen in dark graphite



"Colombo" alloy wheel 6.5 J x  
17, in Giallo Evros gloss black



"Barahona" alloy wheel 6.5 J x  
17, in brilliant silver  
(standard Life)

Completely new range of interior trims



"Double Grid" fabric



"Trialog" fabric



"Pure Diamond" leatherette

Choose your trimline.

# Caddy equipment.

## Exterior

- Exterior mirrors, power-adjustable and heated
- Black painted exterior mirror housings, body-colored door handles and Silver sliding door rail
- Preparation for roof rails/roof rack
- Tailgate with window aperture
- Rear window wiper and washer system with intermittent control (heated)
- H7 twin halogen headlamps
- 4 steel wheels 6.5J x 17, Silver (incl wheel trims)
- Tires 215/55 R17 98H XL low rolling resistance
- Rear combination lamps
- Bumpers painted in body color
- Dual sliding doors

## Interior

- Overhead storage compartment in cab (tray in headliner with 2 roof grab handles in cab)
- Carpet floor covering
- Matte cockpit bezel
- Matte Black vents in front
- Acoustics package Standard for cab
- Luggage compartment cover, folding and removable
- Illuminated glove compartment with lid
- 3 seater bench in 2nd row of seats (fold., fold./tipp., remov.)
- 2 single seats in 3rd row
- Electronically controlled heating system
- Side windows (fixed) in passenger compartment
- LED reading light in passenger compartment
- Dimming breakaway interior rearview mirror
- Lumbar support manually adjustable, left and right
- Leather-wrapped multi-function steering wheel
- Center console with 2 universal beverage holders
- Non-smoker's package
- Gearshift lever in leather
- Heat-insulating glass (green)
- Seat trim covers in fabric "Double Grid"
- Height adjustment for both front seats, manual
- Comfort side trim panel in passenger compartment
- Sun visors with mirror, airbag label on front passenger sun visor
- Door trim panel in plastic with armrest in fabric
- Heat-insulating windshield made of laminated glass

## Safety

- Driver and front passenger airbags with front passenger airbag deactivation
- Immobilizer (electronic)
- Electrical child safety lock for the sliding doors
- Servotronic (speed-sensitive power steering)
- Headlight range control
- Multi-function display Plus
- Tire Pressure Monitoring System (EU)
- Tire Mobility Set
- 3-point seat belts in front with seat belt height adjustment and electric seat belt pretensioners
- Side and curtain airbag for driver and front pass., curtain airbag for outer seats in rear
- Warning signal and warning light for seat belts
- Seat belts in passenger compartment with seat belt pretensioners
- 2 remote control folding keys
- Start-stop system with regenerative braking
- Central locking system with radio remote control
- First aid kit, warning triangle and 1 safety vest
- Child seat anchors (i-Size)

## Assistance Systems

- Swerve support and oncoming vehicle braking when turning
- Auto. Emergency Braking Front Assist with Pedestrian and Cyclist Monitoring
- Park Distance Control in rear
- Automatic headlight control with separate daytime running light
- Cruise control system incl. speed limiter
- Driver alert system
- eCall Emergency System
- Lane keeping system Lane Assist

## Audio & Communication

- App-Connect
- Radio "Composition" with 20.96-cm (8.25-inch) color touch screen
- Mobile phone interface
- 2 USB interfaces (type C) in the center console
- Digital radio reception (DAB+)

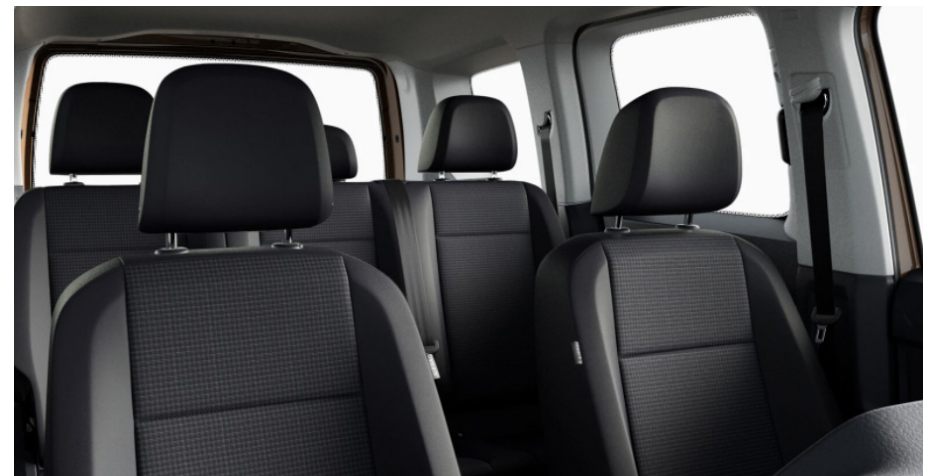

Choose your trimline.

## Life equipment.

### Exterior

- Exterior mirrors, power-adjustable, heated and power-folding
- Black roof rails
- Windshield wiper intermittent control with light and rain sensor
- 4 alloy wheels "Barahona" 6.5J x 17, Brilliant Silver

### Interior

- Removable waste bin with cover, for cab
- Vents in front with chrome bezels
- Acoustics package Extra for cab and passenger compartment
- Air conditioning system
- Folding table on the back of the seats in the 1st row of seats
- Backrest release for left front seat
- Front center armrest, height- and longitudinally adjustable w/ 2 beverage holders in front and 2 vents in rear
- Drawers under front seats
- Seat trims in fabric "Trialog"

### Assistance Systems

- Park Distance Control in front and rear
- Automatic headlight control with separate daytime running light and entry and exit lighting



# New technical information

## Dimensions

Dimensions	Caddy 5 Maxi Panel Van
Length (mm)	4,853
Width (mm)	2,100
Height (mm)	1,818
Wheelbase (mm)	2,970
Towing Capacity (kg)	1,500
Roof Load (kg)	100
Load compartment length (mm)	2,150
Load compartment width (mm)	1,613
width between wheel arches (mm)	1,230
Max. height of load compartment (mm)	1,274
Sliding door width (mm)	845
Sliding door height (mm)	1,095

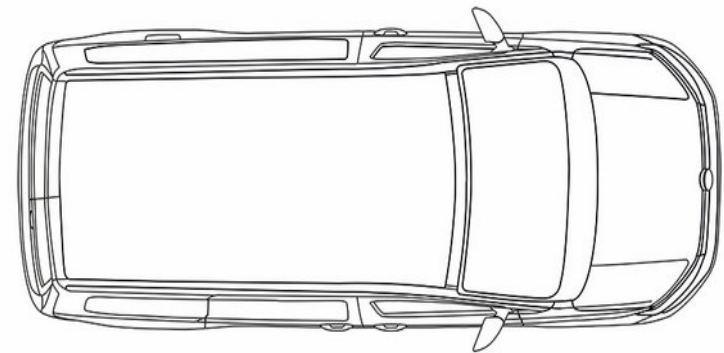
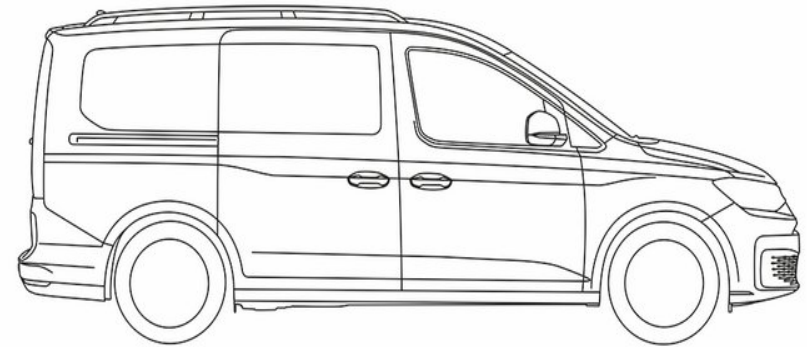



# Caddy Price List

Model	Description	Trimline	RRP (ex VAT)	VRT	VAT	NOx	RRP (incl. VAT)	ROTR (incl Delivery)
SBJT24	2.0 TDI 102HP M6F	Caddy	€ 24,237.61	€ 5,516.75	€ 5,574.64	€ 206.00	€ 35,535.00	€ 36,335.00
SBJT54	2.0 TDI 122HP M6F	Caddy	€ 25,233.39	€ 5,757.84	€ 5,803.77	€ 290.00	€ 37,085.00	€ 37,885.00
SBJT55	2.0 TDI 122HP A7F	Caddy	€ 27,058.20	€ 6,471.20	€ 6,223.60	€ 187.00	€ 39,940.00	€ 40,740.00
SBJK24	2.0 TDI 102HP M6F	Caddy Life	€ 27,352.35	€ 6,221.87	€ 6,291.78	€ 209.00	€ 40,075.00	€ 40,875.00
SBJK54	2.0 TDI 122HP M6F	Caddy Life	€ 28,347.92	€ 6,461.96	€ 6,520.12	€ 290.00	€ 41,620.00	€ 42,420.00
SBJK55	2.0 TDI 122HP A7F	Caddy Life	€ 30,077.54	€ 7,187.68	€ 6,917.78	€ 187.00	€ 44,370.00	€ 45,170.00

Some of the vehicles shown are equipped with special equipment at extra cost. The decorations shown in the images are not included in the standard scope of delivery contain. The information about scope of delivery, appearance, technical data and operating costs of the vehicles correspond to the knowledge available at the time of going to press. All Information regarding equipment and technical data are based on the characteristics of the Irish market.

**Please note that some of the images, sketches or symbolic images shown are due to technical changes or the technical status at the time of Recordings of the actual appearance and / or the circumstances may differ.**

Please also note that some optional extras are subject to certain combination constraints and / or cannot be combined with one another and to certain legal regulations are bound. Volkswagen is expressly not liable for improper use of this equipment.

Some optional extras can lead to a longer delivery time for the vehicle. For the correctness and completeness of the information and the necessary combination requirements are exclusive the available ordering systems from Volkswagen are decisive.

When making changes to the base vehicle, it is essential to observe all applicable statutory vehicle regulations and guidelines (underride protection, lighting equipment, etc.) as well as other relevant regulations z. B. in the environmental sector and vehicle safety.

Equipment can influence the payload or the payload by increasing / reducing the curb weight. The actual Payload of a vehicle resulting from the difference between permissible total weight and curb weight calculated can only be determined by weighing an individual vehicle.

TSI®, TDI®, TGI®, DSG® and 4MOTION® are registered trademarks of Volkswagen AG and other companies in the Volkswagen Group in Germany and in other countries. The fact that a trademark in this document is not marked with ® cannot be interpreted in such a way that this trademark is not a registered trademark and / or that this trademark is without prior written approval of Volkswagen Aktiengesellschaft could be used. The Bluetooth® word mark and logos are owned by the Bluetooth SIG Inc.

Volkswagen AG is not permitted to save any data or to copy all or part of the documents. Volkswagen AG reserves the right in the event of an injury claims for damages in front.

We reserve the right to make changes.

Additional equipment and accessories (attachments, tires, etc.) can be relevant vehicle parameters, such as B. Weight, rolling resistance and aerodynamics, change and in addition to weather and traffic conditions affect consumption and mileage.

# The Caddy

This brochure supersedes all previous publications.

Issue: 01 April 2021

[www.volkswagenvans.ie](http://www.volkswagenvans.ie)

Please note: Screen technology does not allow exact reproduction of the paint and upholstery colours. Some of the vehicles shown are European specification and may be fitted with optional equipment or accessories that are available at extra cost, or do not reflect current specification. All data and specifications are in accordance with information available at the time of publication and are subject to change without notice. Vehicles not currently in Irish stock and customer order vehicles may take a number of weeks for delivery. Certain combinations of vehicle specifications and factory-fitted options are not compatible and therefore all orders received are subject to confirmation. Models, factory fitted-options and paint and upholstery options are subject to availability. Please check details and availability with an authorised Volkswagen Van Centre at the time of ordering.