



RENAULT
PRO+

Renault KANGOO



1st April 2021





Efficient, adaptable and durable

The Renault KANGOO has been specifically designed with your needs in mind, whatever your business environment. With panel vans, crew vans and fully electric versions, the KANGOO can be adapted to your every demand, offering you a wide range of tailor made and practical solutions.



Dashboard storage compartment

R-LINK**

Electrically operated door mirrors

Manual air-conditioning*

USB and AUX ports

Height adjustable steering wheel

Central storage console*

DAB radio and Bluetooth^

Electric front windows

Giving you assistance and control

Here at Renault, nothing is more important to us than your safety and comfort which is why our range of driving assistance systems is more innovative than ever and most come as standard on all our vans!

Rear Parking Sensors*

Parking made all that bit easier with sensors alerting you when your getting close to what's behind you!

Hill Start Assist

No more tricky hill starts as your van will hold you for a couple of seconds to ensure you have time to pull off in gear

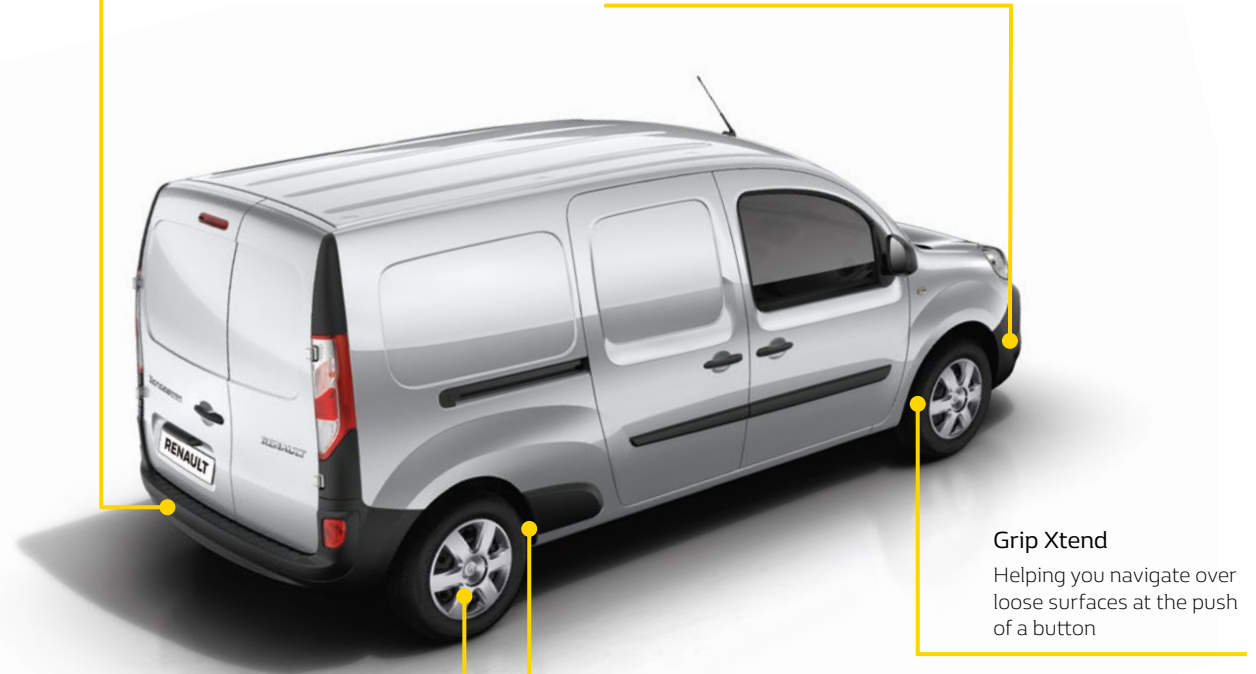

Grip Xtend

Helping you navigate over loose surfaces at the push of a button

16" Steel wheels with large stylers***

Electronic Stability Control

Helps keep you stable in the KANGOO, even when faced with extreme driving conditions

*Standard on Business+ (Manual air conditioning not standard on Business+ Z.E.)

^For compatible devices, please refer to <https://www.renault.co.uk/services/multimedia/bluetooth-compatibility.html>

**R-LINK not currently available to order

***Standard on Business+ and Z.E.



Ergonomic and comfortable workspace

Renault has developed clever solutions to increase practicality whilst improving safety. KANGOO has optimal visibility and ergonomic controls which create a car-like driving position.



Adapted to your team and your load

Multi-positional bulkhead

If you need both crew and load space then this one is for you. You can cleverly make the most of the load length while maintaining passenger safety. When carrying crew the bulkhead sits behind the rear row of seats. When you fold the seats down the bulkhead moves forward to protect you and the front passengers.



Full steel

Standard on all KANGOO panel vans, from top to bottom full steel to protect you and your load.



Swivelling bulkhead

Additionally we offer an optional swivelling bulkhead with folding passenger seat; the passenger seat folds flat and the bulkhead swivels round, providing protection for the driver as well as an additional 0.6m³ of load space. Simple, ingenious, and typical of our attention to detail – giving you a versatile load area.

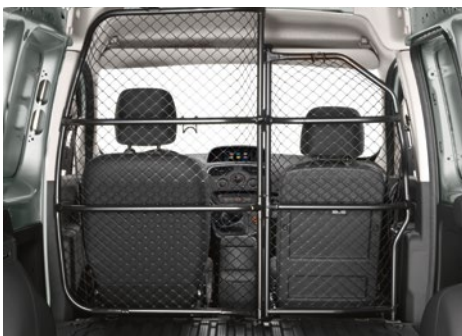

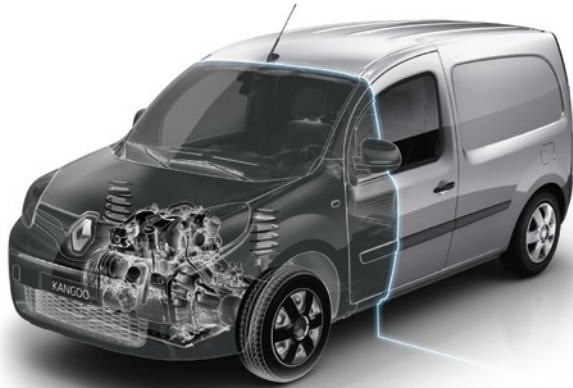

More efficient driving

With our engines your business can benefit from Stop & Start technology and regenerative braking systems. Your Renault KANGOO can achieve fuel economy of up to 50.4mpg*, helping your business minimise fuel costs.

Our range of Euro 6 ENERGY engines offer high performance levels to help your business. Renault is proud to have reduced emissions** in the KANGOO range with the application of the NOx trap located in your exhaust system. This means you can still receive the maximum efficiency from all our engines.



*WLTP figures shown are for comparability purposes; only compare figures with vehicles tested to the same technical procedures. Actual real world driving results may vary depending on factors such as weather conditions, driving styles, vehicle load or any accessories fitted after registration. WLTP is a new test used for fuel consumption and CO₂ figures. Please visit renault.co.uk/configure for WLTP figures for any selected options. KANGOO Energy dCi 80 engine, manual gearbox.

**Compared with Euro 5 engines





Cutting emissions and your costs

Our KANGOO Z.E. is 100% electric, offering you the same generous load capacity of their equivalent diesel versions but with ultra-low running costs and all the benefits of owning a Renault electric vehicle. The quiet yet instant pulling power means your KANGOO Z.E. is simply a pleasure to drive. From easy to charge solutions such as the wallbox* (for home or business recharging) to charging stations at work or local public areas - the benefits simply keep on coming.

* Wall-box not included in purchase

Renault Z.E.

Always a step ahead

Renault has been pushing the boundaries of innovation from revealing the Z.E concept car in 2008, and since then has been a leader in electric vehicle manufacturing in Europe. It has been a priority to fulfil our commitment and continue to develop our technology so that our vehicles stay at the forefront of the electric vehicle market.

First place on the track - first choice on the road

Our commitment to electric motoring innovation runs deeply in Renault's brand DNA. We were a founding partner in Formula E™, the FIA's newest race series. Winning the team championship in 2014/15 and 2015/16 seasons, along with the driver's championship in 2015/16, proves superior electric technology on the track and as one of Europe's best selling EV brands on the road.

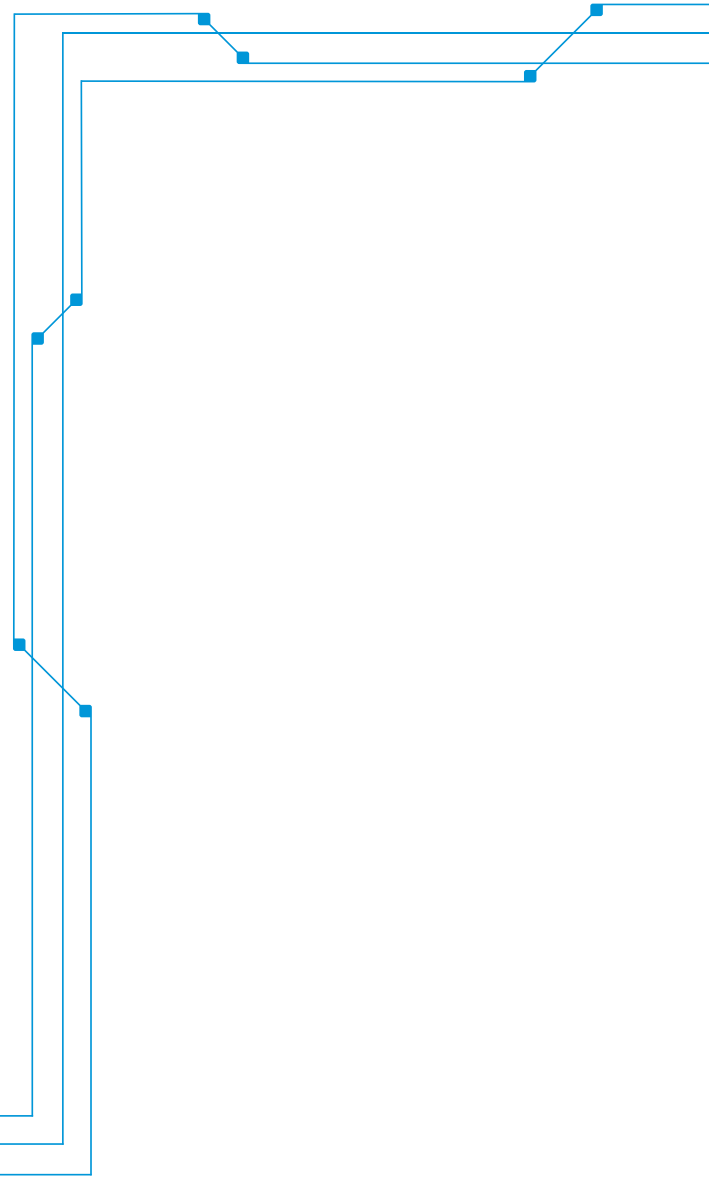

Easy Electric Life

Electric mobility does not have to be more complicated than fuel-powered vehicles.

Far from it, electric power comes as second nature in most areas of our lives - have you ever thought about filling up your smartphone with fuel? Your van does not need to be any different from your phone, simply put it on charge.

Renault PRO+ Electric Vans

Electric isn't just the future, it's right now. That's why our customers have been driving electric vehicles since 2011, and we've since developed the largest model range of electric LCVs in the UK. For you and your business, the result is key. So you'll be pleased to hear that with a Renault PRO+ electric van, you could make significant savings compared to running a diesel or petrol van. Plus, with over 35,000 charging points in the UK, isn't it time for you to join the electric revolution?

It's in our nature

Through supplying the Eden Project in Cornwall with a fleet of 3 ZOE, 13 KANGOO Z.E. and 4 TWIZY, we are supporting them in their mission to connect people with each other and the living world, exploring how we can work together towards a better future.

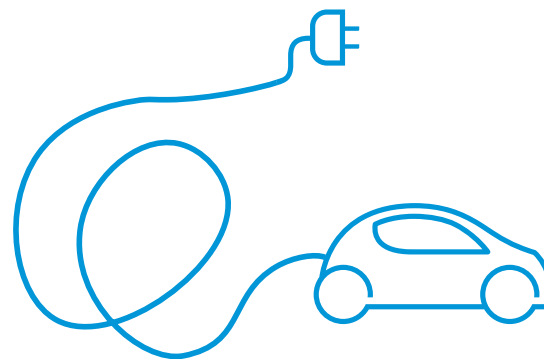



Your 100% controlled driving range



KANGOO Z.E. has 143 miles⁽¹⁾ of driving range in actual use thanks to its lithium-ion Z.E. (33 kWh) battery. The 44 kW power unit offers a torque of 225 Nm and optimum driving comfort. A range of on-board technologies, such as regenerative braking (the battery recharges when the accelerator pedal is released or when the brake pedal is pressed) or the Eco mode (less abrupt acceleration and maximum speed of 50 mph), help optimise your driving range. You can charge your KANGOO Z.E. in just 6 hours with a 32 A/7 kW Wallbox. The recharging flap located on the nose of the vehicle, is easily accessible.

(1) Real-world driving range greater than 75 miles including the most severe use (high load, city centre driving with frequent stops and winter conditions). Actual consumption also depends on the equipment, the driving style of the driver and the elevation profile of the route.

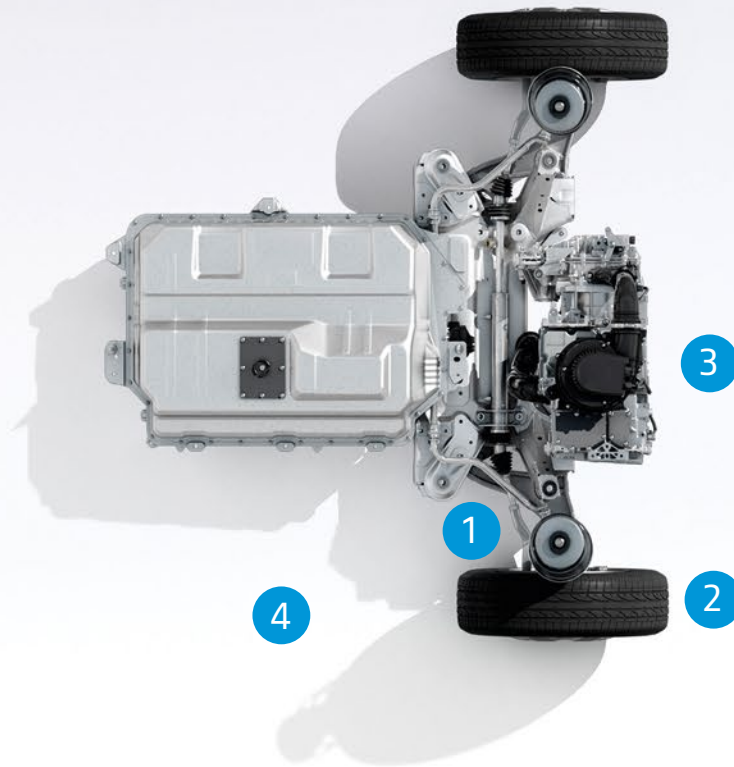

1. Regenerative braking. The battery recharges when you take your foot off the accelerator or when you press on the brake pedal.

2. Low consumption tyres. Their low rolling resistance contributes to conserving your driving range without degrading your road-holding or braking ability.

3. Eco mode. When you activate this, you reduce the power output of the vehicle so that you can travel further (less abrupt acceleration and maximum speed of 50 mph).

4. 7 kW charger. Recharge the battery in just 6 hours with a 32 A/7 kW Wallbox. The recharging flap located on the right-hand side of the cab, is easily accessible.

Driving range

KANGOO Z.E. is now available with the Z.E. Battery giving a revolutionary WLTP* range of 199 miles (city cycle) on one charge, meaning range anxiety is a thing of the past. With real life estimates of 124 miles in summer and 75 miles in winter** the KANGOO Z.E. is able to get you wherever you need to go with less need to recharge on the way, saving you time and money.

WLTP range* Combined cycle (miles)	WLTP range* City cycle (miles)	Summer (+20°C)	Winter** (-5°C)	Cost in Pence p/per mile†	Cost per full recharge†
143	199	124	75	Less than 4p	Less than £5

Top tip: Need an extra boost to get home? The KANGOO charges 15-21 miles on just an hour of charge.

*What is WLTP and why the real-life range is similar to it?

Worldwide Harmonized Light Vehicles Test Procedures (WLTP), this new homologation protocol gives fuel consumption and driving range results that are much closer to real life conditions figures than the NEDC protocol. While the old NEDC test determined test values based on a theoretical driving profile, the WLTP cycle was developed using real-driving data, gathered from around the world. WLTP therefore better represents everyday driving profiles.

**Why is the range reduced in winter?

Like all batteries, those in Z.E. vehicles are less efficient in cold weather than at warmer ambient temperatures. This means that you can expect a reduction in the range of your Renault Z.E. in the winter. Also, in winter you are more likely to use the heating, which means KANGOO Z.E. consumes more energy.

Choose the charging solution for you

Type of charger	Where to use it	Power required	Charging times (0-100%)	
Home (3-pin plug cable)*	Home / Office	2.3kW/10A	17 hours	Occasional slow charging. *Requires additional purchase of a EVSE cable.
	Home / Office	3.3kW/14A	12 hours	
Wallbox / Public charging point	Home / Office / On the go	3.7kW	11 hours	Leaving the KANGOO to charge overnight on a 3.7kW charger ensures that it will be ready for when you to begin your next day.
	Home / Office / On the go	7kW	6 hours	
Public charging point	On the go	22kW	6 hours	A standard charging time of 6 hours means your vehicle is ready to go when you are.
	On the go	43kW	6 hours	

†Less than £5 full recharge cost based on 6 hours of 14.4p per kWh (Source: UK Power) Full recharge of the 33 kWh battery

(1) For illustration purposes only, may not reflect real-life journeys.

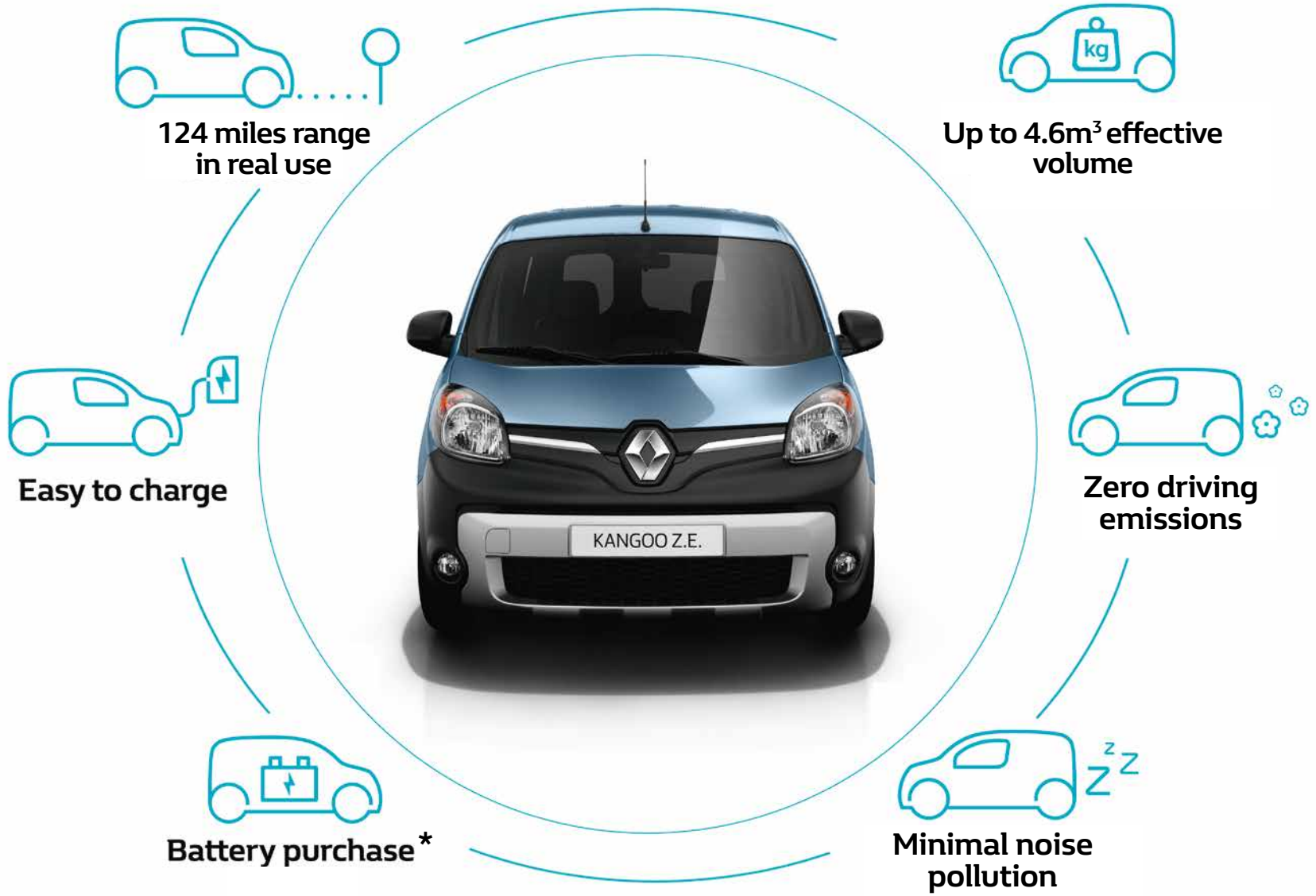

*Battery guarantee of 5 years / 62,000 miles, whichever comes first, this includes the battery performance guarantee to at least 70% of its original capacity.



Standard features

BUSINESS



15" SCRIPT wheels



TANEGA Upholstery



THE BASICS:

- Electrically operated door mirrors
- Electric front windows
- Height adjustable steering wheel
- ABS with EBD (Electronic Brake Force Distribution)
- Alarm (perimeter)
- Height adjustable drivers seat
- Deadlocking
- R.A.I.D (Renault Anti Intruder Device)
- ESC (Electronic Stability Control) with Hill Start Assist and Grip Xtend⁽¹⁾
- Front and rear disc brakes*

MAKING YOUR JOURNEY COMFORTABLE:

- Central storage tray between front seats
- A4 storage in dashboard
- Manual air conditioning with pollen filter (KANGOO and KANGOO Maxi dCi 115 only)

WHAT YOUR VAN LOOKS LIKE:

- 15" SCRIPT wheels
- Dark grey side protection mouldings
- Front and rear dark grey bumpers
- Unglazed 180° asymmetric rear doors
- Unglazed side loading door – left side (KANGOO Van) / left and right side (KANGOO Maxi)

PROTECTING YOU AND YOUR LOAD:

- Anchorage points in load area – 6 on KANGOO and KANGOO Maxi Crew Van / 14 on KANGOO Maxi
- Weight allowed per anchorage point: approximately 500kg
- Spare wheel
- Not available on Crew Van Z.E. and Crew Van Cab Z.E.
- Full steel bulkhead (Not available on KANGOO Crew Vans)
- Tyre repair system (Standard on Crew Van Z.E. and Crew Van Cab Z.E.)

KEEPING YOU CONNECTED:

- 2x15W DAB radio with AUX input, CD, Bluetooth^{®†} and USB connectivity
- Eco mode function
- 12V power socket (front)

GOING ELECTRIC:

- Front Z.E. charging socket
- Standard charging cable 32A (IEC 629196 - Type 2 Mennekes) 6m
- Z.E. voice
- 15" BRIGANTIN wheels (Not available on Crew Van Cab Z.E.)

CREW VAN ADDS:

- Second row of 2 passenger seats (KANGOO Z.E. Crew Van has a second row of 3 passenger seats)
- Interior side panel
- Folding passenger rear seat (1/3 - 2/3)
- Unglazed left and right side loading doors (KANGOO Z.E. Crew Van has glazed side loading doors with opening windows)
- Unglazed left and right side quarter panel
- Unglazed rear doors - 180° asymmetric

CREW VAN CAB ADDS:

- Multipositional bulkhead

* For ML19 ENERGY dCi 80, dCi 95 and dCi 115 versions rear drum brakes are fitted as standard. (1) No Grip Xtend on KANGOO Z.E.

† For compatible devices, please refer to <https://www.renault.co.uk/services/multimedia/bluetooth-compatibility.html>

Standard features

BUSINESS+ (additional equipment to Business)



15" BRIGANTIN wheels



TANEGA Upholstery



MAKING YOUR JOURNEY COMFORTABLE:

- Electrically operated and folding door mirrors
- Electric front windows (driver's side one-touch descending)
- Centre console with armrest
- Overhead parcel shelf
- Load area rubber floor covering
- Manual air conditioning and pollen filter
(Not standard on KANGOO Z.E.)
- Rear parking sensors

PROTECTING YOU AND YOUR LOAD:

- 15" BRIGANTIN wheels
- Front and rear body coloured bumpers and gloss black wing mirrors

GOING ELECTRIC:

- Metallic paint

Colours



MINERAL WHITE ⁽¹⁾
(QNG)



CARMEN RED ^{(1) (3) (4)}
(719)



URBAN GREY ^{(1) (3) (4)}
(KPW)



JET BLACK ⁽²⁾
(GND)



MOCHA ⁽²⁾
(CNB)



HIGHLAND GREY ⁽²⁾
(KQA)



OYSTER GREY ⁽²⁾
(KNG)



NIGHTWATCH BLUE ⁽²⁾
(RNL)

- (1) Non metallic paint
- (2) Metallic paint
- (3) Not available with front and rear body coloured bumpers
- (4) KANGOO Business+ must be ordered with Sport front bumper with silver insert and Front fog lights

	Mineral White QNG	Carmen Red 719	Urban Grey KPW	Jet Black GND	Mocha CNB	Highland Grey KQA	Oyster Grey KNG	Nightwatch Blue RNL
Business	●	●	●	○	○	○	○	○
Business Z.E.	●	●	●	○	○	○	○	○
Business+	●	○	○	○	○	○	○	○
Business+ Z.E.	●	○	○	●	●	●	●	●

● = Standard (therefore no cost) ○ = Optional - = Not available It should be noted that printing limitations do not permit the subtle paintwork shades on these pages to be shown with absolute accuracy.

Wheels



15" SCRIPT wheels



15" BRIGANTIN wheels



15" ARIA ALLOY wheels†

15" SCRIPT wheels

15" BRIGANTIN wheel trims*

15" ARIA alloy wheels†

	KANGOO Van Business	KANGOO Van Business+	KANGOO Maxi Business	KANGOO Maxi Business+	KANGOO Van Z.E. and KANGOO Maxi Van Z.E.
15" SCRIPT wheels	●	-	●	-	-
15" BRIGANTIN wheel trims*	-	●	-	●	●
15" ARIA alloy wheels†	○	○	○	○	-

● = Standard (therefore no cost) ○ = Optional - = Not available † Must be ordered with front & rear disc brakes *BRIGANTIN wheels are not available on Z.E. Crew Van Cab

Wheels and Tyres

TYPE OF TYRES	Euro 6d-Temp emissions standards		
	Summer	All-weather	Z.E. Summer
Tyre/wheel size	195/65 R15	205/55 R16	195/65 R15
Make	Michelin Engery Saver GRNX	Michelin Cross Climate+	Michelin Extra Load Energy Saver +
Fuel efficiency class	E	E	C
Wet grip class	B	E	B
Exterior noise (dB)		70	

KANGOO van pricing

KANGOO VAN - PANEL VAN

VERSIONS	WLTP CO ₂ (g/km) [†]	Combined fuel consumption (mpg) [†]	Load volume (m ³)	Max. payload (kg)	Basic price (£)	VAT 20% (£)	Total retail price (£)*	On the road price*
BUSINESS								
L2H1								
ML19 ENERGY dCi 80 Business	147	50.4	3.0	671	17,650	3,530	21,180	£22,146.00
ML19 ENERGY dCi 95 Business	149	49.6	3.0	671	18,050	3,610	21,660	£22,626.00
L3H1								
LL21 ENERGY dCi 95 Business	155	47.9	4.0	794	19,550	3,910	23,460	£24,426.00
LL21 ENERGY dCi 115 Business	154	47.9	4.0	782	20,250	4,050	24,300	£25,266.00
BUSINESS+								
L2H1								
ML19 ENERGY dCi 95 Business+	156	47.9	3.0	656	18,950	3,790	22,740	£23,706.00
L3H1								
LL21 ENERGY dCi 95 Business+	156	47.9	4.0	779	20,450	4,090	24,540	£25,506.00
LL21 ENERGY dCi 115 Business+	155	47.9	4.0	767	20,900	4,180	25,080	£26,046.00

KANGOO VAN - CREW VAN

VERSIONS	WLTP CO ₂ (g/km) [†]	Combined fuel consumption (mpg) [†]	Load volume (m ³)	Max. payload (kg)	Basic price (£)	VAT 20% (£)	Total retail price (£)*	On the road price*
BUSINESS								
L3H1								
LL21 ENERGY dCi 95 Crew Van Cab Business	156	47.9	2.4	699	20,450	4,090	24,540	£25,506.00
BUSINESS+								
L3H1								
LL21 ENERGY dCi 95 Crew Van Cab Business+	157	47.1	2.4	684	21,350	4,270	25,620	£26,586.00

[†] WLTP figures shown are for comparability purposes; only compare figures with vehicles tested to the same technical procedures. Actual real world driving results may vary depending on factors such as weather conditions, driving styles, vehicle load or any accessories fitted after registration. WLTP is a new test used for fuel consumption and CO₂ figures. Please visit renault.co.uk/configure for WLTP figures for any selected options. *All prices shown are the manufacturer's recommended retail prices. The "On The Road" price includes delivery to the dealer premises, number plates and a four-litre starter pack of AdBlue®, 12 months government road fund licence at £275 (or £165 for vans with a GVW of more than 3.5 tonnes) and the First Registration Fee of £55. Other goods or services supplied by agreement between the customer and the dealer are not included.

LCV SERVICE PLAN

5 Years / 66,000 miles

MRRP (inc VAT)

£1,075

LCV EXTENDED WARRANTY

5 Years / 100,000 miles

MRRP (inc VAT)

£485

Service Plan Terms & Conditions The Service Plan offer is available on all LCV's. Valid at participating Renault dealers only and may be purchased up to 12 months after registration or before the first service (whichever is sooner). Vehicles must be ordered between 8 March 2021 and 30 June 2021 and registered by 30 September 2021.

The Renault Service plan covers the manufacturer's minimum maintenance programme requirements for the term of the Service Plan purchased (refer to the Warranty and Service sheet in the Handover Document wallet for details). The plan ends when you reach the age or mileage limit (whichever comes first). Services must be carried out in line with the manufacturer's minimum maintenance programme requirements and servicing intervals within +/-1 month or 1,000 miles of the service interval and can only be carried out at a Renault Approved outlet. Service plans do not cover wear and tear items such as (but not limited to) tyres, wiper blades or brakes. For Service plan full Terms & Conditions visit www.renault.co.uk/owners. Cannot be part exchanged, refunded or transferred. All prices quoted are MRRP.

Extended Warranty Terms & Conditions The Extended Warranties are available on all LCV's (excluding ZOE Van). Valid at participating Renault dealers only and are available to purchase from first date of registration and may be purchased up to 12 months after registration. For full Extended Warranty Terms and Conditions visit www.renault.co.uk/extensions-of-warranties

KANGOO Z.E. pricing

To make KANGOO Z.E. ownership as easy as possible, all KANGOO Z.E. now come with the battery included.

KANGOO i Z.E. - Battery Purchase



- No on-going monthly payments, just one simple payment.
- No mileage limit in the battery contract.
- Battery guarantee*** of 5 years / 62,000 miles, whichever comes first, this includes the battery performance guarantee to at least 70% of its original capacity.
- Roadside assistance, breakdown only

KANGOO VAN Z.E.

VERSIONS	WLTP CO ₂ (g/km)	Power unit output kW (bhp)	Load volume (m ³)	Max. payload (kg)†	Basic price (£)	VAT 20% (£)	Total retail (£)*	Government grant (£)	Basic price after PiVG* exc VAT	Total retail price after PiVG**	On the road price after PiVG***
PANEL VAN BUSINESS											
L2H1											
ML20 i Z.E. Business	0	44 (60)	3.0	625	26,000	5,200	31,200	3,000	£23,000	£28,200	£28,891
L3H1											
LL21 i Z.E. Business	0	44 (60)	4.0	605	27,500	5,500	33,000	3,000	£24,500	£30,000	£30,691
PANEL VAN BUSINESS +											
L2H1											
ML20 i Z.E. Business+	0	44 (60)	3.0	625	26,600	5,320	31,920	3,000	£23,600	£28,920	£29,611
L3H1											
LL21 i Z.E. Business+	0	44 (60)	4.0	605	28,100	5,620	33,720	3,000	£25,100	£30,720	£31,411
CREW VAN BUSINESS											
L3H1											
LL21 i Z.E. Crew Van Business	0	44 (60)	1.3	640	28,400	5,680	34,080	3,000	£25,400	£31,080	£31,771
CREW VAN CAB BUSINESS											
L3H1											
LL21 i Z.E. Crew Van Cab Business	0	44 (60)	2.4	639	29,400	5,880	35,280	3,000	£26,400	£32,280	£32,971

* PiVG - Plug-In Van Grant. ** All prices shown are the manufacturer's recommended retail prices. i - Indicates with full battery purchase. ***For full terms and conditions visit www.renault.co.uk/warranty. The "On The Road" price includes delivery to the dealer premises, 35% PiVG (up to a maximum of £3,000 for small vans weighing less than 2.5 tonnes), number plates, 12 months government road fund licence at £275 (or £0 for KANGOO Z.E.) and First Registration Fee at £55. Other goods or services supplied by agreement between the customer and the Dealer are not included. † Payload equals the Maximum Operating Mass (Gross Vehicle Mass or GVW) less the Kerb Mass. Kerb Mass is the weight of the complete vehicle including coolant, oil, the battery, spare wheel and jack, but excluding driver and crew. All Kerb Masses, and therefore Payloads quoted are subject to a 5% manufacturing tolerance and are based on the base level model. Any additional equipment added (options or accessories), or the selection of a higher trim level, could result in a higher Kerb Mass and a reduced Payload, and may increase weight and decrease range figures.

LCV SERVICE PLAN

5 Years / 66,000 miles

MRRP (inc VAT)

£750

LCV EXTENDED WARRANTY

5 Years / 96,000 miles

MRRP (inc VAT)

£540

Service Plan Terms & Conditions The Service Plan offer is available on all LCVs. Valid at participating Renault dealers only and may be purchased up to 12 months after registration or before the first service (whichever is sooner). Vehicles must be ordered between 8 March 2021 and 30 June 2021 and registered by 30 September 2021.

The Renault Service plan covers the manufacturer's minimum maintenance programme requirements for the term of the Service Plan purchased (refer to the Warranty and Service sheet in the Handover Document wallet for details). The plan ends when you reach the age or mileage limit (whichever comes first). Services must be carried out in line with the manufacturer's minimum maintenance programme requirements and servicing intervals within +/-1 month or 1,000 miles of the service interval and can only be carried out at a Renault Approved outlet. Service plans do not cover wear and tear items such as (but not limited to) tyres, wiper blades or brakes. For Service plan full Terms & Conditions visit www.renault.co.uk/owners. Cannot be part exchanged, refunded or transferred. All prices quoted are MRRP.

Extended Warranty Terms & Conditions The Extended Warranties are available on all LCVs (excluding ZOE Van). Valid at participating Renault dealers only and are available to purchase from first date of registration and may be purchased up to 12 months after registration. For full Extended Warranty Terms and Conditions visit www.renault.co.uk/extensions-of-warranties

KANGOO options pricing

	BUSINESS			BUSINESS+			BUSINESS Z.E.			BUSINESS+ Z.E.		Basic price (£)	VAT 20% (£)	MRRP*
	MWB	LWB	Crew Van	MWB	LWB	Crew Van	MWB	LWB	Crew Van	MWB	LWB			
BASICS														
Increased payload (max. 800kg) ^{(4) (6)}	○	-	-	○	-	-	-	-	-	-	-	150	30	£180
Interior side door panel	○	○	●	○	○	●	○	○	●	○	○	80	16	£96
Rear disc brakes ⁽³⁾	○	●	●	○	●	●	●	●	●	●	●	150	30	£180
Tow bar (13-pin)	○	○	○	○	○	○	-	-	-	-	-	500	100	£600
Tyre repair kit (standard on Crew Van Z.E. versions)	○	○	○	○	○	○	○	○	●	○	-	No cost option		
SAFETY														
Airbag - front passenger ⁽⁵⁾	○	○	○	○	○	○	○	○	○	○	○	235	47	£282
Airbag - front lateral (thorax) & front passenger	○	○	○	○	○	○	○	○	○	○	○	385	77	£462
2 Additional anchorage points in loading area, weight allowed per anchorage point: approximately 500kg	○	●	-	○	●	-	○	●	-	○	●	75	15	£90
All-weather tyres ⁽¹²⁾	○	-	-	○	-	-	-	-	-	-	-	300	60	£360
Automatic headlights and wipers with front fog lights	○	○	○	○	○	○	○	○	○	○	○	210	42	£252
Bulkhead - fixed grille on the back of rear seats (Crew Van only) ⁽¹⁷⁾	-	-	-	-	-	-	-	-	○	-	-	170	34	£204
Bulkhead - multipositional (Crew Van only) - (optional on Crew Van and standard on Crew Van Cab versions)	-	-	○	-	-	○	-	-	○	-	-	1,175	235	£1,410
Bulkhead - swivelling with folding passenger seat	○	○	-	○	○	-	○	○	-	○	○	230	46	£276
Bulkhead - tubular	○	○	-	○	○	-	○	○	-	○	○	No cost option		
Front fog lights	○	○	○	○	○	○	○	○	○	○	○	150	30	£180
Load area rubber floor covering	○	○	○	●	●	●	○	○	○	●	●	95	15	£90
Tyre pressure monitoring system	○	○	○	○	○	○	-	-	-	-	-	100	20	£120
COMFORT														
Central console with plastic armrest	○	○	○	●	●	●	○	○	○	○	●	50	10	£60
Climate control with automatic headlight and wipers ⁽¹⁰⁾⁽¹⁷⁾	-	-	-	○	○	○	-	-	-	-	-	900	180	£1,080
Cruise control with speed limiter	○	○	○	○	○	○	○	○	○	○	○	210	42	£252
Electric front windows - driver's side one-touch descending	○	○	○	●	●	●	○	○	○	●	●	50	10	£60
Engine speed limiter (56mph OR 62mph OR 68mph)	○	○	○	○	○	○	○	○	○	○	○	65	13	£78
Leather steering wheel	-	-	-	○	○	○	-	-	-	○	○	60	12	£72
Manual air conditioning with pollen filter ⁽¹¹⁾	○	○	○	●	●	●	-	-	-	-	-	655	131	£786
Overhead parcel shelf	○	○	○	●	●	●	○	○	○	●	●	75	15	£90
Rear parking sensors	○	○	○	●	●	●	○	○	○	●	●	220	44	£264
Smoker pack	○	○	○	○	○	○	○	○	○	○	○	20	4	£24
STYLE														
15" ARIA alloy wheels	○	○	○	○	○	○	-	-	-	-	-	350	70	£420
Extra tinted glass in rear windows	○	○	○	○	○	○	-	-	-	-	-	50	10	£60
Metallic paint	○	○	○	○	○	○	○	○	○	●	●	450	90	£540
Sport front bumper with silver insert ⁽¹⁸⁾⁽²¹⁾	○	○	○	○	○	○	○	○	○	○	○	50	10	£60
Standard bumper	●	●	●	○	○	○	●	●	●	○	○	No cost option		
ELECTRIC														
Additional heating unit ⁽¹⁶⁾	-	-	-	-	-	-	○	○	-	○	○	900	180	£1,080
EVSE Cable for 10 amp charging for domestic 3-pin plug	-	-	-	-	-	-	○	○	○	○	○	415	83	£498
Manual air conditioning and pollen filter with heat pump	-	-	-	-	-	-	○	○	○	○	○	1,200	240	£1,440

● = Standard (therefore no cost) ○ = Optional - = Not available #Manufacturer's recommended retail prices.

(1) For list of compatible Bluetooth devices visit <https://www.renault.co.uk/services/multimedia/bluetooth-compatibility.html> (2) Please note for Crew Van only, ordering glazed side loading doors could make your vehicle liable for VAT. You are advised to contact your local tax authority (3) Only available as an option on ML19 (4) Standard on ML20 and LL21 versions (5) Can be deactivated (6) Must be ordered with rear disc brakes (7) Not available on Crew Van Cab (8) Not available on KANGOO Z.E. Must be taken with mud and snow tyres (9) Can only be ordered with Renault R-LINK Evolution multimedia system (10) Not available with full-steel bulkhead (11) Standard on dCi 115 versions (12) Not compatible with ML20 versions and with alloy wheels (will be replaced by new tyres) (13) Not available in Carmen Red (14) Must be taken with glazed side loading doors (15) Not compatible with auto closing doors and proximity radar type 4 (16) Not compatible with multipositional bulkhead and Crew Van Cab versions (17) Replaces manual air conditioning (18) Must be taken with front fog lights (19) Requires overhead parcel shelf (20) Not compatible with sports bumper (21) Not compatible with body-coloured bumper

Doors and windows

	KANGOO			KANGOO Z.E.			Basic price (£)	VAT 20% (£)	MRRP*
	MWB	LWB	Crew Van	MWB	LWB	Crew Van			
Right side loading door - unglazed	○	●	●	-	●	-	200	40	£240
Glazing for left and right side loading doors non opening windows each (for both sides) ⁽¹⁾	○	○	○	-	○	-	50 (100)	10 (20)	£60 (120)
Opening windows for left and right glazed side loading doors	○	○	○	-	-	●	50	10	£60
Glazed rear quarter panels	○	○	○	-	○	○	75	15	£90
Rear doors - 180° glazed with rear wipers and rear heated window	○	○	○	○	○	○	200	40	£240
Rear tailgate - glazed with rear wipers and rear heated window	○	-	-	○	-	-	205	41	£246

● = Standard (therefore no cost) ○ = Optional - = Not available

* All prices shown are the manufacturer's recommended retail prices. (1) Not available on Crew Van Cab Z.E.

Please note for Crew Van only, ordering glazed side loading doors could make your vehicle liable for VAT. You are advised to contact your local tax authority



Dimensions - KANGOO Van & Z.E.

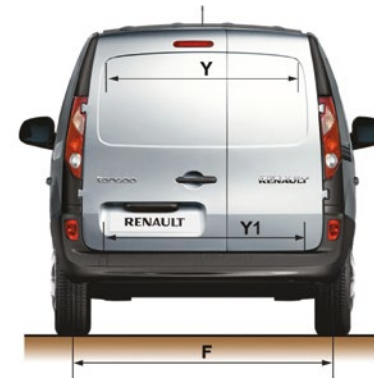
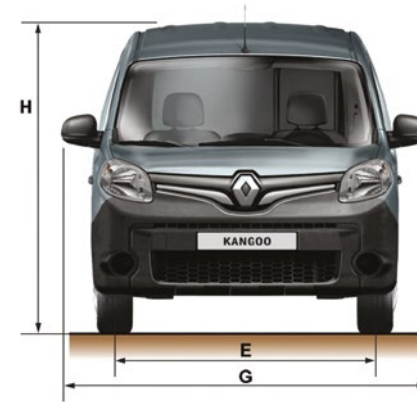
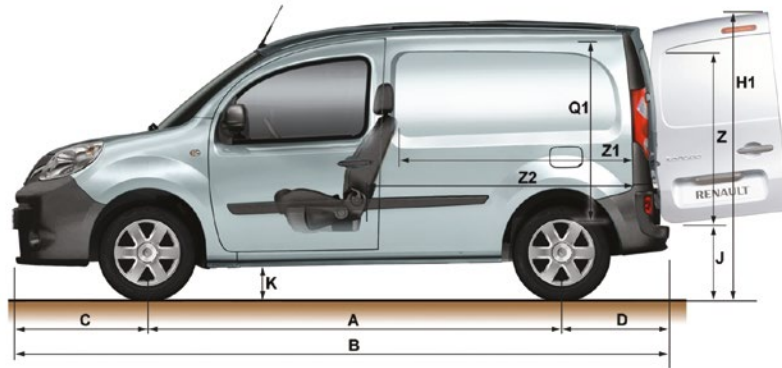

DIMENSIONS (mm)

Payload diesel/electric	656kg - 786kg / 625kg
Load volume diesel/electric	3.0/3.6m ³ ^/3.6m ³ ^
A Wheelbase	2,697
B Overall length	4,282
C Front overhang	875
D Rear overhang	710
E Front track width	1,521
F Rear track width	1,534
G Overall width (without mirrors)	1,829
G1 Overall width (with mirrors)	2,138
H Unladen height	1,805 to 1,844
H1 Height with opened rear doors	1,872 to 1,934

J Sill Height	588 to 609
K Ground Clearance (unladen)	157 to 210
K1 Ground Clearance (laden)	143 to 172
M Elbow room	1,510
N Front interior width	1,464
Q1 Rear interior height	1,251
Y Rear width- top	1,141
Y1 Rear width-bottom	1,219
Y2 Width between wheel arches	1,218
Z Loading height	1,129
Z1 Loading length	1,476
Z2 Loading length at floor / with option folding passenger seat	1,731 / 2,502

^Payload equals the Maximum Operating Mass (Gross Vehicle Mass or GVW) less the Kerb Mass, Kerb Mass is the weight of the complete vehicle including coolant, oil, a 90% full fuel tank, spare wheel and jack, but excluding driver and crew. All Kerb Masses, and therefore Payloads quoted are subject to a 5% manufacturing tolerance and are based on the base level model. Any additional equipment added (options or accessories), or the selection of a higher trim level, can result in a higher Kerb Mass and reduced Payload, and may increase CO₂ and decrease MPG figures.

Technical Specifications - KANGOO Van

	ENERGY dCi 80	ENERGY dCi 95	ENERGY dCi 115
ENGINE			
Engine type		K9K	
Injection type		Direct (Turbo) Common Rail	
Fuel type		Diesel	
Number of cylinders		4	
Number of valves		8	
Particle Filter		Yes	
Max engine power kW (hp)	59 (80) at 3,750	70 (95) at 3,750	85 (115) at 3,750
Max torque Nm (rpm)	210 (1,750)	230 (1,750)	260 (1,750)
GEARBOX			
Type	TL4	TL4	TL4
Number of Forward Gears	6	6	6
Vehicle speeds (mph) at 1000 rpm: in 1st gear	4.6	4.6	4.6
Vehicle speeds (mph) at 1000 rpm: in 2nd gear	8.8	8.8	8.8
Vehicle speeds (mph) at 1000 rpm: in 3rd gear	14.0	14.0	14.0
Vehicle speeds (mph) at 1000 rpm: in 4th gear	20.4	20.4	20.4
Vehicle speeds (mph) at 1000 rpm: in 5th gear	26.2	26.2	26.2
Vehicle speeds (mph) at 1000 rpm: in 6th gear	30.6	30.6	30.6
Reverse	4.6	4.6	4.6
STEERING			
Turning circle between kerbs		10.7	
Turns lock-to-lock (PAS)		3.2	
DRIVE TRAIN			
Type		Traction	
TYRES			
Tyre size (ML19/ML20)		195/65 R15 91T/95T	
BRAKING SYSTEM			
Front disc brakes (mm) (Diameter/Thickness)	280/24	280/24	280/24
Rear drum (T) or disc (mm) (Diameter/Thickness)	T9"	T9"	274/11
Vehicle with increased payload Front disc brakes (mm) (Diameter/Thickness)	-	280/24	280/24
Vehicle with increased payload Rear disc brakes (mm) (Diameter/Thickness)	-	274/11	274/11
PERFORMANCE			
Maximum speed (mph)	96	102	109
Acceleration 0-62 mph std veh. (s)	15.2	12.3	9.9
FUEL CONSUMPTION AND EMISSIONS*			
WLTP CO ₂ Emissions (g/km)	147	149-157	147-156
Combined fuel consumption (mpg)	50.4	49.6-47.1	50.4-47.9
FUEL TANK CAPACITY			
Fuel tank capacity - gallons (l)		13.2 (60)	
AdBlue® tank capacity (l) **		17.4	
BIO-FUEL / HVO			
BIO-fuel type		B7, B8, B10, XTL	
HVO type		HVO100 compliant	
WEIGHT (KG)			
Kerb weight (min./max.)	1,309	1,309 / 1,314	1,320 / 1,325
Gross vehicle weight	1,980	1,980	1,980
Gross train weight	3,030	3,030 / 3,150	3,030 / 3,150
Average maximum payload [†]	671	671	660
Roof payload		100	
Unbraked trailer capacity	690	690	695 / 700
Braked trailer capacity	1,050	1,050	1,050
SERVICING INTERVALS			
Service Intervals		18,000 miles / 2 years	
WARRANTY			
Warranty		Warranty and road side assistance ; 3 Years. Unlimited for first 24 months, then limited to a total of 100,000 miles or 3 years, whichever comes first	

*WLTP figures shown are for comparability purposes; only compare figures with vehicles tested to the same technical procedures. Actual real world driving results may vary depending on factors such as weather conditions, driving styles, vehicle load or any accessories fitted after registration. WLTP is a new test used for fuel consumption and CO₂ figures. Please visit renault.co.uk/configure for WLTP figures for any selected options. **Actual fuel and AdBlue® consumption depends on vehicle use, equipment, the user's driving style and loading. [†]Payload equals the Maximum Operating Mass (Gross Vehicle Mass or GVW) less the Kerb Mass. Kerb Mass is the weight of the complete vehicle including coolant, oil, a 90% full fuel tank, spare wheel and jack, but excluding driver and crew. All Kerb Masses, and therefore Payloads quoted are subject to a 5% manufacturing tolerance and are based on the base level model. Any additional equipment added (options or accessories), or the selection of a higher trim level, could result in a higher Kerb Mass and a reduced Payload, and may increase CO₂ and decrease MPG figures.

Dimensions - KANGOO Maxi & Z.E.



DIMENSIONS (mm)	Maxi Panel Van	Maxi Crew Van	Maxi Crew Van with multi positional bulkhead
Average Payload diesel/electric	779kg - 794kg / 605kg	684kg - 699kg / 640kg	684kg - 699kg / 639kg
Load volume diesel/electric	4.0m ³ to 4.6m ³ / 4.6m ³	1.3m ³ to 3.4m ³ / 3.4m ³	2.4m ³ to 3.6m ³ / 3.6m ³
A Wheelbase	3,081	3,081	3,081
B Overall length	4,666	4,666	4,666
C Front overhang	875	875	875
D Rear overhang	710	710	710
E Front track width	1,521	1,521	1,521
F Rear track width	1,533	1,533	1,533
G Overall width (without mirrors)	1,829	1,829	1,829
G1 Overall width (with mirrors)	2,138	2,138	2,138
H Unladen height	1,810 to 1,836	1,802 to 1,826	1,802 to 1,826
H1 Height with opened rear doors	1,893 to 1,920	1,878 to 1,902	1,878 to 1,902
J Sill Height	575 to 601	563 to 586	563 to 586
K Ground Clearance (unladen)	170 to 212	170 to 212	170 to 210
K1 Ground clearance (laden)	145 to 172	145 to 172	150 to 172
M Elbow room (front/rear)	1,510 / -	1,510 / 1,539	1,510 / 1,539
N Front interior width (front/rear)	1,464 / -	1,464 / 1,507	1,464 / 1,507
Q1 Rear interior height	1,252	1,154	1,154
Y Rear width- top	1,141	1,141	1,141
Y1 Rear width-bottom	1,219	1,219	1,219
Y2 Width between wheel arches	1,218	1,145	1,145
Z Loading height	1,129	1,129	1,129
Z1 Loading length	1,862	1,008	1,361
Z2 Loading length at floor / with option folding passenger seat	2,115 / 2,886	1,328 / 2,210	1,432 / 2,043

^Payload equals the Maximum Operating Mass (Gross Vehicle Mass or GVW) less the Kerb Mass. Kerb Mass is the weight of the complete vehicle including coolant, oil, a 90% full fuel tank, spare wheel and jack, but excluding driver and crew. All Kerb Masses, and therefore Payloads quoted are subject to a 5% manufacturing tolerance and are based on the base level model. Any additional equipment added (options or accessories), or the selection of a higher trim level, can result in a higher Kerb Mass and reduced Payload, and may increase CO₂ and decrease MPG figures.

Technical Specifications - KANGOO Maxi

	MAXI PANEL VAN		CREW VAN
	ENERGY dCi 95	ENERGY dCi 115	ENERGY dCi 95
ENGINE			
Engine type	K9K		K9K
Injection type	Direct (Turbo) Common Rail		
Fuel type	Diesel		
Number of cylinders	4		
Number of valves	8		
Particle Filter	Yes		
Max engine power kW (hp)	70 (95) at 4,000	85 (115) at 4,000	70 (95) at 4,000
Max torque Nm (rpm)	230 (1,750)	260 (1,750)	230 (1,750)
GEARBOX			
Type	TL4	TL4	TL4
Number of Forward Gears	6	6	6
Vehicle speeds (mph) at 1000 rpm: in 1st gear	4.6	4.6	4.6
Vehicle speeds (mph) at 1000 rpm: in 2nd gear	8.8	8.8	8.8
Vehicle speeds (mph) at 1000 rpm: in 3rd gear	14.0	14.0	14.0
Vehicle speeds (mph) at 1000 rpm: in 4th gear	20.4	20.4	20.4
Vehicle speeds (mph) at 1000 rpm: in 5th gear	26.2	26.2	26.2
Vehicle speeds (mph) at 1000 rpm: in 6th gear	30.6	30.6	30.6
Reverse	4.6	4.6	4.6
STEERING			
Turning circle between kerbs			10.7
Turns lock-to-lock (PAS)			3.2
DRIVE TRAIN			
Type	Traction		
TYRES			
Tyre size	195/65 R15 95T		
BRAKING SYSTEM			
Front disc brakes (mm) (Diameter/Thickness)	280/24		
Rear disc brakes (mm) (Diameter/Thickness)	274/11		
PERFORMANCE			
Maximum speed (mph)	101	108	101
Acceleration 0-62 mph std veh. (s)	12.3	12.3	12.3
FUEL CONSUMPTION AND EMISSIONS*			
WLTP CO ₂ Emissions (g/km)	122	125	126
Combined fuel consumption (mpg)	61.4	58.9	58.9
FUEL TANK CAPACITY			
Fuel tank capacity - gallons (l)	13.2 (60)		
AdBlue® tank capacity (l)**	17.4		
BIO-FUEL / HVO			
BIO-fuel type	B7, B8, B10, XTL		
HVO type	HVO100 compliant		
WEIGHT (KG)			
Kerb weight	1,406	1,418	1,476
Gross vehicle weight	2,200	2,200	2,175
Gross train weight	3,250	3,250	3,225
Average maximum payload [^]	794	782	699
Roof payload	100		
Unbraked trailer capacity	740	745	740
Braked trailer capacity	1,050	1,050	1,050
SERVICING INTERVALS			
Service Intervals	18,000 miles / 2 years		
WARRANTY			
Warranty	Warranty and road side assistance ; 3 Years, Unlimited for first 24 months, then limited to a total of 100,000 miles or 3 years, whichever comes first		

*WLTP figures shown are for comparability purposes; only compare figures with vehicles tested to the same technical procedures. Actual real world driving results may vary depending on factors such as weather conditions, driving styles, vehicle load or any accessories fitted after registration. WLTP is a new test used for fuel consumption and CO₂ figures. Please visit reault.co.uk/configure for WLTP figures for any selected options. **Actual fuel and AdBlue® consumption depends on vehicle use, equipment, the user's driving style and loading. [^]Payload equals the Maximum Operating Mass (Gross Vehicle Mass or GVW) less the Kerb Mass. Kerb Mass is the weight of the complete vehicle including coolant, oil, a 90% full fuel tank, spare wheel and jack, but excluding driver and crew. All Kerb Masses, and therefore Payloads quoted are subject to a 5% manufacturing tolerance and are based on the base level model. Any additional equipment added (options or accessories), or the selection of a higher trim level, could result in a higher Kerb Mass and a reduced Payload, and may increase CO₂ and decrease MPG figures.

Technical Specifications - KANGOO Z.E.

	KANGOO VAN Z.E.	KANGOO MAXI Z.E.	KANGOO MAXI CREW VAN Z.E.	KANGOO MAXI CREW VAN CAB Z.E.
BATTERY				
Battery type		Lithium-Nickel-Manganese-Cobalt (LiMnCoO)		
Battery weight (kg)		260kg		
Fuel type		Electric		
Max engine power kW (hp)		44 Kw / 60 hp		
Max Torque (nm)		225		
RANGE				
Range (NEDC) miles		170		
Range (WLTP) miles		143		
Range in temperate conditions (+20°C) (miles/km)		124 / 199		
Extreme winter conditions (-5°C) (miles/km)		75 / 120		
Extreme winter conditions (-5°C) with air-con & heat pump (miles/km)		84 / 135		
Extreme winter conditions (-5°C) with external heater (with or without air-con & heat pump) (miles/km)		99 / 160		
DRIVE TRAIN				
Type		Traction		
Motor and drive train features		Synchronous with rotor coil		
TYRES				
Tyre size		195/65 R15 95T (Energy Saver)		
BREAKING SYSTEM				
Front disc brakes (mm) (diameter/thickness)		280/24		
Rear disc brakes (mm) (diameter/thickness)		274/11		
PERFORMANCE				
Maximum Speed mph		81		
0-62mph (sec)	20.6	22.3	22.3	22.3
FUEL CONSUMPTION*				
Electricity consumption (kWh/mi)		245		
BATTERY CAPACITY				
Battery Capacity (kWh)		33		
WEIGHT (KG)				
Kerb weight - empty without option	1505	1585	1630	1631
Gross vehicle weight	2130	2190	2270	2270
Gross train weight	2504	2512	2270	2270
Payload ^Δ	625	605	640	639
Roof payload		100		
Towing		Not permitted		
SERVICING INTERVALS				
Service Intervals		Z.E. Services - 1st Year / 12,000 miles 2nd Year / 24,000 miles then every 24,000 miles or 2 years after that		
WARRANTY				
Warranty		Warranty and road side assistance ; 3 Years. Unlimited for first 24 months, then limited to a total of 100,000 miles or 3 years, whichever comes first		

*WLTP figures shown are for comparability purposes; only compare figures with vehicles tested to the same technical procedures. Actual real world driving results may vary depending on factors such as weather conditions, driving styles, vehicle load or any accessories fitted after registration. WLTP is a new test used for fuel consumption and CO₂ figures. Please visit renault.co.uk/configure for WLTP figures for any selected options. ^ΔPayload equals the Maximum Operating Mass (Gross Vehicle Mass or GVW) less the Kerb Mass. Kerb Mass is the weight of the complete vehicle including coolant, oil, spare wheel and jack, but excluding driver and crew. All Kerb Masses, and therefore Payloads quoted are subject to a 5% manufacturing tolerance and are based on the base level model. Any additional equipment added (options or accessories), or the selection of a higher trim level, could result in a higher Kerb Mass and a reduced Payload, and may increase CO₂ and decrease MPG figures.

Accessories

Kangoo Van comes equipped with a full height steel bulkhead as standard



1. Ply lining

Protect the interior of your new KANGOO with our hardwearing, bespoke Ply Lining. The price includes fitment by Renault.

2. Kenwood Dashcam

The Kenwood DVR-A501W dashcam is a great addition for added security and reassurance on the road.

3. 3-Pin Domestic Charging Cable

Keep your KANGOO Z.E. charged at a standard socket, no need to worry about having to charge without a charging station.

4. Roof Bars

Very practical for transporting professional equipment and all other bulky loads. These roof bars meet all safety and quality standards.

5. Rear Body Coloured Parking Sensors

Allows you to park with confidence. Not compatible with factory fit parking sensors .

Accessories are fitted post-production and may have an impact on real world fuel (actual) consumption and CO₂ figures.

For more information and additional accessories, consult the KANGOO accessories brochure.



2.



3.



4.



5.

KANGOO van accessory pricing

	Basic price (£)	MRRP*
CHEVRONS		
Full rear chevrons	366.67	£440
Full rear chevrons without window panel	250	£300
Lower half height chevrons	241.67	£290
SAFETY		
Deadlock kit - front door	150	£180
Deadlock kit - passenger front door	150	£180
Deadlock kit - side loading door	150	£180
Deadlock kit - passenger side side loading door	150	£180
Deadlock kit - glazed side loading door	150	£180
Deadlock kit - glazed passenger side side loading door	150	£180
Deadlock kit - rear door	150	£180
Deadlock 4 door set - driver, passenger, side loading, rear doors	415.83	£499
Deadlock 2 door set - side loading, rear doors	258.33	£310
Slamlock 2 door set - side loading, rear doors	220	£264
Protektaplate 4 door set - driver, passenger, side loading, rear doors	300	£360
Protektaplate 2 door set - side loading, rear doors	230	£276
Armourshell 2 door mini set - side loading, rear door - black	340	£408
Alarm	183.33	£220
Kenwood dashcam	208.33	£250
MULTIMEDIA		
Focal music speakers 4.0	180	£216
TRANSPORT & TOWING		
Transversal roof bars	140	£168
Roof rack L1	325	£390
Roof rack L2	458.33	£550
Towing kit - fixed tow bar and wiring loom	271.67	£326
READY 4 WORK		
Standard storage system – includes standard offside racking with safety floor	829.17	£995
PROTECTION		
Ply lining - KANGOO van MWB	140.83	£169
Ply lining - KANGOO van LWB	149.17	£179
Ply lining - KANGOO crew van LWB	140.83	£169
Ply lining - KANGOO Z.E. MWB	140.83	£169
Ply lining - KANGOO Z.E. LWB	149.17	£179
Ply lining KANGOO Z.E. Crew LWB	140.83	£169
Rear window protection grilles	125	£150
Rear body coloured parking sensors	245.83	£295
Front body coloured parking sensors ⁽¹⁾	258.33	£310
Rubber mats	41.67	£50
Textile mats	37.50	£45
Z.E.		
Charging cable 10A, domestic use (3 pin)	395.83	£475

* Manufacturer's Recommended Retail Price. (1) Not compatible with factory fit rear parking sensors. Accessory prices shown are only valid for vehicles which will have the accessories fitted at the manufacturers import centre. Your local dealer will be able to offer further advice and supply a dealer fitted price for vehicles already in dealer stock. Accessories are fitted post-production, and may have an impact on real world fuel (actual) consumption and CO₂ figures.

Further information

Vehicle	Classed As	Delivery to Dealer and Number Plates*	Vehicle Excise Duty	First Registration Fee	Total
KANGOO Van	LCV	£636	£275	£55	£966
KANGOO Maxi and Crew Van	LCV	£636	£275	£55	£966
KANGOO Van Z.E. / KANGOO Maxi and Crew Van Z.E.	LCV	£636	£0	£55	£691

Information correct at time of publication * Inc VAT † WLTP figures shown are for comparability purposes; only compare figures with vehicles tested to the same technical procedures. Actual real world driving results may vary depending on factors such as weather conditions, driving styles, vehicle load or any accessories fitted after registration. WLTP is a new test used for fuel consumption and CO2 figures. Please visit renault.co.uk/configure for WLTP figures for any selected options.

Renault PRO+, the specialist brand



You're the expert in your field and at Renault PRO+ we're here to guide you through ours. We're passionate about delivering products and services to move your business forward. So when you choose to partner with Renault PRO+ you can expect:

Specialist network

Renault PRO+ Centres have a dedicated commercial vehicle specialist. So whatever you're seeking advice on, there's always someone to help.

Business Commitment

Come rain or shine, we have a set of commitments in place to help maximise uptime and minimise downtime.

The future today - 100% electric

Renault PRO+ has been building, selling and maintaining electric vans since 2011. So when you're looking to make the switch, you know who to speak to.

A tailored approach

Your vehicles are as unique as your business. That's why we have a programme of conversions to deliver exactly the product you want. From 'off the shelf' conversions to a more bespoke approach. We'll guide you through.

Renault services

3 Years Warranty

Your vehicle is covered by a warranty package for up to 3 years from date of first registration (unlimited mileage during the first 24 months, followed by a further 1 year limited to a total mileage of 100,000). Your Renault Dealer or Renault Z.E. Dealer is able to repair or replace without charge, parts that are found to have a material or assembly defect that is recognised by Renault. The paintwork warranty runs for 3 years and the anti-corrosion warranty for 12 years.

For Warranty Terms and Conditions please visit www.renault.co.uk/warranty.

3 Years Renault Assistance

Should you need it, we'll provide emergency roadside repairs or tow you to the nearest Renault Dealer or Renault ZE Dealer. This service is available 24 hours a day and is provided for 36 months from the date of first registration unlimited mileage for first 24 months, then limited to a total of 100,000 miles or 3 years, whichever comes first. Assistance is provided within the UK & Northern Ireland only at roadside, home and includes national recovery and onward travel. Assistance applies to mechanical or electrical defects which are covered by warranty.

For Renault Assistance and Renault Z.E. Assistance Terms and Conditions please visit www.renault.co.uk/assistance.

LCV Service Plans & Extended Warranties

Renault's LCV Service Plans are the ultimate package to provide care free servicing for your new Renault LCV.

It really is the hassle free way to take care of your Renault and benefits from;

- Inflation Proof Servicing - You know exactly what you'll pay and there are no hidden costs
- Peace of Mind - No matter where life takes you, we'll be there in over 5000 workshops across Europe
- Renault Expertise & Quality - Our highly trained technicians know your Renault inside out

The Renault LCV Service Plan contains Renault services in-line with the manufacturer's service schedule, plus comes with a complimentary vehicle safety check to ensure your Renault is in the best condition possible.

Renault LCV Extended Warranty enhancements also available. Refer to the Price Guide for more details.

Service Intervals

KANGOO Diesel Service: 2 years / 18,000 miles
KANGOO Z.E. Service: Year 1 / 12,000 miles, Year 2 / 24,000 miles and then every 2 years / 24,000 miles thereafter

Renault Network Services

No-one is better placed than Renault to maintain, fit and repair your Renault, fast. The Renault Minute (maintenance and repair with no appointment necessary) and Renault Rapide Bodycare (bumper scuffs, dings and dents, windscreen, stone chips and interior repairs...) services deliver the highest level of repair and maintenance and offer a full year's guarantee on Original Renault Parts. And don't forget to have a look at our wide range of additional equipment and accessories!

Renault iCare

Renault iCare is an innovative Service, Maintenance & Repair product that supplies Business customers with a fully supported, managed hassle free service and maintenance package.

Renault iCare is a "Pay-As-You-Go" product that insures your vehicle is maintained by Renault technical experts when work is required.

iCare provides the following benefits:

Full Service, Maintenance & Repair cover in the Renault Dealer Network

- Tyres can be included within the contract at an additional fixed cost
- Ancillary equipment can also be included (at an additional fixed monthly cost)
- Excludes: Damage/Neglect/Abuse/Glass & Bulbs

A fixed, pre agreed pence per mile rate

No excess mileage charges at the end of the contract

No pooled mileage administration

Minimalise downtime

For more information and to obtain a quote based on your requirements, please speak to your local Renault Business dealer or visit www.renault.co.uk/icare

Customer Relations

Renault knows the value of communicating with its customers and we have established effective ways to keep in touch with you. If, after speaking to your local Renault dealership, you are not completely satisfied, please contact the Renault UK Customer Relations Team on 0344 3350000† (Mon-Fri 8.00am to 6.00pm, Closed on Bank Holidays. Live Chat Mon-Fri 8.00am to 9.00pm). You can also visit our website www.renault.co.uk or write to us at: Renault UK Ltd, The Rivers Office Park, Denham Way, Maple Cross, Rickmansworth, Hertfordshire, WD3 9YS.

Finance options*

There are a wide variety of ways in which the purchase of a new vehicle can be financed. Renault Finance offers all of them, so whether you're a fleet buyer or private buyer, Renault Finance is ideally placed to tell you which plan or combination of plans best suits your needs and circumstances.



Continue the Renault KANGOO experience
at www.renault.co.uk/vans

Although every effort has been made to ensure that the information contained within this brochure is as accurate and up to date as possible, Renault U.K. reserves the right to modify its models without notice, including their characteristics, specifications, equipment and accessories. Brochures inevitably become out of date or inaccurate in some respects, in that such characteristics, specifications equipment, or accessories may be changed after the publication date given below and can differ from the descriptions given or the photos displayed. It is therefore necessary to check with your Renault Dealer before purchasing any product that the characteristics, specifications, equipment or accessories of the vehicle on order are as advertised. The colours that appear in this document may differ slightly from the actual paint and upholstery colours.

Renault recommends  Castrol

 Prodigious

Photo credits: © Renault Marketing 3D-Commerce, A. Bernier, R. Ritchter, S. Agnetti, O. Banet, D. Meunier – 7701 380 808 – April 2021