

every moment
is a chance to do.

SUBARU
LIBERTY
ALL-WHEEL DRIVE



2020



SUBARU



Find out more at www.subaru.com.au/liberty



you'll love every corner

There's nothing better than the moments you spend with family and friends. That's why a Subaru Liberty is designed to deliver an exceptional driving experience. With the legendary grip and control of Subaru's Symmetrical All-Wheel Drive (AWD) and horizontally-opposed Boxer engine at its core, a Subaru Liberty is a sedan that's not only beautiful to drive, it's a pleasure to own. Spacious and luxuriously appointed, you'll love every minute you're behind the wheel - your family and friends will too.

Liberty 3.6R AWD



Liberty 2.5i AWD

world-class engineering

Getting to work won't feel like work, with Subaru's much envied world-class engineering, superb handling and intuitive technology. Enjoy grip, supreme confidence and the benefit of an 'extra pair of eyes' on the road with Subaru's cutting-edge EyeSight® Driver Assist technology. Add Symmetrical All-Wheel Drive (AWD), rain-sensing windscreen wipers, LED Daytime Running Lights, a reverse camera and power-folding mirrors and you've got one smart sedan.

When you're behind the wheel of a Subaru Liberty 2.5i AWD, everything is easy. With a large LCD touchscreen, Apple CarPlay® and Android Auto™ connectivity¹, Digital radio² (DAB+), extra USB charging ports in the back and dual zone climate control to keep everyone happy.

Liberty 2.5i AWD features

Performance

- + Symmetrical All-Wheel Drive (AWD)
- + 2.5-litre horizontally-opposed Boxer petrol engine
- + Lineartronic® CVT with manual mode
- + Maximum power output: 129kW@5800rpm
- + Maximum torque: 235Nm@4000rpm
- + SI-Drive – 2 modes

Interior

- + 60/40 split folding rear seats
- + Air-conditioning – dual zone climate control
- + Cloth seat trim – black
- + Leather gear shift and steering wheel
- + Manual seat height lifter – driver
- + One touch lane change indicator
- + Sports pedals
- + USB charge port – rear passengers (x2)

Exterior

- + 18" alloy wheels
- + Daytime Running Lights – LED
- + Door mirrors with indicators – power-folding
- + Front fog lights – LED
- + Halogen headlights with auto off (dusk-sensing)
- + Rain-sensing windscreen wipers
- + Rear door and rear quarter privacy glass

Entertainment/Technology

- + Auto door lock/unlock
- + Auto Vehicle Hold (AVH)
- + Auxiliary jack and USB connection
- + Bluetooth®³ wireless technology
- + EyeSight® Driver Assist system featuring:
 - + Adaptive Cruise Control
 - + Brake Light Recognition

- + Lane Departure Warning
- + Lane Keep Assist
- + Lane Sway Warning
- + Lead Vehicle Start Alert
- + Pre-Collision Brake Assist
- + Pre-Collision Braking System
- + Pre-Collision Steering Assist
- + Pre-Collision Throttle Management
- + Integrated infotainment system featuring:
 - + 6.5" LCD touchscreen
 - + Apple CarPlay® and Android Auto™ connectivity¹
 - + Digital radio² (DAB+)
 - + Siri®⁴ compatibility
- + Multi-Information Display unit (MID)
- + Rear view reverse camera

1. Compatible Apple® or Android™ device required. 2. Digital radio station coverage dependent on vehicle location. 3. Bluetooth® is a registered trademark of Bluetooth SIG Inc. System functionality is subject to the Bluetooth® wireless technology specification of individual device. 4. Requires compatible Siri® enabled Apple® device to be paired with the infotainment system.

premium technology

The luxurious Subaru Liberty 2.5i Premium AWD boasts satellite navigation, an electric sunroof and Steering Responsive Headlights (SRH). Plus a larger 8" LCD touchscreen, heated driver and front passenger leather¹ seats and loads of safety features. Also built-in is Subaru's advanced Vision Assist system. Clever technology that gives you greater awareness of the world around you. Sensors can let you know when there's something in your blind spots, and Rear Cross Traffic Alert (RCTA) can warn you when reversing from a parking spot that another car is approaching.

Liberty 2.5i Premium AWD features

Performance

- + Symmetrical All-Wheel Drive (AWD)
2.5-litre horizontally-opposed Boxer petrol engine
- + Lineartronic[®] CVT with manual mode
- + Maximum power output: 129kW@5800rpm
- + Maximum torque: 235Nm@4000rpm
- + SI-Drive – 2 modes

Interior

- + 8-way power seats – driver and front passenger (driver with dual memory)
- + Air-conditioning – dual zone climate control
- + Auto-dimming rear view mirror
- + Electric lumbar support – driver
- + Heated front seats
- + Leather gear shift and steering wheel
- + Leather¹ seat trim – choice of black or ivory
- + One touch lane change indicator
- + Smart key and push-start ignition
- + Sports pedals
- + USB charge port – rear passengers (x2)

Exterior

- + 18" alloy wheels
- + Daytime Running Lights – LED
- + Door mirrors with indicators – heated and power-folding
- + Electric sunroof
- + Front fog lights – LED
- + Rain-sensing windscreen wipers
- + Rear door and rear quarter privacy glass
- + Self-levelling LED headlights with auto off (dusk-sensing)
- + Steering Responsive Headlights (SRH)

Entertainment/Technology

- + Auto Vehicle Hold (AVH)
- + Auxiliary jack and USB connections (x2)
- + Bluetooth^{®2} wireless technology
- + EyeSight[®] Driver Assist system featuring:
 - + Adaptive Cruise Control
 - + Brake Light Recognition
 - + Lane Departure Warning
 - + Lane Keep Assist

- + Lane Sway Warning
- + Lead Vehicle Start Alert
- + Pre-Collision Brake Assist
- + Pre-Collision Braking System
- + Pre-Collision Steering Assist
- + Pre-Collision Throttle Management
- + Integrated infotainment system featuring:
 - + 8" LCD touchscreen
 - + Apple CarPlay[®] and Android Auto[™] connectivity³
 - + Digital radio⁴ (DAB+)
 - + Satellite navigation
 - + Siri^{®5} compatibility
- + Multi-Information Display unit (MID)
- + Rear view reverse camera
- + Subaru's Vision Assist featuring:
 - + Adaptive Driving Beam (ADB)
 - + Blind Spot Monitor (BSM)
 - + Front View Monitor (FVM)
 - + Lane Change Assist (LCA)
 - + Rear Cross Traffic Alert (RCTA)
 - + Side View Monitor (SVM)

Premium technology.

Explore the range at www.subaru.com.au/liberty

1. Some parts of the seating or trim are not full natural leather. 2. Bluetooth[®] is a registered trademark of Bluetooth SIG Inc. System functionality is subject to the Bluetooth[®] wireless technology specification of individual device. 3. Compatible Apple[®] or Android[™] device required. 4. Digital radio station coverage dependent on vehicle location. 5. Requires compatible Siri[®] enabled Apple[®] device to be paired with the infotainment system.



Liberty 2.5i Premium AWD



Liberty 3.6R AWD

performance enhanced

For more power, luxury and performance step up to the Subaru Liberty 3.6R AWD. With 11 Harman Kardon® speakers¹, subwoofer and amplifier you won't feel like you're watching a band, you'll feel like you're in one. Under the hood is a six-cylinder horizontally-opposed Boxer engine that lies flat and therefore has a lower centre of gravity. Meaning better ride and superior handling. You'll love every centimetre of the Subaru Liberty 3.6R AWD. And every corner too.

Liberty 3.6R AWD features

Performance

- + Symmetrical All-Wheel Drive (AWD)
- + 3.6-litre horizontally-opposed Boxer petrol engine
- + Lineartronic® CVT with manual mode
- + Maximum power output: 191kW@6000rpm
- + Maximum torque: 350Nm@4400rpm
- + SI Drive – 3 modes

Interior

- + 8-way power seats – driver and front passenger (driver with dual memory)
- + Air-conditioning – dual zone climate control
- + Auto-dimming rear view mirror
- + Electric lumbar support – driver
- + Heated front seats
- + Leather gear shift and steering wheel
- + Leather² seat trim – choice of black or ivory
- + One touch lane change indicator
- + Smart key and push-start ignition
- + Sports pedals
- + USB charge port – rear passengers (x2)

Exterior

- + 18" alloy wheels
- + Daytime Running Lights – LED
- + Door mirrors with indicators – heated and power-folding
- + Dual tail pipes
- + Electric sunroof
- + Front fog lights – LED
- + Rain-sensing windscreen wipers
- + Rear door and rear quarter privacy glass
- + Self-levelling LED headlights with auto off (dusk-sensing)

Entertainment/Technology

- + 11 Harman Kardon®¹ speakers with subwoofer and amplifier
- + Auto Vehicle Hold (AVH)
- + Auxiliary jack and USB connections (x2)
- + Bluetooth®³ wireless technology
- + EyeSight® Driver Assist system featuring:
 - + Adaptive Cruise Control
 - + Brake Light Recognition
 - + Lane Departure Warning

- + Lane Keep Assist
- + Lane Sway Warning
- + Lead Vehicle Start Alert
- + Pre-Collision Brake Assist
- + Pre-Collision Braking System
- + Pre-Collision Steering Assist
- + Pre-Collision Throttle Management
- + Integrated infotainment system featuring:
 - + 8" LCD touchscreen
 - + Apple CarPlay® and Android Auto™ connectivity⁴
 - + Digital radio⁵ (DAB+)
 - + Satellite navigation
 - + Siri®⁶ compatibility
- + Multi-Information Display unit (MID)
- + Rear view reverse camera
- + Subaru's Vision Assist featuring:
 - + Adaptive Driving Beam (ADB)
 - + Blind Spot Monitor (BSM)
 - + Front View Monitor (FVM)
 - + Lane Change Assist (LCA)
 - + Rear Cross Traffic Alert (RCTA)
 - + Side View Monitor (SVM)

1. Harman Kardon® is a registered trademark of HARMAN International Industries, Incorporated. 2. Some parts of the seating or trim are not full natural leather. 3. Bluetooth® is a registered trademark of Bluetooth SIG Inc. System functionality is subject to the Bluetooth® wireless technology specification of individual device. 4. Compatible Apple® or Android™ device required. 5. Digital radio station coverage dependent on vehicle location. 6. Requires compatible Siri® enabled Apple® device to be paired with the infotainment system.

feel good inside

The Subaru Liberty is luxurious and smart. With soft touch finishes and leather¹ seats on premium variants, both you and your passengers will feel comfortable the moment they step inside. And with a large LCD touchscreen, Apple CarPlay[®] and Android Auto[™] connectivity², Digital radio³ (DAB+) and extra charging USB ports, be immersed in your music.



Infotainment system

Liberty 2.5i Premium AWD and 3.6R AWD



USB connectivity

Liberty 2.5i Premium AWD and 3.6R AWD



Harman Kardon^{®4} speakers

Liberty 3.6R AWD



Push-start ignition

Liberty 2.5i Premium AWD and 3.6R AWD



1. Some parts of the seating or trim are not full natural leather.
2. Compatible Apple[®] or Android[™] device required. 3. Digital radio station coverage dependent on vehicle location. 4. Harman Kardon[®] is a registered trademark of HARMAN International Industries, Incorporated.



**Liberty 2.5i
Premium AWD**

look beautiful outside

Interior

Black cloth is standard on Liberty 2.5i AWD. Beautiful leather¹ is available on premium variants in a choice of black or ivory.



Leather¹
Black



Leather¹
Ivory



Cloth
Black

Exterior

With a wide range of sophisticated colours to choose from, it's easy to pick a new Subaru Liberty that suits you. It's also nice to know that Subaru does not charge extra for Metallic Paint.

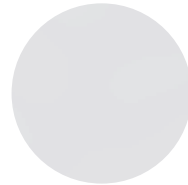

Crystal White
Pearl

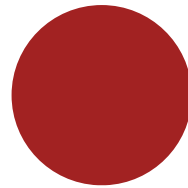

Crimson Red
Pearl

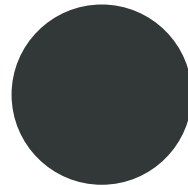

Magnetite Grey
Metallic

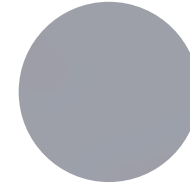

Ice Silver
Metallic

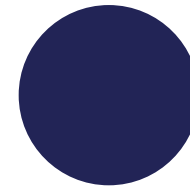

Dark Blue
Pearl

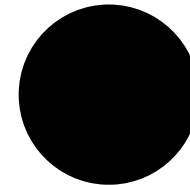

Crystal Black
Silica

1. Some parts of the seating or trim are not full natural leather.

Note: Paint colours are representative only and subject to variation due to the printing process.

why Liberty?

Symmetrical force of power

Our All-Wheel Drive philosophy

Greater balance and control. That's the confidence you get from our unique Symmetrical All-Wheel Drive (AWD) system, which delivers the drive distribution to all four wheels, all the time. Every Subaru Liberty has an innate sense of balance from the ground up, thanks to a near perfect symmetrical layout.

Boxing clever

Our famous Subaru Boxer engine

While most engines stand vertically, ours lay flat. The famous Subaru Boxer engine helps to deliver better handling. Sitting horizontally in the engine bay, it moves like a boxer's fists with a punch and counterpunch action. Lightweight, low and flat, it makes for near perfect balance and a much lower centre of gravity. It creates less noise and vibration too. All of this means better on-road handling for you. More stability. More performance. More fun. And a more confident drive.

Finest safety

5 star ANCAP safety across the Liberty range

With spirit, quality and imagination comes some serious safety innovation. We want every Subaru Liberty to be amongst the safest cars on the road. Engineered full of cutting-edge technologies and the most intelligent design features. The Subaru Liberty carries the maximum 5 star ANCAP¹ safety rating.

Eyes in the back of your head

Rear view reverse camera

Manoeuvring back into a tight side street? Family driveway littered with toys? Reverse with confidence, thanks to our rear view reverse camera technology. The rear view reverse camera is like having eyes in the back of your head. This greatly improves your visibility and reduces the risk of bumps and scrapes. A rear view reverse camera is standard on every Subaru Liberty variant.

Efficiency without compromise

Auto Stop Start

We're constantly thinking of ways to help the environment and become more fuel-efficient. That's why we developed Auto Stop Start technology. It saves fuel by immediately cutting the engine when you don't need it, like when you're idling or stopped in heavy traffic. The moment you're ready to move again, the engine restarts in a fraction of a second. Our Auto Stop Start technology is standard on Liberty 2.5i AWD and 2.5i Premium AWD variants.

1. The Australasian New Car Assessment Program (ANCAP) gives consumers consistent information on the level of occupant protection provided by vehicles in serious front and side crashes.

Yet another world first

Lineartronic® CVT

Pushing innovation beyond the bounds, we introduced an automatic transmission called Lineartronic® Continuously Variable Transmission (CVT). And it's the reason our automatic models drive so smooth. It's the world's first longitudinally mounted system for AWD vehicles. Unlike a conventional automatic transmission – which uses fixed gear ratios – our Lineartronic® CVT provides infinite variability between the highest and lowest available gears. So you now experience a smooth gear change, into any optimum gear for that moment. Lineartronic® CVT is standard on all Subaru Liberty variants.

Intelligently driven

Subaru Intelligent Drive

Heading to the shops? Taking on the Great Ocean Road? Each situation deserves a distinctive driving mode, so we crafted

Subaru Intelligent Drive (SI-Drive) technology, available on all Subaru Liberty variants, to do just that. Switch from smart, to sporty to even sportier. Intelligent (I) mode – perfect for everyday driving, Sport (S) mode – for enhanced acceleration and all-round sporty performance and on the Subaru Liberty 3.6R AWD, Sport Sharp (S#) mode – for a truly thrilling drive.

We're looking out for you

EyeSight® Driver Assist

We were the first car company to exclusively use stereo camera technology to detect objects in our vehicles path. A sign of our future-thinking and our commitment to quality, technology and safety, EyeSight® Driver Assist is like your second pair of eyes, spotting potentially dangerous situations. If EyeSight® detects anything that might be of danger, it warns you audibly, urging you to take action and brake. EyeSight® Driver Assist technology is standard across the entire Subaru Liberty range.

Clever thinking

Subaru's Vision Assist

Subaru's Vision Assist is advanced technology that gives you greater awareness of the world around you. Subaru's Vision Assist Blind Spot Monitoring features rear and side sensors that let you know when there's something in a blind spot to make lane changes safer. The Rear Cross Traffic Alert can warn you that another car is approaching when reversing out of a car space. Cutting-edge technology to help keep your family safe. Subaru's Vision Assist available on Subaru Liberty 2.5i Premium AWD and 3.6R AWD.

Subaru Liberty specifications¹

MODEL		2.5i AWD	2.5i Premium AWD	3.6R AWD
Model Variant		Sedan	Sedan	Sedan
Transmission				
Lineartronic® CVT with manual mode		•	•	•
Engine				
Engine type		Horizontally-opposed Boxer 4-cylinder, petrol engine		Horizontally-opposed Boxer 6-cylinder, petrol engine
Valve mechanism		DOHC 16-valve		DOHC 24-valve
Bore x stroke	mm	94.0 x 90.0		92.0 x 91.0
Capacity	cc	2498		3630
Compression ratio		10.3:1		10.5:1
Fuel tank capacity	litres	60		
Fuel system		Multi point sequential injection		
Fuel requirement (min)	RON	91		
Performance²				
Maximum power output (DIN)	kW/rpm	129kW@5800rpm		191kW@6000rpm
Maximum torque (DIN)	Nm/rpm	235Nm@4000rpm		350Nm@4400rpm
Acceleration 0 – 100 km/h	seconds	9.6		7.2
Electronic Throttle Control system (ETC)		Drive-by-wire		
Fuel consumption (ADR 81/02) For comparison purposes only. Real world results may vary ³ :				
	combined	l/100km	7.3	9.9
	urban	l/100km	9.1	14.2
	extra urban	l/100km	6.2	7.5
CO ₂ emissions (ADR81/02)	combined	(g/km)	166	230

1. Subaru Australia reserves the right to change mechanical specification and equipment levels without notice. 2. All performance data measured using 95RON test fuel as required by Australian Design Rule 81/02. Vehicles tested in accordance with ADR 81/02. 3. Fuel consumption figures quoted are measured in accordance with Australian Design Rule 81/02 and are for comparison purposes only. Real world results may vary based on individual driving circumstances e.g. traffic conditions, driving style, vehicle modifications, fuel quality, climatic conditions etc. Quoted figures may not reflect real world fuel consumption.

Subaru Liberty specifications¹

MODEL		2.5i AWD	2.5i Premium AWD	3.6R AWD
Symmetrical All-Wheel Drive (AWD)				
Type	Auto	Active Torque Split		
Transmission				
Gear ratio	1st	3.600		3.105
	2nd	2.080		1.983
	3rd	1.596		1.454
	4th	1.221		1.057
	5th	0.939		0.779
	6th	0.717		0.542
	7th	0.512		N/A
Gear ratio – reverse		3.687		3.021
Final reduction gear ratio		3.900		4.111
Steering				
Type		Electric power-assisted rack-and-pinion		
Minimum turning circle	m	11.2		
Suspension				
Type	Front	MacPherson struts, lower L-arms, coil springs, stabiliser bar		
	Rear	Double wishbone, coil springs, stabiliser bar		
Brakes				
Type	Front	Ventilated disc brake		
	Rear	Ventilated disc brake		
Brake booster type		Tandem		
ABS		4-channel, 4-sensor ABS with Electronic Brakeforce Distribution		

1. Subaru Australia reserves the right to change mechanical specification and equipment levels without notice.

Subaru Liberty specifications¹

MODEL		2.5i AWD	2.5i Premium AWD	3.6R AWD
Wheels and Tyres				
Tyre manufacturer		Dunlop		
Tyres (width, profile, size, load index and speed rating)		225/50 R18 95W		
Rim size		18x7 1/2J		
Wheels		18"		
Spare wheel		18"		
Measurement				
Overall length	mm	4800		
Overall width	mm	1840		
Overall height	mm	1500		
Wheel base	mm	2750		
Front track	mm	1580		
Rear track	mm	1595		
Minimum ground clearance ²	mm	150		
Cargo volume – rear seat up/down	litres	493		
Seating capacity		5		
Tare mass ³	kg	1512	1537	1619
Towing				
With trailer brakes (max)	kg	1500		1800
Without trailer brakes (max)	kg	750		750
Maximum tow ball down load	kg	150		180

1. Subaru Australia reserves the right to change mechanical specification and equipment levels without notice. 2. Ground clearance at kerb weight. 3. Vehicle tare mass varies according to the types of optional equipment included.

Subaru Liberty features¹

MODEL	2.5i AWD	2.5i Premium AWD	3.6R AWD
Transmission			
Lineartronic® CVT with manual mode	•	•	•
Safety Rating			
5 star ANCAP ² safety rating (maximum 5)	•	•	•
Collision Avoidance			
Symmetrical All-Wheel Drive (AWD)	•	•	•
4-wheel disc brakes	•	•	•
Auto Vehicle Hold (AVH)	•	•	•
Electronic parking brake	•	•	•
Rear view reverse camera	•	•	•
Vehicle Dynamics Control system (VDC) featuring:	•	•	•
Active Torque Vectoring system	•	•	•
Anti-lock Braking System (ABS)	•	•	•
Brake Assist	•	•	•
Electronic Brakeforce Distribution (EBD)	•	•	•
Electronic Stability Control (ESC)	•	•	•
Traction Control System (TCS)	•	•	•
Subaru's Vision Assist featuring:		•	•
Adaptive Driving Beam (ADB)		•	•
Blind Spot Monitor (BSM)		•	•
Front View Monitor (FVM)		•	•
Lane Change Assist (LCA)		•	•
Rear Cross Traffic Alert (RCTA)		•	•
Side View Monitor (SVM)		•	•
Collision Protection			
3 point A/ELR rear seat belts	•	•	•
Front seat belts with pretensioners and load limiters	•	•	•
Height-adjustable rear seat headrests	•	•	•
Height-adjustable seat belt anchors – driver and front passenger	•	•	•
Height and angle-adjustable front seat headrests	•	•	•

1. Subaru Australia reserves the right to change mechanical specification and equipment levels without notice. 2. The Australasian New Car Assessment Program (ANCAP) gives consumers consistent information on the level of occupant protection provided by vehicles in serious front and side crashes.

Subaru Liberty features¹

MODEL	2.5i AWD	2.5i Premium AWD	3.6R AWD
Rear seat headrests for 3 seating positions	•	•	•
Ring-shaped passenger safety cell	•	•	•
Seat belt warning lights – all seats	•	•	•
SRS ² airbags – dual front, dual front side and curtain	•	•	•
SRS ² airbags – knee airbag (driver)	•	•	•
Child Safety			
Child seat anchor points (x3)	•	•	•
ISOFIX child seat anchor points (x2)	•	•	•
Rear door child locks	•	•	•
Intelligent Driving Dynamics			
Auto Stop Start	•	•	
Electronic Throttle Control system (ETC)	•	•	•
EyeSight [®] Driver Assist system featuring:	•	•	•
Adaptive Cruise Control	•	•	•
Brake Light Recognition	•	•	•
Lane Departure Warning	•	•	•
Lane Keep Assist	•	•	•
Lane Sway Warning	•	•	•
Lead Vehicle Start Alert	•	•	•
Pre-Collision Brake Assist	•	•	•
Pre-Collision Braking System	•	•	•
Pre-Collision Steering Assist	•	•	•
Pre-Collision Throttle Management	•	•	•
Subaru Intelligent Drive (SI-Drive)	2 modes	2 modes	3 modes
Exterior			
18" alloy wheels	•	•	•
Body coloured door handles	•	•	•
Body coloured rear garnish	•	•	Chrome type
Bonnet with gas struts	•	•	•
Chrome type inserts on door handles			•
Chrome type side skirt garnish			•
Chrome type window sills	•	•	•
Detachable module type windscreen wipers	•	•	•

1. Subaru Australia reserves the right to change mechanical specification and equipment levels without notice. 2. SRS: Supplemental Restraint System. Effective when used in conjunction with seat belts.

Subaru Liberty features¹

MODEL	2.5i AWD	2.5i Premium AWD	3.6R AWD
Door mirrors:			
Body coloured	•	•	•
Heated		•	•
Indicators	•	•	•
Power-folding	•	•	•
Dual tail pipes			•
Electric sunroof		•	•
Engine cover			•
Front wipers with de-icer	•	•	•
Full size spare wheel	•	•	•
Rear door and rear quarter privacy glass	•	•	•
Side sill skirts	•	•	•
Tail pipe covers	•	•	•
Lighting – Exterior			
Daytime Running Lights – LED	•	•	•
Front fog lights – LED	•	•	•
Headlights – dusk-sensing	•	•	•
Headlights – halogen with auto off	•		
Headlights – self-levelling LED with auto off		•	•
Rear LED stoplight	•	•	•
Steering Responsive Headlights (SRH)		•	•
Welcome lighting	•	•	•
Lighting – Interior			
Cabin and cargo area lights	•	•	•
Illuminated ignition ring	•		
Map lights (x2)	•	•	•
Air-conditioning			
Anti-dust filter	•	•	•
Dual zone climate control	•	•	•
Floor heater ducts for rear passengers	•	•	•
Front and side demisters	•	•	•
Rear windscreen demister – electric	•	•	•

1. Subaru Australia reserves the right to change mechanical specification and equipment levels without notice.

Subaru Liberty features¹

MODEL	2.5i AWD	2.5i Premium AWD	3.6R AWD
Security			
Immobiliser security system	•	•	•
Instrumentation and Controls			
Adjustable steering wheel – height and telescopic	•	•	•
Customisable gauge colours	•	•	•
Electroluminescent gauges with colour MID	•	•	•
Instrument cluster	•	•	•
Manual mode	•	•	•
One touch lane change indicator	•	•	•
Paddle gear shifters	•	•	•
Sports pedals	•	•	•
Steering wheel controls:	•	•	•
Audio	•	•	•
Bluetooth® ²	•	•	•
EyeSight®	•	•	•
MID	•	•	•
SI-Drive	•	•	•
Twin trip meter (switchable)	•	•	•
Multi-Function Displays			
Multi-Information Display unit (MID) featuring:	•	•	•
5" LCD screen	•	•	•
Audio display	•	•	•
Auto Stop Start information	•	•	•
Bluetooth® ² phone display	•	•	•
Digital speedometer	•	•	•
Eco-gauge display	•	•	•
EyeSight® display	•	•	•
Fuel economy and journey information	•	•	•
Outside temperature and clock display	•	•	•
SI-Drive display	•	•	•
Warning display	•	•	•

1. Subaru Australia reserves the right to change mechanical specification and equipment levels without notice. 2. Bluetooth® is a registered trademark of Bluetooth SIG Inc. System functionality is subject to the Bluetooth® wireless technology specification of individual device.

Subaru Liberty features¹

MODEL	2.5i AWD	2.5i Premium AWD	3.6R AWD
Storage			
Cargo hooks	•	•	•
Centre console box	•	•	•
Cupholders – rear and centre console	•	•	•
Door pockets with integrated bottle holder – front and rear	•	•	•
In-dash console box	•	•	•
Overhead console – sunglass holder	•	•	•
Seat back pocket – driver and front passenger side	•	•	•
Convenience			
12V/120W power jacks (x2)	•	•	•
Auto-dimming rear view mirror		•	•
Auto door lock/unlock	•	•	•
Boot/tailgate unlock on remote central locking keys	•	•	•
Interior fuel lid lock release	•	•	•
Intermittent variable speed front windscreen wipers	•	•	•
Power steering, mirrors and windows	•	•	•
Rain-sensing front windscreen wipers	•	•	•
Rear seat centre armrest	•	Black with chrome type	Black with chrome type
Remote central locking (keys x2)	•	•	•
Smart key and push-start ignition		•	•
Sunvisors with illuminated vanity mirrors – driver and front passenger	•	•	•
USB charge port – rear passengers (x2)	•	•	•
Interior Trims			
Carpet trim – black	•	•	•
Gear shift surround – gloss black	•	•	•
Leather steering wheel and gear shift	•	•	•
Seat trim – black cloth	•		
Seat trim – black or ivory leather ²		•	•
Side sill plates (front) – stainless	•	•	•

1. Subaru Australia reserves the right to change mechanical specification and equipment levels without notice. 2. Some parts of the seating or trim are not full natural leather.

Subaru Liberty features¹

MODEL	2.5i AWD	2.5i Premium AWD	3.6R AWD
Seating Extras			
60/40 split folding rear seats	•	•	•
8-way power seat – front passenger		•	•
8-way power seat with dual memory – driver		•	•
Electric lumbar support – driver		•	•
Heated seats – driver and front passenger		•	•
Manual seat height lifter – driver	•		
Entertainment			
Auxiliary jack – front centre console	•	•	•
Bluetooth ^{®2} wireless technology with:	•	•	•
Audio streaming ³	•	•	•
Handsfree mobile communication	•	•	•
Integrated infotainment system featuring:	•	•	•
6 speakers	•	•	
6.5" LCD touchscreen	•		
8" LCD touchscreen		•	•
11 Harman Kardon ^{®4} speakers, subwoofer and amplifier			•
AM/FM radio	•	•	•
Apple CarPlay [®] and Android Auto [™] connectivity ⁵	•	•	•
Digital Radio ⁶ (DAB+)	•	•	•
Satellite navigation		•	•
Single CD player	•	•	•
Siri ^{®7} compatibility	•	•	•
USB connection – front centre console	(x1)	(x2)	(x2)
Voice command recognition	•	•	•
Owner Benefits			
5 Year/Unlimited Km Warranty ⁸	•	•	•
5 Year/125,000 Km Capped Price Servicing Program ⁹	•	•	•
12 Month Roadside Assistance Program ¹⁰	•	•	•

1. Subaru Australia reserves the right to change mechanical specification and equipment levels without notice. 2. Bluetooth[®] is a registered trademark of Bluetooth SIG Inc. System functionality is subject to the Bluetooth[®] wireless technology specification of individual device. 3. There may be restrictions on features available for certain variants that are not fully compliant with the AVCRP. 4. Harman Kardon[®] is a registered trademark of HARMAN International Industries, Incorporated. 5. Compatible Apple[®] or Android[™] device required. 6. Digital radio station coverage dependent on vehicle location. 7. Requires compatible Siri[®] enabled Apple[®] device to be paired with the infotainment system. 8. Every new Subaru comes with a 5 Year/Unlimited Km warranty period, unless the vehicle is used as a hire car, taxi, ride share, rental, driving school, delivery or courier vehicle in which case the warranty period is 5 Year/150,000 Km (whichever occurs first). For full warranty terms and conditions, visit www.subaru.com.au/warranty. 9. Every eligible Model Year 2020 onward Subaru Liberty comes with Subaru's 5 Year/125,000 Km Capped Price Servicing Program. Available at participating Subaru Retailers only and does not apply to rental and some other classes of vehicles. For full Capped Price Servicing Terms and Conditions, visit www.subaru.com.au/service/pricing/capped-price-servicing. 10. 12 Month Roadside Assistance Program is standard upon activation with relevant Motoring Club in each state. To receive this benefit the customer must opt into the 12 Month Roadside Assistance program at time of vehicle delivery. Eligible customers are those retail and novated lease customers who purchase a new Subaru on or after 1st June 2013 and have less than 5 vehicles under the Club Membership offer. Customers must provide a valid phone and residential address, as well as date of birth. Fleet, Government and Rental companies are excluded.



Liberty 3.6R AWD

make it yours

Customise your Subaru Liberty to help you make the most of every moment you spend with family and friends. From the working week to weekends, we've got you covered with a range of Genuine Subaru Accessories to make your Subaru perfect for you.

- + Styling Bring out your distinctive Subaru Liberty style with a range of stylish exterior options.
- + Protection Protect your Subaru Liberty with a range of products including carpet mat sets, a cargo tray and a rear bumper protector.
- + Cargo To extend your Subaru Liberty's carrying capacity we offer a broad range of Subaru and Thule sport and cargo carrier accessories.
- + Security, Convenience and Safety Keep your new wheels secure with a set of wheel lock nuts. To help take the stress away with parking in tight spaces we offer front corner and reverse parking sensors.
- + STI Performance Parts Tweak the handling of your Subaru Liberty for that extra edge. Bring out the best with STI Performance Parts for optimum handling and control.

Genuine Subaru Accessories are available from your Subaru Retailer, so be sure to ask about the range when buying your new Subaru Liberty.

 To view our complete range of accessories and pricing online visit www.subaru.com.au/liberty/accessories



packs that will inspire you

These quality Subaru Accessory packs will give you the protection you need and versatility you desire to do more in your Subaru Liberty. Plus you'll have the reassurance that Genuine Subaru Accessories are protected by our manufacturer's warranty¹.

Protection Pack includes:

a Mud Guards (Front and Rear)

Help protect the sides of your Liberty from nasty stone chips with tailor-made mud guards.

b Carpet Mat Set

Enjoy the comfort with a luxurious Subaru branded quality carpet mat set.

c Cargo Tray

Throw all the gear in the back with a heavy duty mat to protect the cargo area from dust and dirt.

d Weather Shields

Sleekly designed with integrated chrome style mouldings that are tailored to fit onto each door individually.

Explorer Pack includes:

Add a Tow Bar to the Protection Pack to squeeze more out of your everyday.

e Tow Bar

Hook your toys up to a functional and sturdy tow bar engineered specifically for the Australian market.



1. For full warranty terms and conditions, visit www.subaru.com.au/accessories-information/warranty

protect your investment

Get out and do more while protecting your Subaru Liberty from the rough and tumble of daily life. From carpet mats to mud guards, each of the below accessories are tailored for a perfect fit.

ACCESSORY	Part Number	2.5i AWD	2.5i Premium AWD	3.6R AWD
Styling				
1 Front Grille	J1010AL310		•	•
2 Front Grille (with camera cover)	J1010AL310K	•		
3 Alloy Wheel Set 18" – Red	B3110VA500K	•	•	•
4 Alloy Wheel Set 18" – Blue	B3110VA600K	•	•	•
Protection				
5 Headlamp Protectors	J101AAL010		•	•
6 Weather Shields	F0010AL700	•	•	•
7 Mud Guards (Front) ¹	J1010AL001NN	•	•	
8 Mud Guards (Rear)	J1010AL024NN	•	•	•
9 Rear Seat Pet Protector	F4110SG000	•	•	•
10 Carpet Mat Set	J5010AL000	•	•	•
11 Rubber Mat Set	J5010AL100	•	•	•
12 Body Side Moulding	J1010AL600##	•	•	•
13 Body Side Moulding (Non-painted)	J1010AL600NN	•	•	•
14 Liberty Protection Film	SAT2017	•	•	•
15 Bootlip and Bumper Protector	SAT6003	•	•	•

1. Mud Guards (Front) also available for Liberty 3.6R AWD – Part Number J1010AL101NN.

Denotes colour option of your choice. Not all colour options may be available. Please check with your Subaru Retailer for availability.

 To view our complete range of accessories and pricing online visit www.subaru.com.au/liberty/accessories

	Not Applicable
•	Applicable

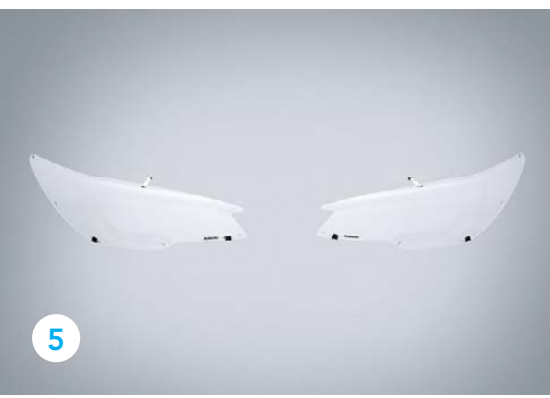

16



17



18



19



20



21



22



23



24



25

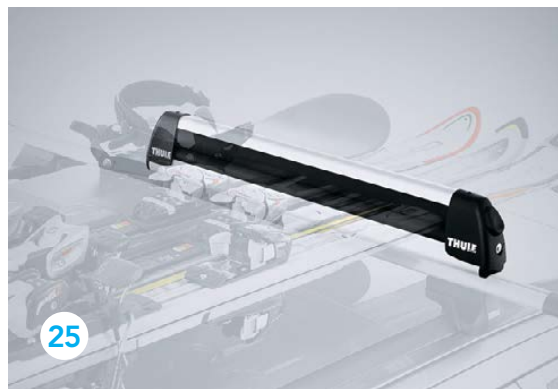

26



27



28



29



do all the things you've planned

Tow it, stow it or just pack more into your every day with our range of Subaru Liberty compatible cargo options, plus premium Thule sport and cargo carrier accessories.

ACCESSORY	Part Number	2.5i AWD	2.5i Premium AWD	3.6R AWD
Cargo and Tow				
16 Tow Bar	L101AAL012	•	•	•
17 Cargo Tray	J501AAL100	•	•	•
18 Roof Cross Bars	SAT3011	•	•	•
Thule Roof Attachments and Accessories				
19 Xtender 6 Pair Ski Holder	SA1156	•	•	•
20 Deluxe Ski Carrier – 4 Pair	SAT8023	•	•	•
21 Deluxe Ski Carrier – 6 Pair	SAT8024	•	•	•
22 Bicycle Holder – Silver (Upright)	SAT8018	•	•	•
23 Bicycle Holder – Black (Upright)	SAT8019	•	•	•
24 Bicycle Holder (Fork Mounted)	SA1042	•	•	•
25 Ski Holder – 4 Pair	SAT9012	•	•	•
26 Ski Holder – 6 Pair	SAT9013	•	•	•
27 Surfboard Carrier	SA1139	•	•	•
28 Kayak Carrier – Dockglide	SAT9018	•	•	•
29 Thule Paddleboard & Mal Carrier	SAT8016	•	•	•

 To view our complete range of accessories and pricing online visit www.subaru.com.au/liberty/accessories

ACCESSORY		Part Number	2.5i AWD	2.5i Premium AWD	3.6R AWD
Thule Roof Attachments and Accessories					
30	Roof Box – Thule Force XT M (Matte Black)	SAT5013	•	•	•
31	Roof Box – Thule Force XT L (Matte Black)	SAT5014	•	•	•
32	Roof Box – Thule Force XT XL (Matte Black)	SAT5015	•	•	•
33	Thule GoPack Set (4 bags for Roof Box)	SAT8030	•	•	•
34	Side Up Wheel Step	SAT9004	•	•	•
Tow Bar Attachments (Tow Bar required)					
35	Thule Tow Bar Mounted Bike Carrier (Two Bikes)	SAP925	•	•	•
36	Thule Tow Bar Mounted Bike Carrier (Three Bikes)	SAP927	•	•	•
Security					
37	Wheel Lock Nuts	B327EYA000	•	•	•
Convenience and Safety					
38	Reverse Sensors	H481AAL400##	•	•	•
39	Front Corner Parking Sensors	H481AAL300##	•	•	•
40	Cigarette Lighter	H6710AL010	•	•	•
41	Round Type Ash Tray (Black)	92172AG040	•	•	•

Denotes colour option of your choice.

 To view our complete range of accessories and pricing online visit www.subaru.com.au/liberty/accessories



30



31



32



33



34



35



36



37



38



39

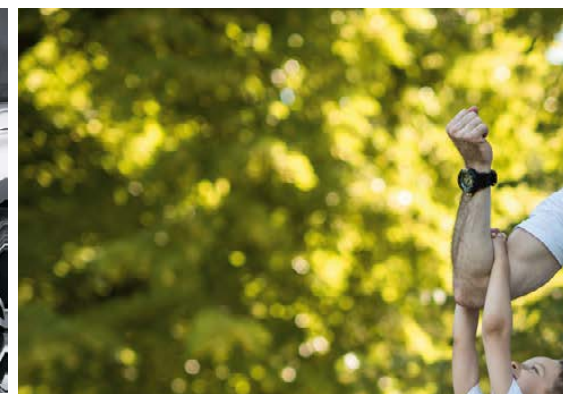

40



41



42



43



44



45



46



47



48



49



50



51



52



53



kick it into overdrive

Show your allegiance with bold, branded accessories to protect and style your new Subaru Liberty.

ACCESSORY	Part Number	2.5i AWD	2.5i Premium AWD	3.6R AWD
Convenience and Safety				
42 First Aid Kit	SM7001	•	•	•
43 Safety Triangle	SAT9007	•	•	•
44 Garmin Dash Cam 56 ¹	0100223111	•	•	•
45 Garmin Dash Cam Mini ¹	0100206210	•	•	•
STI Performance Parts				
46 Front Under Spoiler	ST96020BB050A	•	•	•
47 STI Shift Knob CVT	C1010AL000	•	•	•
48 STI Flexible Tower Bar	E4010AL000	•	•	•
49 STI ENKEI Alloy Wheel Set (4) – 18 inch (Silver)	B3110AL031K	•	•	•
50 STI ENKEI Alloy Wheel Set (4) – 18 inch (Gun Metal)	B3110AL041K	•	•	•
51 STI ENKEI Alloy Wheel Set (4) – 18 inch (Black)	B3110AL051K	•	•	•
52 Security Wheel Nut Set	ST28170ST060	•	•	•
53 Valve Cap Set	ST28102ST030	•	•	•

1. Requires 8GB microSD™ card, Class-10 or faster (not included).



To view our complete range of accessories and pricing online visit
www.subaru.com.au/liberty/accessories

welcome to the family

There are cars that simply get you from A to B, and then there are cars that empower you. Buying a Subaru is like embracing life with both hands and knowing that nothing is going to stop you. When you buy a new Subaru you are welcomed into an owner's program that gives you access to a number of benefits.

Subaru New Car Warranty – 5 Year/Unlimited Kilometres¹

Every new Subaru purchased for private use is covered by a 5 Year/Unlimited Km manufacturer's national warranty. Visit www.subaru.com.au/warranty or ask your Subaru Retailer for more information.

Subaru Capped Price Servicing

With our 5 Year/125,000 Km Capped Price Servicing Program², you'll now know the maximum amount you will have to pay for your next scheduled service during the Program period. You'll also have peace of mind knowing that specialist Subaru technicians will be looking after your pride and joy using only Genuine Subaru Parts.



1-Month Health Check and Chat

The 1-Month Health Check and Chat is a free consultation within the first month after delivery of your new Subaru. It allows our factory-trained technicians to provide quick vehicle checks, and one of our Service Advisors will answer any of your questions to help ensure an ongoing, worry-free experience.

Subaru's Map Updates

If your new Subaru is fitted with a factory line fit navigation unit, your unit will be covered by Subaru's Map Update Program³ – guaranteeing you'll have access to the latest maps for the first 3 years of ownership.

Subaru Roadside Assistance

Enjoy 12 months of Australia-wide, standard Roadside Assistance when you purchase your new Subaru. In the unfortunate situation where you need that extra helping hand, our Roadside Assistance will help⁴ with arranging a tow, battery service, flat tyre service, fuel delivery and lockout service.

1. Every new Subaru comes with a 5 Year/Unlimited Km warranty period, unless the vehicle is used as a hire car, taxi, ride share, rental, driving school, delivery or courier vehicle in which case the warranty period is 5 Year/150,000 Km (whichever occurs first). For full warranty terms and conditions, visit www.subaru.com.au/warranty. 2. Every eligible Model Year 2020 onward Subaru Liberty comes with Subaru's 5 Year/125,000 Km Capped Price Servicing Program. Available at participating Subaru Retailers only and does not apply to rental and some other classes of vehicles. For full Capped Price Servicing Terms and Conditions visit www.subaru.com.au/service/pricing/capped-price-servicing. 3. Subaru's Map Update Program is available on MY20 Subaru Liberty models purchased from 10th February 2020 onwards with the factory line fit Gen3.1 navigation unit. Subaru's Map Update Program is not available on accessory fit or dealer sourced navigation units. For full terms and conditions of the Subaru Map Update Program visit www.subaru.com.au/owner-experience/benefits/subaru-map-update-program. 4. 12 month Club Membership and Roadside Assistance Offer is standard upon activation with the relevant Motoring Club in each state. To receive this benefit the customer must opt into the 12 month Club Membership and Roadside Assistance Offer at time of vehicle delivery. Eligible customers are those retail and novated lease customers who purchase a new Subaru and have less than 5 vehicles under the Club Membership offer. Customers must provide a valid phone number and residential address, as well as date of birth. Fleet, Government and Rental companies are excluded. Terms and conditions apply. For a full list of benefits, visit www.subaru.com.au/owner-experience/benefits/program/roadside.

live life without limits

Subaru Certified Collision Repairer Network

With a dedicated Subaru Certified Collision Repairer¹ helpline available on 1800 737 179, help is available when you need it most. Available 24-hours a day, 7 days a week, help is only a phone call away. Subaru Certified Collision Repairers guarantee that trained specialists will repair your Subaru to strict factory specifications using Genuine Subaru Parts.

Genuine Accessories

Genuine Subaru Accessories are designed to enhance your vehicle, help you get more stuff done and have more fun! Our genuine accessories are factory approved by

Subaru and are protected by the Genuine Subaru Accessories Warranty. For our full range of Subaru Liberty accessories visit www.subaru.com.au/liberty/accessories. For more information on Genuine Subaru Accessories, visit www.subaru.com.au/accessories-information.

Subaru Insurance

It's important to enjoy the freedom of owning a Subaru, but it's also important to protect it. A range of Subaru Insurance² options provides a variety of choices, including: Subaru Premier Motor Insurance and Subaru Extended Warranty Insurance.

Subaru Certified Used Cars

Every Subaru Certified Used Car has passed a 120-point quality inspection and comes with a one year unlimited kilometre Subaru Assured Warranty³ – to complement the balance of a new vehicle warranty or the statutory warranty that remains – from participating Subaru Certified Used Car Retailers.

1. Subaru Certified Collision Repairer network not available in all areas. Call 1800 737 179 or visit www.subaru.com.au/retailers to find your closest Subaru Certified Collision Repairer. 2. Subaru Insurance products are issued by Allianz Australia Insurance Limited AFS Licence No. 234 708 ABN 15 000 122 850 (Allianz). In arranging this insurance Subaru (Aust) Pty Limited ABN 95 000 312 792 (Subaru) and the authorised dealers act as agents of Allianz and not as your agent. Neither Subaru nor any of its related companies or appointed authorised retailers have any liability in respect of these policies. 3. The Subaru Assured Warranty product is issued by the selling Subaru Retailer. Subaru Australia has no liability in respect of this warranty.

Subaru Liberty Awards

- 2015 - Australasian New Car Assessment Program 5 star ANCAP safety rating
- 2009 - Australia's Best Cars, Prestige Car, Liberty 3.6R Premium
 - Australasian New Car Assessment Program 5 star ANCAP safety rating
- 2008 - International Engine of the Year Award, 2.0 - 2.5-litre class,
(2.5-litre turbocharged horizontally-opposed Boxer engine)
- 2006 - International Engine of the Year Award, 2.0 - 2.5-litre class,
(2.5-litre turbocharged horizontally-opposed Boxer engine)
- 2005 - Australia's Best Cars, Best Luxury Car under \$57,000, Subaru Liberty 3.0R
- 2004 - Australia's Best Cars, Best Mid-Size Car over \$28,000, Subaru Liberty 2.5i
- 2001 - Australia's Best Cars, Best Mid-Size Car over \$25,000, Subaru Liberty RX
- 2000 - Australia's Best Cars, Best Mid-Size Car over \$25,000, Subaru Liberty RX
 - Which Car, Gold Medal, Medium Car Category, Subaru Liberty
 - Autocar, New Zealand, Car of the Year, Subaru Liberty
 - Autocar, New Zealand, Best Medium Car, Subaru Liberty
 - J.D. Power and Associates/Top Gear U.K. Customer Satisfaction Study,
Gold Award – Subaru Liberty
- 1999 - NRMA/RACV, Best Mid-Size Car – Subaru Liberty RX
- 1998 - Wheels Magazine, Wheels Car of the Year – Subaru Liberty Wagon
- 1994 - Wheels Magazine, Car of the Year – Subaru Liberty

Subaru Australia reserves the right to vary vehicle specifications and standard features in Australia from those detailed in this brochure. Vehicles shown in this brochure may be fitted with accessories available at additional cost. No part of the brochure can be reproduced without written permission from Subaru Australia. Printed in Australia.

www.subaru.com.au

© Copyright 2020 – Subaru (Aust) Pty Limited. All rights reserved.
Subaru (Aust) Pty Limited ABN 95 000 312 792 (Subaru Australia) PO Box 8311, Norwest NSW 2153 Toll Free: 1800 226 643



SUBARU