



PORSCHE



The Cayman





Cayman models	6	Porsche Exclusive	120
Cayman concept	8	Porsche Car Configurator	121
Design	12	Porsche Driving Experience	122
Cayman	18	Factory collection	123
Cayman S	22	Panorama	124
Cayman GTS	26	Summary	126
Drive	30	Technical data	128
Engine	32	Index	132
Transmission	40		
Chassis	46		
Safety and environment	62		
Safety	64		
Environment	70		
Interior	74		
Interior and comfort	76		
Audio and communication	92		
Personalisation	102		

The law of inertia need never mean a dull moment.

The Cayman models.



**You don't let anyone dictate
the direction your life should take.**

Cayman concept.

In sports car construction you have to think ahead. But is that enough? Can that be all? Do we really not want to know what's on the left and right? It's time to leave the straight and narrow and take a direction to which the road itself bows down. It's time for a sports car that turns the curve into a code and completely reinterprets passion for the sports car

with a compelling mid-engine concept, which provides a low and central centre of gravity for a precise and direct driving feel and offers improved performance at the same time as enhanced efficiency. More free-revving and thrusting than ever before, it combines innovative technologies with an intelligent lightweight construction for the optimum power-to-weight ratio.

The chassis focuses on delivering power to the road and especially the corner. The look is unmistakable, with every line and every edge eager for more.

The Cayman models. Built according to our own style and with respect for the code of the curve.





Let's show the wind who's boss.

Exterior design.

Character, profile and a clear point of view. These values have been encoded in the Cayman genes since the very beginning. And it certainly shows.

The front is dominated by the prominent wings for which Porsche is renowned and features succinctly styled headlights inspired by the Porsche racing heritage of the 1960s and 1970s. With its large and

dynamic air intakes, the front end reinforces the car's air of power and aggression. The front light units integrated in the air intakes are a classic feature of Cayman styling and incorporate LED daytime running lights and position lights for active safety.

The silhouette is sleek, the wheelbase long, the wheels large – up to 20 inches if

you like. The narrow side windows together with the forward-shifted windscreen and the roofline extending far into the rear give added emphasis to the Cayman's personality. As does the design of the doors. With its dynamic contouring, it improves airflow to the side air intakes for the purpose of cooling and supplying oxygen to the boxer engine.

In conjunction with the wide track, the rear gives the impression of a sculpted and honed physique. The rear wing is more than a stunning eye-catcher. It deploys automatically at 74 mph. Its effective aerodynamic active surface is large and the amount of lift low. Retracted, the separation edge of the rear wing makes a seamless transition to the LED taillights. The integrated direction

indicators are slender and in line with the wing. The broad brake light is an integral feature of the large rear screen.

The rear apron with centrally framed stainless-steel tailpipe (dual tube on the Cayman S and Cayman GTS) adds the powerful finishing touch.

Where the Cayman models want to go is clear at first glance. Every line and every technical detail are focused in one direction: forwards. Every aspect tells a story – of character and insatiable forward thrust.





Vital to advancement: a clear line.

Interior design.

The ideal line. An idea from the racetrack that we have made standard. Everything following one clear line. Everything where it belongs. In the interior it's called ergonomics. Which is how sports performance has become an everyday concept.

The development is focused on the driver. The interior helps the driver concentrate on the essentials. With a feeling of open space and plenty of freedom of movement around the low-positioned standard Sports seats. An imposing feature of the interior is the ascending centre console.

We believe that the gear lever should be positioned close to the steering wheel to enable fast, sporty and ergonomic gearshifts. As you would expect, the ignition lock is located nearest the door. The three-spoke sports steering wheel falls perfectly to hand. Behind it are the three central round instruments, which provide you with all the important information you need.

The generously proportioned luggage compartment is located underneath the wide rear screen. The large rear hatch above the exquisitely styled luggage

compartment boasts a wide opening angle. The luggage protection bar is finished in brushed aluminium just like the inlay between the upper and lower luggage compartments. Storage compartments on both sides offer additional stowage room.

In short, our styling strategy for the Cayman followed a clear line. The finishing touches are down to you. We offer a comprehensive range of personalisation options and a wide selection of colours and materials.

1 Cayman S with leather interior, SportDesign steering wheel, Porsche Doppelkupplung (PDK) and other optional equipment



The best thing about unconventional routes? Their curves.

Cayman.

Exploring your own direction takes unswerving conviction, but that doesn't mean you should have to forgo cornering fun – especially not in the Cayman.

Impressive driving dynamics with practically zero pitch and roll are ensured by the precise, lightweight chassis. Giving

you the benefit of a more comfortable and safer drive.

The front section, with its large air intakes, is distinctive. The 18-inch Cayman wheels with tyre pressure monitoring (TPM) are succinctly styled. The brake system with four-piston

aluminium monobloc fixed calipers in black is robust. The sound from the central tailpipe in brushed stainless steel is unmistakable.

And inside? High-quality materials are used in the interior. The steering wheel rim, gear lever/selector and the door pull

inlays are finished in leather. And another striking feature are the silver-coloured details such as those found on the dashboard trim strip, the side and centre air vent surrounds and the centre console.

The Cayman. Wouldn't it be boring if an unswerving conviction always led you down the straight road?



Cayman engine.

The Cayman is equipped with a free-revving 2.7-litre flat-six engine with direct fuel injection (DFI) and VarioCam Plus. It develops 202 kW (275 hp) at 7,400 rpm. The maximum torque of 290 Nm is available across a wide speed range from 4,500 to 6,500 rpm.

The Cayman with six-speed manual transmission accelerates from

0 to 62 mph in 5.7 seconds and reaches a top speed of 165 mph. With the optional Porsche Doppelkupplung (PDK) it completes the 0 to 62 mph sprint in 5.6 seconds and achieves a top speed of 164 mph. The optional Sport Chrono Package (p. 59) in conjunction with PDK offers a further performance boost. With Launch Control in the Sport Chrono Package, the Cayman accelerates from 0 to 62 mph in just 5.4 seconds.

For fuel consumption and CO₂ emissions, please refer to page 130.

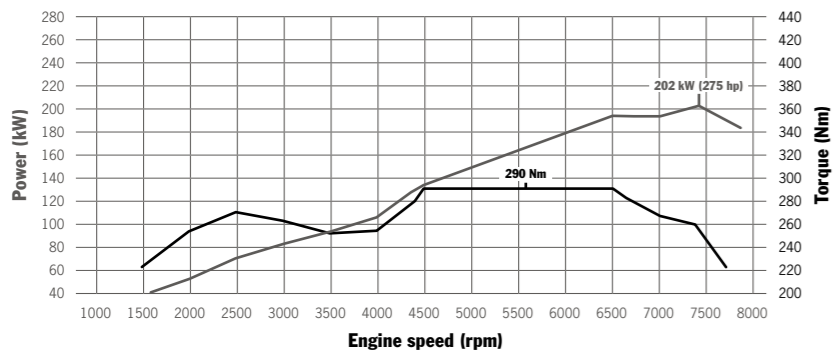

Cayman: 202 kW (275 hp) at 7,400 rpm, 290 Nm between 4,500 and 6,500 rpm



Don't you think your path in life deserves a few curves?

Cayman S.

Sometimes the fastest route is over the longest roads. Sometimes every turn, every detour brings us closer to our objective. Especially if the objective is a dynamic drive. An objective that the Cayman S knows only too well.

The lightweight chassis is an excellent match for the powerful engine. Optional Porsche Active Suspension Management (PASM) and Porsche Torque Vectoring (PTV) with rear differential lock, also available as an option, offer increased agility and driving pleasure at the same time as improving traction and handling.

Bi-Xenon headlights are fitted as standard on the Cayman S. The precisely styled LED front light units emphasise the front air intakes. At the rear, the twin tailpipe in brushed stainless steel is located in the centre and produces the typically resonant Porsche sound.

Imposing 19-inch Cayman S light-alloy wheels with a classic five-spoke design are fitted as standard. Safety is ensured by the four-piston aluminium monobloc fixed-caliper brakes. The front brake discs are 15 mm larger than those on the Cayman and the brake calipers are finished in red.

Inside, the door panel armrests and the storage compartment lid in the centre console are additionally upholstered in leather. The rev counter has an aluminium-coloured dial.

The Cayman S. Never was the journey so much the destination.



Cayman S engine.

The Cayman S draws its agility from a 3.4-litre flat-six engine with direct fuel injection (DFI) and VarioCam Plus. It produces 239 kW (325 hp) at 7,400 rpm and its maximum torque of 370 Nm is generated between 4,500 and 5,800 rpm. The Cayman S with six-speed manual transmission races from 0 to 62 mph in 5.0 seconds and reaches a top speed of 175 mph.

Even sportier figures are achieved with optional Porsche Doppelkupplung (PDK): 4.9 seconds from 0 to 62 mph and a top speed of 174 mph. In conjunction with Launch Control in the optional Sport Chrono Package, the Cayman S finishes the sprint to 62 mph in just 4.7 seconds.

For fuel consumption and CO₂ emissions, please refer to page 130.

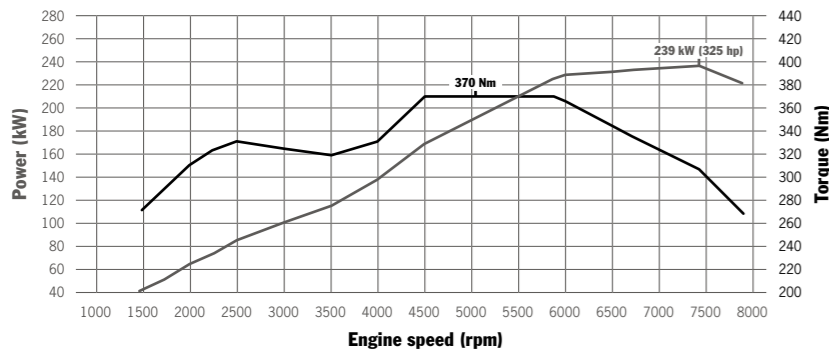

Cayman S: 239 kW (325 hp) at 7,400 rpm, 370 Nm between 4,500 and 5,800 rpm



The car your mother always warned you about.

Cayman GTS.

How does a curve become uniquely thrilling? With three letters: GTS. The road is immediately converted to driving pleasure. For the most unadulterated sports car feel ever.

A promise that is kept, first of all, by the exterior. A redefined front with

characteristic contouring and large air intakes. An impression that is reinforced by the smoked LED daytime running lights and position lights. Bi-Xenon headlights including Porsche Dynamic Light System (PDLS) are fitted as standard and are black on the inside. An extremely impressive feature are the 20-inch

Carrera S wheels with their dynamic 10-spoke design. Porsche Active Suspension Management (PASM) adjusts the damping forces according to driving style and conditions. The suspension is also 10 mm lower than that of the Cayman S. At the rear, the smoked taillights and the redesigned apron give

added emphasis to the pure sports performance delivered by the Cayman GTS. The look is completed by a black, twin sports tailpipe – for that unmistakable Porsche sound, made even more vivid by the sports exhaust system. All culminating in the black 'Cayman GTS' logo on the rear.

In conjunction with the standard black leather interior, Alcantara is used on the SportDesign steering wheel, the gear lever-selector, the dashboard lower section and the A-pillars. It is also featured in the seat centres of the Sports seats Plus, which also have the 'GTS' logo embroidered on the headrests.

The Cayman GTS. Revised and improved for more cornering – on every curve. In other words: purity, but without sacrifice.



Cayman GTS engine.

The performance-enhanced 3.4-litre flat-six engine with direct fuel injection (DFI) and VarioCam Plus delivers 250 kW (340 hp) at 7,400 rpm. That's 11 kW (15 hp) more than the Cayman S. Maximum torque of 380 Nm is available over the range from 4,750 to 5,800 rpm. A consistently lightweight construction ensures an extraordinary low power-to-weight ratio of only 5.4 kg/kW (4.0 kg/hp).

With the six-speed manual transmission, the Cayman GTS accelerates from 0 to 62 mph in just 4.9 seconds and boasts a top speed of 177 mph.

Performance is even further enhanced by the optional Porsche Doppelkupplung (PDK), with which it sprints from 0 to 62 mph in a mere 4.8 seconds. And with Launch Control in the standard Sport Chrono Package, it achieves it in just 4.6 seconds.

For fuel consumption and CO₂ emissions, please refer to page 130.

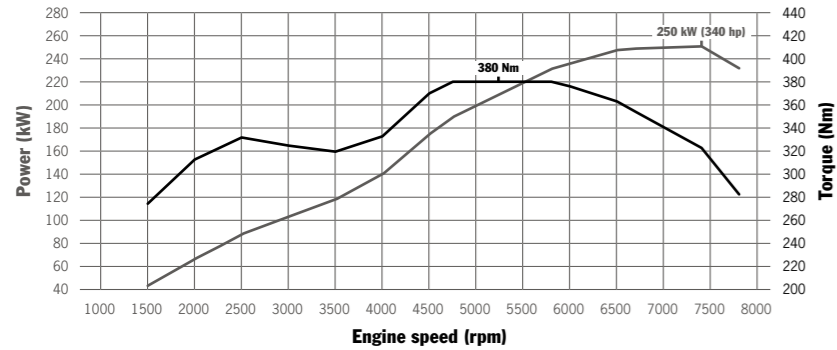

Cayman GTS: 250 kW (340 hp) at 7,400 rpm, 380 Nm between 4,750 and 5,800 rpm





The natural place for outstanding performance: centre stage.
Drive.

What does a mid-mounted engine do for you? It backs you up.

Boxer engines.

Inner strength, the will to advance and a clear positioning. These are important prerequisites for the creation of any sports car, and we also found them to be precisely the right requirements for this drivetrain.

This is why the Cayman models are equipped with a compact, mid-mounted boxer engine positioned no further than 30 cm behind the driver. This unorthodox approach has crucial strengths. A substantial amount of vehicle weight is concentrated close to the middle of the vehicle. The centre of gravity is low

and central and the weight is distributed uniformly between the front and rear axles. The tangible effect for you is well-balanced handling and excellent mobility, particularly in corners.

Inner values are defined by high power plus comparatively low fuel consumption

and emission figures. A philosophy that applies the engineering principles of the racetrack to the road.

The engines are equipped, as standard, with VarioCam Plus and direct fuel injection (DFI), as well as efficiency-enhancing technologies such as auto

start/stop, electrical system recuperation and advanced thermal management.

So what can you expect from the driving experience? Direct responses to every burst of acceleration, dynamic handling in every corner and the inevitable pain of separation at the end of every drive.

1 Engine, gearbox and exhaust system in the Cayman S

For fuel consumption and CO₂ emissions, please refer to page 130.



Direct fuel injection (DFI).

Direct fuel injection (DFI) is featured as standard in the Cayman models. Multi-hole injectors deliver fuel directly into the combustion chamber with millisecond precision. DFI improves the internal cooling of the combustion chamber by having the mixture prepared directly in the cylinder. This allows for a higher compression ratio, which helps to deliver greater power output at the same time as enhanced engine efficiency.

VarioCam Plus.

VarioCam Plus is a two-in-one engine concept for adjusting the intake camshafts and switching the lift of the

intake valves. The system differentiates between driver inputs that typify normal, everyday driving and those that demand maximum performance. The system then imperceptibly adapts valve operation to the prevailing conditions.

This results in instant acceleration and extremely smooth running with comparatively low fuel consumption.

Integrated dry-sump lubrication.

Integrated dry-sump lubrication ensures a reliable supply of oil, even when a sporty driving style is adopted and the vehicle is experiencing powerful lateral acceleration. It also features additional cooling functions. The electronic oil pump

is activated as and when needed. It also reduces fuel consumption, thus lowering emissions.

Thermal management.

Thanks to the purposeful control of heat flow and the on-demand, gradual activation of the various cooling circuits, the engine and gearbox warm up to normal operating temperature more rapidly. The resulting reduction in friction also reduces fuel consumption and CO₂ emissions. During sporty driving, thermal management also acts to reduce temperatures so as to maintain a high degree of performance.



Engine management.

The electronic engine management system ensures optimum engine performance at all times. It regulates all engine-related functions and assemblies. The results are optimum power output and torque with comparatively low fuel consumption and emissions – whatever the driving style.

SPORT button.

The SPORT button on the centre console is fitted as standard. When selected, 'Sport' mode is activated to provide a greater response and enhanced driving pleasure. The engine reacts even more directly to the accelerator pedal, the rev-limiter is adjusted to a harder setting and the driving style.

engine dynamics are tuned for performance driving. At the same time, the auto start/stop function is deactivated automatically.

With optional Porsche Doppelkupplung (PDK), the shift points are reconfigured to offer higher and even sportier rpm bands. Shift times are reduced and gearshifts become firmer and more immediate, while

throttle-blip downshifts are accompanied by an even more emotive engine sound. Coasting mode (p. 42) is deactivated automatically.

Auto start/stop function.

The auto start/stop function, which is integrated as standard in the Cayman models, switches off the engine if, for

example, you stop at traffic lights, select neutral and then release the clutch pedal. In cars with Porsche Doppelkupplung (PDK), it is simply a case of applying and holding the brake when you are in a wait situation. All audio and communication systems remain switched on.

Electrical system recuperation.

Another efficiency-enhancing feature of the Cayman models is intelligent electrical system recuperation. The vehicle battery is recharged by the generator, especially when braking. Thanks to this selective recharging, when you accelerate, the

maximum possible output of the engine can be directed straight to the road because the electrical systems are supplied mainly by the energy that was stored in the battery during the braking phase.

1 SPORT button
2 Auto start/stop button

For fuel consumption and CO₂ emissions, please refer to page 130.



Exhaust system.

In the Cayman models, each cylinder bank has its own stainless-steel exhaust tract. Integrated catalytic converters and four corresponding Lambda sensors are used to keep emissions low. Downstream of the respective rear silencers, the system converges into a connecting tube and a single (Cayman) or twin (Cayman S and Cayman GTS) tailpipe.

Sports exhaust system.

The switchable sports exhaust system with its distinctive twin sports tailpipe is standard in the Cayman GTS and available as an option for the Cayman and Cayman S. Finished in black for the Cayman GTS. For an even more intensive sports car sound at the press of a button.

- 1 Standard tailpipe on the Cayman
- 2 Standard tailpipe on the Cayman S
- 3 Standard tailpipe on the Cayman GTS





**You've developed your own strategies for advancement.
So have we.**

Transmission.

Six-speed manual transmission.

The Cayman models are equipped as standard with the six-speed manual transmission. Gearshifts are smooth, precise and optimally adapted to the respective engine characteristics. Shift throws are short and the gear lever is easy to operate, providing a truly sporty, direct driving experience. The upshift indicator located in the central round instrument helps you to maximise fuel efficiency.

Porsche Doppelkupplung (PDK).

Of course, you could let us take care of the gearshift strategy so that you can devote all your attention to your cornering strategy, with the optional 7-speed Porsche Doppelkupplung (PDK) featuring both manual and automatic modes. PDK offers extremely fast gear changes with no interruption in the flow of power, improved acceleration over the manual transmission, very short response times, reduced fuel consumption and a distinct increase in comfort.

PDK is essentially two gearboxes in one, thus requiring two clutches. This double-clutch transmission provides an alternating, non-positive connection between the two half gearboxes and the engine by means of two separate input shafts. The flow of power from the engine is transmitted through one half gearbox and one clutch at a time, while the next gear is preselected in the second half gearbox. Therefore, during a gear change, one clutch simply opens and the other closes simultaneously, enabling gear changes to take place within milliseconds.

- 1 Gear lever for six-speed manual transmission
- 2 Porsche Doppelkupplung (PDK) gear selector
- 3 Gearshift switch on sports steering wheel in conjunction with PDK



1



2



3

For fuel consumption and CO₂ emissions, please refer to page 130.

With the SPORT button selected, the full advantages of PDK are brought into play: a more immediate response to throttle inputs, relatively short shift times and swift throttle-blip downshifts on overrun, such as when braking into a corner, and always accompanied by an emotive engine sound.

When combined with the optional Sport Chrono Package (standard in the Cayman GTS), the gearshifts of PDK are sportier, shift times shorter. Other gearshift strategies are also available – for uncompromising driving enjoyment.

Coasting.

Available with Porsche Doppelkupplung (PDK), coasting enables you to save even more fuel where the situation allows. The engine is decoupled from the transmission to prevent deceleration caused by engine braking. The vehicle can then make optimum use of its momentum and coast for longer distances. This lowers fuel consumption noticeably, without losing any comfort or sports performance.





S VM 906



**How do we nurture our relationship with the driver?
By purposefully strengthening our bond with the road.**

Chassis.

Strong relationships need sincerity, common goals and the ability to overcome difficult situations in unison.

The chassis of the Cayman models develops a strong bond with the road. It is specifically matched to the high-power output of the respective engine. Axle components are made predominantly of aluminium, which helps to keep the weight of the vehicle and its unsprung masses low. The results are impressive driving dynamics with practically zero pitch and

roll, high levels of comfort and safety, and lower fuel consumption.

The Cayman models have a wide track and a long wheelbase. This improves stability. The independent suspension features lightweight spring-strut axles with longitudinal and transverse links. The cross member at the front axle has been refined for optimum stiffness and robustness. How does this benefit you? Greater directional stability, sharper steering precision and sportier handling.

Porsche Active Suspension Management (PASM).

PASM is optional, or standard for the Cayman GTS. This electronic damping control system actively and continuously regulates the damping force for each wheel according to the road conditions and driving style. In addition, the suspension is 10 mm lower than that of the standard setup.

1 Front axle of the Cayman S
2 Rear axle of the Cayman S

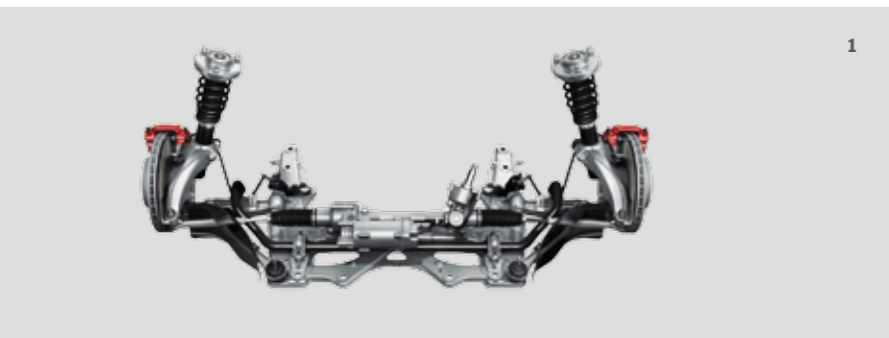

The system is always active in the background, ready to assist you automatically without you having to enable it. Nevertheless, two modes are available at the push of a button so that

you can adapt handling to suit your preferred driving style: 'Normal', which is a blend of performance and comfort, and 'Sport', where the setup is much firmer. Depending on the mode selected,

therefore, PASM can be sportier and more comfortable than the standard chassis, optimising contact between each individual tyre and the road for even less roll and pitch. The results are tangible:

increased driving stability, enhanced driving pleasure and improved performance.

Steering.

The Cayman models have electromechanical steering. With a variable steering ratio, the steering system responds precisely and directly –

and more efficiently. The electric motor uses energy only when the steering wheel is actually turned. And the absence of hydraulic fluid eliminates the need for servicing.

Power steering Plus, the optional speed-sensitive power-steering system, ensures easier manoeuvring and parking, thus providing even greater comfort.



Wheels and tyre pressure monitoring (TPM).

Performance calls for stability. The Cayman is therefore equipped with 18-inch light-alloy wheels as standard. The Cayman S has 19-inch wheels with a classic five-spoke design, ensuring firm contact between the vehicle and the road. The Cayman GTS emphasises its roadholding capacity with 20-inch Carrera S wheels and a dynamic 10-spoke design.

Wheels up to 20 inches are available from our list of options.

Tyre pressure monitoring (TPM) is fitted as standard. It sends warnings to the on-board computer's display in the event of low tyre pressure. The screen in the instrument cluster enables the driver to check the pressure in all four tyres.

The system updates quickly and accurately after an engine start, tyre pressure correction or wheel change – for your safety and convenience.

- 1 18-inch Cayman wheel
- 2 19-inch Cayman S wheel
- 3 20-inch Carrera S wheel



Brakes.

Performance is reflected in excellent acceleration values. And we take account of both positive and negative acceleration. Which is why Porsche also traditionally sets standards for stopping power and stability. Braking power is a multiple of engine power.

The Cayman models are equipped with four-piston aluminium monobloc fixed-caliper brakes. This design means that, not only are the brakes extremely resistant to deformation, they are lightweight for a particularly fast and sensitive braking response. Even during continuous use. Brake cooling has also been optimised by the brake ventilation system with brake air spoilers at the front and rear axles.

The dynamics of the Cayman models also demand appropriate brake discs. All Cayman brake discs are internally vented and cross-drilled for improved braking in wet conditions. With a diameter of 330 mm, the front brake discs of the Cayman S and Cayman GTS are 15 mm larger than those of the Cayman. The diameter of the rear brake discs is 299 mm on all models.

Porsche Ceramic Composite Brake (PCCB).

The optional Porsche Ceramic Composite Brake (PCCB) has proven itself in motorsport. The cross-drilled brake discs have a diameter of 350 mm front and rear for even more formidable braking performance.

The use of six-piston aluminium monobloc fixed brake calipers on the front axle and four-piston units at the rear – all painted in yellow – ensures extremely high brake forces which, crucially, are exceptionally consistent. PCCB enables shorter braking distances in even the toughest road and race conditions.

Another key advantage of the ceramic braking system is the extremely low weight of the ceramic brake discs, which are approximately 50% lighter than standard discs of similar design and size. As well as enhancing performance and fuel economy, this also represents a major reduction in unsprung and rotating masses. The consequence of this is better roadholding and increased comfort, particularly on uneven roads.

Alongside the regular servicing work performed within the standard service intervals, additional servicing should be performed if used on the race track.

Electric parking brake.

The electric parking brake, which can be activated and deactivated manually, is released automatically as you pull away with your seat belt fastened. A hold function is integrated as standard. It assists you in making a comfortable, smooth and roll-free start on an incline.

- 1 Standard brake on the Cayman
- 2 Standard brake on the Cayman S and Cayman GTS
- 3 Porsche Ceramic Composite Brake (PCCB)





Porsche Stability Management (PSM).

Porsche Stability Management (PSM) is fitted as standard. This system automatically maintains stability and traction even at the limits of dynamic driving performance. Sensors continuously monitor the direction, speed, yaw velocity and lateral acceleration of the car. Using this information, PSM is able to calculate the actual direction of travel at any given moment. If the car begins to oversteer or understeer, PSM applies selective braking on individual wheels in order to restore stability.

When accelerating on wet or low-grip road surfaces, PSM improves traction – as well

as agility, control and safety – using the automatic brake differential (ABD) and anti-slip regulation (ASR). Integrated ABS is designed to minimise braking distances.

Want an even sportier drive? Then you can switch off PSM. For your safety, however, PSM remains set to intervene if the vehicle is braked and ABS assistance is required. ABS and ABD remain permanently enabled.

Also included with PSM are engine drag torque control (EDTC), the precharging of the brake system and brake assist. If you suddenly release the accelerator pedal, PSM automatically prepares for your next

action: the braking system is precharged so that the brake pads are already in light contact with the brake discs. Maximum braking power is therefore achieved much sooner. Brake assist detects a panic braking situation and generates the brake pressure required for maximum deceleration.

In brief: PSM increases driving stability and safety as well as the agility you have come to expect from a Porsche.

Porsche Torque Vectoring (PTV).

This optional system for increasing dynamic performance and stability varies the distribution of torque to the rear wheels and includes a mechanically locking rear differential.

When the car is driven assertively into a corner, moderate brake pressure is applied to the inside rear wheel. Consequently, an additional rotational pulse (yaw movement) is induced around

the vehicle's vertical axis in the direction of the turn.

This results in a direct and sporty steering action as the car enters the corner.

At low and medium vehicle speeds, PTV significantly increases agility and steering precision. At high speeds and when accelerating out of corners, the rear differential lock ensures greater driving stability and traction on road surfaces

with varying grip, including the wet and snow.

The results are remarkable stability, great traction and excellent cornering dynamics at all speeds, coupled with precise

steering and stable load transfer characteristics through every twist and turn of your journey.





**You don't play for time.
But if you did, you'd do it properly.**

Sport Chrono Package.

It usually takes intensive training to achieve optimum results. In the Cayman models, all you need do is press a button: with the Sport Chrono Package, an option for the Cayman and Cayman S and fitted as standard in the Cayman GTS, it provides simultaneous enhancement for the chassis, engine and transmission – accompanied by an even more emotive sound.

In addition to the performance display combined with a digital and an analogue stopwatch, the Sport Chrono Package also includes dynamic gearbox mounts (p. 60). Another component is the SPORT PLUS button. When this is pressed, optional Porsche Active Suspension Management (PASM), a standard feature of the Cayman GTS, switches to 'Sport'

mode for harder damping and more direct steering and, therefore, even more intensive roadholding.

The trigger threshold for PSM is raised. Agility is perceptibly enhanced when braking for corners with PSM, allowing even sportier braking and exit acceleration. For even more dexterity, PSM can be set to standby while the car is still in SPORT PLUS mode. For safety, it is set to intervene automatically only when ABS assistance is required.

The throttle-blip function is enabled to produce even sportier gearshifts. A managed burst of throttle ensures smooth load changes for increased stability, making the gearshift process an even more engaging experience. In conjunction

with optional Porsche Doppelkupplung (PDK), the Sport Chrono Package comes with two additional functions for a sporty drive that borders on a motorsport experience. The first is 'Launch Control', which is designed to produce a racing start.

The second function is the 'motorsport-derived gearshift strategy'. In this mode, PDK is designed for very short shift times and optimum shift points, while torque boosts during gear changes provide the maximum acceleration available. This involving experience is further enhanced by overrun downshifts and the throttle-blip function for uncompromising driving pleasure.

An additional display in the steering wheel and instrument cluster indicates whether the SPORT or SPORT PLUS button and, with PDK, Launch Control have been activated. In conjunction with optional Porsche Communication Management (PCM), a special display enables you to view, store and evaluate lap times or other driving times. It shows the total driving time, lap distance, lap number and lap times recorded so far.

- 1 Sport Chrono display on the sports steering wheel in conjunction with Porsche Doppelkupplung (PDK)
- 2 Sport Chrono stopwatch
- 3 SPORT and SPORT PLUS button



Dynamic gearbox mounts.

The Sport Chrono Package also includes dynamic gearbox mounts. This electronically controlled system minimises the oscillations and vibrations of the entire drivetrain, particularly the engine, and combines the benefits that otherwise

distinguish hard and soft gearbox mounting arrangements.

A hard gearbox mounting delivers optimum dynamic performance because it offers a high degree of handling precision. Soft gearbox mounts, on the other hand,

minimise oscillations and vibrations. While comfort is improved on uneven road surfaces, this comes at the expense of dynamic performance.

Dynamic gearbox mounts adapt their stiffness and damping characteristics to

changes in driving style and road surface conditions. This has been achieved by the use of a fluid with magnetic properties in interaction with an electrically generated field. For the driver, the results are tangible. Handling is perceptibly more stable under load change conditions and

in fast corners. Whenever a less assertive driving style is adopted, the dynamic gearbox mounts automatically soften to enhance comfort.

The result is uncompromisingly sporty performance in corners – as well as a high degree of comfort.

The SPORT or SPORT PLUS button enables you to switch the dynamic gearbox mounts from 'Normal' to 'Sport'

or 'Performance' mode. In conjunction with optional PCM, the colour screen in the right-hand round instrument enables you to view the lateral and longitudinal forces as they act on the vehicle.

1 Dynamic gearbox mounts

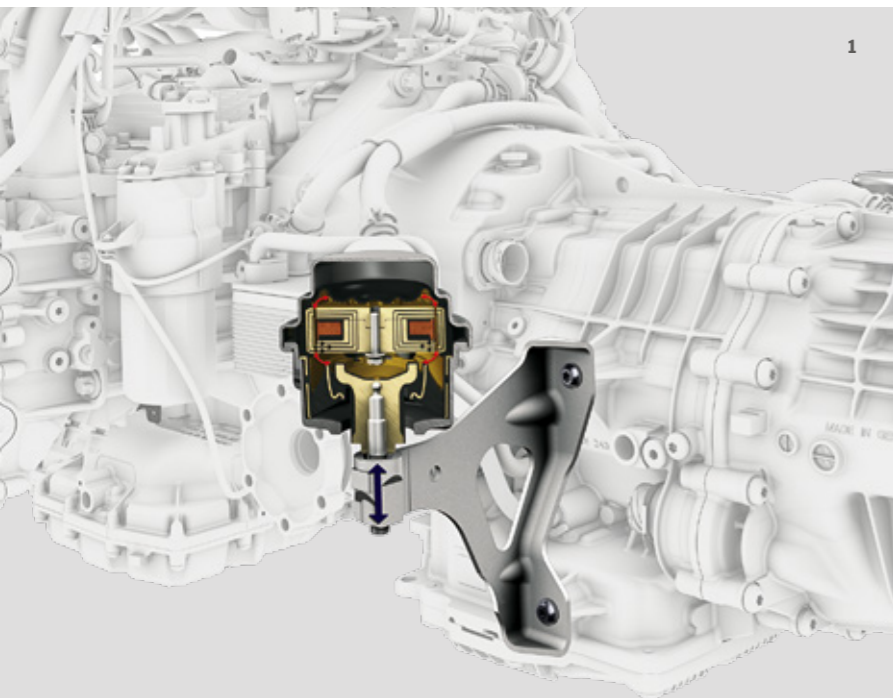



A genuine sports car is defined not by its limits
but by what it keeps in reserve. **Safety and environment.**

**It takes courage to set out on your own path.
And you'll need a broad view to reach your destination.**

Safety.

It's always worth exploring your own direction, even if you never know exactly where this will lead. For this reason, it pays to have an ingenious safety concept on board that employs components that are just as performance-oriented as the drivetrain.

In the case of the Cayman models, this concept involves an innovative bodywork construction, the stiffness of which has been purposefully optimised despite an overall weight-saving – a combination that delivers increased stability and agility. It includes an interior that provides reliable protection in the event of an accident.

It uses a chassis and brakes that have been specifically matched to the power output that the Cayman models are able to develop. And it is enhanced by intelligent control systems, such as Porsche Stability Management (PSM), which intervene when you reach the limits of sporty performance.

Some things are indispensable for a broad view – including a clever lighting concept with powerful headlights and, of course, driver assistance systems designed to give you the right information at the right time so that you can devote all your attention to the next corner.

Engineered body design.

The bodyshell of the Cayman models is based on an intelligent lightweight principle involving the composite construction of aluminium and steel. The use of dissimilar but precisely combined components makes it possible to utilise specific material properties exactly where they are needed. Not only does this provide a high degree of safety for the driver, it also offers a considerable weight saving compared with the bodyshell of the previous model. This is why the doors, luggage compartment lid and rear hatch are made of aluminium.

The crumple zones in the front and rear aprons feature integral light-alloy bumpers, while impact absorbers offer additional safety. For the protection of occupants, energy-absorbing padding is used selectively in important areas within the passenger cell.



Airbags.

To protect the driver and passenger, the Cayman models are equipped as standard with full-size airbags, which are inflated in two stages depending on the severity and type of accident (e.g. frontal or offset

frontal). In less serious accidents, the airbags are only partially inflated, thereby minimising discomfort to the occupants.

In addition to the central airbag control unit on the transmission tunnel, a pair of

impact sensors are located near the headlights. This allows a crash to be detected and evaluated far sooner and with considerably greater accuracy.

Porsche Side Impact Protection System (POSIP).

The Cayman models are equipped as standard with the Porsche Side Impact Protection System (POSIP). It comprises two side airbags on each side. An integral

thorax airbag is located in the outer side bolster of each seat, while the door panels each contain an upwards-inflating head airbag. Each thorax airbag has a volume of 10 litres and each head airbag 15 litres, ensuring excellent protection in

the event of a side impact. POSIP additionally includes steel side impact protection elements in the doors.

- 1 Engineered body design
- 2 Airbags and Porsche Side Impact Protection System (POSIP)



Lights.

A design is either fascinating or functional. The front and rear lights of the Cayman models can be both. Clear glass halogen headlights are fitted on the Cayman as standard. The Cayman S is equipped as standard with Bi-Xenon headlights while the Cayman GTS has Bi-Xenon headlights including the

Porsche Dynamic Light System (PDLS). Daytime running lights and position lights are integrated in the air intakes of all Cayman models. Also standard in all Cayman models is automatic headlight activation which, depending on the ambient light conditions, automatically switches between daytime running lights and dipped beam.

LEDs provide powerful illumination, respond rapidly to driver input, are more energy efficient and have a longer service life. They are also used in the rear lights. Ensuring greater safety and creating a look that is unmistakable, day and night.

Bi-Xenon headlights including Porsche Dynamic Light System (PDLS). The Porsche Dynamic Light System (PDLS) is standard equipment in the Cayman GTS and available as an option for the other Cayman models. It comprises Bi-Xenon main headlights with halogen auxiliary main beam headlights, a headlight cleaning system and automatic

dynamic range control to provide uniform illumination of the road with both dipped or main beam. The dynamic cornering light function swivels the main headlights towards the inside of a bend based on the steering angle and road speed. In addition, PDLS adapts light distribution to suit your current driving speed. The adverse weather function is activated

when the rear fog light is switched on. This provides increased safety – not least in corners and not only at night.

Porsche Dynamic Light System Plus (PDLS+).

The optional Porsche Dynamic Light System Plus (PDLS+) has an additional feature. Dynamic main beam control

identifies the car in front as well as oncoming traffic and adapts the range of the light cone automatically to the particular situation, switching smoothly between dipped and main beam.

- 1 Bi-Xenon headlights including PDLS
- 2 Direction indicator
- 3 Daytime running lights and position lights on the Cayman and Cayman S
- 4 Night design at the front of the Cayman GTS
- 5 Night design at the rear of the Cayman GTS
- 6 Taillight
- 7 Brake light
- 8 Taillight and direction indicator





**When it comes to sports cars, every gramme counts.
Especially every gramme of CO₂.**

Environment.

You aren't the only one looking for ways to improve your performance. In an era of intensifying debate about global climate change and CO₂ emissions, automotive manufacturers are among those asking themselves how they can contribute to environmental protection. Our answer has long been the same: a combination of high power output and high efficiency.

Porsche has reduced fuel consumption across all model ranges by a double-digit percentage compared with the respective previous model, even though performance has been increased in every generation.

This is made possible by an efficient drive concept, including direct fuel injection (DFI) and VarioCam Plus, a lightweight construction, optimised aerodynamics and low rolling resistance.

The environmental management team at the Porsche Development Centre in Weissach demonstrates a high level of environmental responsibility. Here, technological developments are carried out with environmental protection in mind. The goal is to enhance performance – but preferably not at the expense of the environment.

Emission control.

Vehicles manufactured by Porsche demonstrate that even high-performance sports cars can achieve moderate fuel consumption and exhaust emission values in their respective category.

This is accomplished by the use of fuel-efficient technologies such as direct fuel injection, VarioCam Plus, thermal management, electrical system recuperation, auto start/stop and, in conjunction with optional Porsche Doppelkupplung (PDK), coasting.

The newly developed catalytic converters also provide efficient emission control, while the stereo Lambda control circuitry manages and monitors each cylinder bank separately. For each exhaust tract, oxygen sensors, together with the engine electronics and injectors, regulate the composition of the exhaust gas, while another Lambda sensor on each cylinder bank monitors pollutant conversion in the respective catalytic converter.

For fuel consumption and CO₂ emissions, please refer to page 130.

Fuel economy and recycling.

Intelligent lightweight construction is, and always has been, a fundamental aspect of the Porsche philosophy – for both technical and ecological reasons. This combination forms the basis for achieving low fuel consumption values in conjunction with high performance. On the technical side, various components are made with a high proportion of aluminium, magnesium, plastics and super-high-strength sheet steel. The materials used have been selected for their ability to withstand load, yet they are considerably lighter than conventional steel. As a result, the bodyshell of the Cayman models has a light-alloy content of approximately 44 %.

On the ecological side, all materials used are meticulously selected. We use only

state-of-the-art components, with priority given to products manufactured in a sustainable manner where possible. All synthetic components are easily recyclable and each material is labelled to facilitate its separation for recycling. The reduction in the number of plastic variants helps to ensure more efficient recycling. Recycled plastics are used where they meet our exacting technical requirements.

In short, the Cayman is around 95 % recoverable.

In addition, Porsche uses a high proportion of environmentally friendly water-based paints. For us, environmental protection does not begin with the vehicle manufacturing process. It starts at the planning and development stage.

Fuel.

The Cayman models are designed to operate on fuels with an ethanol content of up to 10%. Ethanol has a positive impact on the CO₂ balance since the plants grown for the production of this biofuel also absorb CO₂ from the atmosphere. The release of hydrocarbons from the fuel system has been minimised, thanks to the active carbon filter and the multilayered material from which the fuel tank is made.

Servicing.

Long service intervals offer clear advantages. For you, they reduce costs and save time. For the environment, they assist in the sparing use of consumables and replacement parts. For full details of service intervals, please refer to the separate price list.

For fuel consumption and CO₂ emissions, please refer to page 130.



Will you ever be able to sit back and relax?
Maybe. Whilst you're dashing along. **Interior.**



Suited to you. Not adapted to you.

Interior and comfort.

You aren't the cosy type, but you do appreciate the value of comfort and convenience.

The interior of the Cayman models will therefore make you feel right at home. Here, everything is focused on one goal: advancing with a blend of sport and comfort. The driver is optimally integrated into the vehicle. The ascending centre console positions the gear lever close to the steering wheel for fast, sporty and ergonomic gearshifts. The individual controls are clearly organised. All buttons and the functions of the on-board computer are intuitive to find and select. The instrument cluster, with central rev counter and 4.6-inch colour screen

provides you with all the information you need.

The sporty character of the Cayman is further reinforced by the Sports seats – fitted as standard and with seat centres in Alcantara. Materials have been carefully chosen to ensure the exquisite and stylish integration in the interior design. The visible effect is exemplified by the silver-coloured details on the dashboard and centre console and by leather appliqué on selected features, such as the steering wheel rim, gear lever/selector and door handle inlays. In the Cayman S, the door armrests and the storage compartment lid on the centre console are also finished in leather as standard.

The Cayman GTS is even sportier. Together with the standard leather interior in black, Alcantara is used in the doors, the dashboard lower section, the centre console, the roof lining and the A-pillars. As well as in the seat centres of the Sports seats Plus, which also have the 'GTS' logo embroidered on the headrests. Another striking feature is the standard SportDesign steering wheel which, like the gear lever/selector, is also finished in Alcantara.

For the Cayman GTS, the GTS interior package is also available as an option, enabling you to emphasise its sports performance with the colours Carmine Red or Rhodium Silver.

Still not enough? Then why not make use of the wide range of personalisation options available for the Cayman models, a selection of which is featured on the following pages.

¹ Cayman S with leather interior in Platinum Grey, Porsche Doppelkupplung (PDK) and other optional equipment



Leather package.

The optional leather package enhances the interior of your Cayman or Cayman S with additional items finished in leather.

You can choose between a minimalist single-tone interior, with one of the standard colours Black, Platinum Grey, Luxor Beige or Yachting Blue; and a two-tone combination of Agate Grey and Pebble Grey, Agate Grey and Lime Gold or Agate Grey and Amber Orange. With these

combinations, the features in leather (on the seats, only the seat centre) are finished in the contrasting colour.

The package adds a leather finish to the instrument surround, centre console storage compartment lid, seat centres,

side bolsters and headrests, door armrests and door pulls. With the leather package, the door pulls feature a silver-coloured trim strip, which accentuates the dynamic and sweeping design of the interior.

GTS interior package.

Even clearer, even more direct, even sportier. The optional GTS interior package for the Cayman GTS lends noticeably more emphasis to the interior space by supplementing the standard

Cayman GTS interior in black with sporty highlights in Carmine Red or Rhodium Silver. For instance, the 'GTS' logo embroidered on the headrests in a contrasting colour. The rev counter dial, various decorative seams, the 'PORSCHE'

logo on the floor mats and the edges of the seat belts are also a contrasting colour. The progressive sporty impression is consistently continued with carbon, which is used on the dashboard trim strip, the doors and on the centre console.

1 Leather package in Agate Grey and Amber Orange
2 GTS interior package in Carmine Red





Steering wheels.

Do you have a clear idea of where you are going? To ensure you steer a precise course, the different steering wheels available for the Cayman models are mechanically adjustable and feature a high-grip rim in smooth-finish leather. For the Cayman GTS, Alcantara, a material developed for motorsport, is used.

In combination with the optional fully electric seats, the steering wheel is also electrically adjustable and, for even more convenience, a memory function is included.

Sports steering wheel.

The three-spoke sports steering wheel is fitted as standard in the Cayman and Cayman S. In conjunction with optional Porsche Doppelkupplung (PDK), it features two ergonomic switches.

In conjunction with the Sport Chrono Package and PDK options, there is an additional display above the airbag module which tells you whether the SPORT, SPORT PLUS and Launch Control functions are activated.

The multifunction steering wheel, which is available on request, provides extra convenience with four buttons and two

thumbwheels for easy operation of many audio, telephone and navigation functions.

SportDesign steering wheel.

The SportDesign steering wheel is distinguished from the standard steering wheel by its twin-spoke design. It is available on request for the Cayman and Cayman S and is fitted as standard in the Cayman GTS. In conjunction with PDK it features two light-alloy gearshift paddles ergonomically located between the left- and right-hand steering wheel spokes.

When combined with the Sport Chrono Package and PDK, the steering wheel has an additional display in the left- and right-

hand spokes to indicate whether the SPORT, SPORT PLUS and Launch Control functions are activated.

Steering wheel heating.

For extra comfort on those cold days, a heating function is available as an option for the sports steering wheel and the multifunction steering wheel.

- 1 SportDesign steering wheel in Alcantara
- 2 Sports steering wheel
- 3 Multifunction steering wheel in conjunction with PDK
- 4 SportDesign steering wheel with gearshift paddles in conjunction with Porsche Doppelkupplung (PDK)



Support you can rely on: a prerequisite to following your own road.

Seats.

Sports seats.

The sports seats fitted as standard in the Cayman and Cayman S are comfortable and provide support even when the car is driven hard into corners. The seats are equipped with electric backrest adjustment and manual height and fore/aft adjustment. The seat centres are finished in Alcantara.

Fully electric Sports seats.

You don't have to sacrifice comfort. The optional fully electric Sports seats enable the fully electric adjustment of seat height, backrest angle, squab angle and squab depth. The fore/aft adjustment, four-way lumbar support and even the steering column are also electrically operated. The included memory package stores a range of settings for both

exterior mirrors and all driver's seat and steering wheel positions.

Sports seats Plus.

Sports seats Plus, upholstered in smooth-finish leather, are available as an option for the Cayman and Cayman S. They are fitted as standard in the Cayman GTS – including seat centres in Alcantara. The side bolsters of the seat squab and backrest are more prominently defined and have a firmer, more sporty padding for even better lateral support. To help you find the optimum posture, the seats feature electric backrest adjustment and manual height and fore/aft adjustment.

Adaptive Sports seats Plus.

For a stronger connection between sport and comfort, adaptive Sports seats Plus

are available on request. These are an enhanced version of the Sports seats Plus with the added functionality of the fully electric Sports seats and adjustment of the side bolsters on the squab and backrest.

Sports bucket seats.*

Sports bucket seats are available as an option and feature a folding backrest, integrated thorax airbag and manual fore/aft adjustment. The carbon surface finish conceals a seat shell in glass-/carbon-fibre reinforced plastic.

Seat heating and ventilation.

Seat heating is available as an option for all seats. Seats are heated in the squab, backrest and side bolsters. In conjunction with seat heating, we can equip the seats

(excluding Sports bucket seats and seats with centres in Alcantara) with seat ventilation on request. A slipstream effect is produced by active ventilation of the perforated seat centre and backrest and by passive aeration at the side bolsters. This evaporates perspiration moisture and therefore makes for a dry and pleasant seating environment, even in hot weather.

Child seats.

A Cayman should be enjoyed by passengers of all ages. ISOFIX child seat preparation is available as an option and includes a deactivation function for the passenger airbag.

- 1 Standard Sports seat
- 2 Fully electric Sports seat
- 3 Sports seat Plus
- 4 Adaptive Sports seat Plus
- 5 Sports bucket seat
- 6 Sports bucket seat in conjunction with the GTS interior package

* Child seats are not compatible with the Sports bucket seats.



**Its most important feature:
freedom of choice.**

Storage compartments.

You could escape from everyday life or you could fully embrace it. The choice is yours. It's also a little example of the personal freedom that the Cayman models afford you – not only with performance, but also with everyday practicality. The lockable glove

compartment and the compartment with a power socket under the armrest in the centre console provide plenty of space. Other storage features include two compartments in each door, a net in the passenger footwell, clothes hooks on the backs of the seats and two practical cupholders above the glove compartment.

Front luggage compartment.

Increased storage space is another facet of your personal freedom. The front luggage compartment has a capacity of 150 litres and is lined with black carpet.

Rear luggage space.

The rear luggage space is both convenient and functional. Comprising the shelf above the engine cover and the luggage compartment behind, it comfortably holds even long items of luggage such as sports equipment. A total capacity around 275 litres is

available. As part of the interior, it is lined with carpet in the interior colour. The luggage protection bar and inlay are made of brushed aluminium. Concealed by the inlay are the service openings for the coolant and engine oil tanks. Storage compartments in the upper luggage compartment provide additional space for

your belongings. The Porsche Driver's Selection catalogue contains a selection of matching luggage accessories.



**You can live without everyday practicalities.
Comfort and convenience? Never.**

Additional comfort and convenience features.

Two-zone automatic climate control.

As an option to the standard air conditioning system you can have two-zone automatic climate control with separate temperature controls for the driver and passenger. Three different air conditioning modes can be set.

Light design package.

The optional light design package comprises dimmable LEDs in the overhead console, in the door storage compartments and in the footwells. LED illumination of the front luggage compartment and in the vanity mirrors of the sun visors is also included with the light design package. The rear luggage

space and C-pillars already have LED lights as standard.

HomeLink® (programmable garage door opener).

The optional programmable garage door opener is integrated into the overhead console and remotely controls up to three different garage doors, gates, home lighting and/or alarm systems.

'Welcome Home' lighting.

The 'Welcome Home' lighting function automatically switches on the LED daytime running lights for a user-defined period whenever the vehicle is opened or closed using the key remote.

Anti-theft protection.

The Cayman models are equipped as standard with an immobiliser with in-key transponder. The Cayman S and Cayman GTS have an alarm system with contact-sensitive exterior protection. A radar-based interior surveillance system protects the interior of the vehicle and also comes combined with an alarm system for extra security.

Porsche Vehicle Tracking System (PVTS).

This preparation enables the future installation of the Porsche Vehicle Tracking System (PVTS) available from Porsche Tequipment. The system makes

it possible to locate a stolen vehicle across most of the countries of Europe. The preparation package includes a special wiring loom and a tilt sensor for the alarm system.

1 Cayman S with leather interior package in Platinum Grey, SportDesign steering wheel, Porsche Doppelkupplung (PDK) and other optional equipment



Cruise control.

Optional cruise control helps you stay within the speed limit; it also helps you to save fuel by maintaining a constant speed.

Adaptive cruise control including Porsche Active Safe (PAS).

Also available as an option in conjunction with Porsche Doppelkupplung (PDK) is the enhanced version of cruise control, which regulates the speed of your vehicle in line with the speed of the vehicle in front. A radar sensor scans the road ahead up to a distance of 200 m.

You have selected a cruising speed but have begun to gain on the vehicle in front because it is driving more slowly – this is detected by the radar sensor. The system now reduces the speed of your vehicle by restricting throttle or by gently applying the brakes until your chosen distance from the vehicle in front is maintained. If the vehicle ahead slows further, adaptive

cruise control will decelerate your vehicle accordingly – even down to a halt.

For increased safety, the system also readies the brakes whenever it detects that the distance from the vehicle is decreasing. However, the driver should be prepared to intervene manually if heavier braking is required. As soon as the road

ahead clears, your vehicle will accelerate back up to the cruising speed originally set.

Porsche Active Safe (PAS) issues an audible and a visual warning if the system detects that your vehicle is approaching the vehicle in front too quickly. This is accompanied by a brief application of brake force and, where necessary, the

initiation of targeted braking. During this process, any braking by the driver is boosted to achieve the maximum braking force that the system is able to provide.

- 1 Cruise control
- 2 Adaptive cruise control



1



2



Speed limit indicator.

The optional speed limit indicator informs you about speed limits, overtaking restrictions and when they are lifted, as recorded by a camera near the rear-view mirror. The information is displayed on the colour screen in the instrument cluster or the optional Porsche Communication

Management (PCM). If a traffic sign is not identified, for example in heavy rain or when it is dark, the speed limit stored in the navigation module will be automatically displayed. The advantage for you is that you can give your full concentration to the traffic.

ParkAssist.

An enhanced version of ParkAssist also provides monitoring of the area to the front of the vehicle. Ultrasonic sensors are neatly integrated into the front and rear aprons. The audible alert is supplemented by a visual warning in the central display of the CDR audio system,

optional CDR Plus or optional PCM, which shows a graphical representation of the vehicle from overhead.

Reversing camera.

Comfort even when reversing. The optional reversing camera uses a camera

image and dynamic guidelines to help you with precise parking and manoeuvring.

Porsche Entry & Drive.

With the optional Porsche Entry & Drive, you can keep your car key in your pocket. Because the door or the luggage compartment lid unlocks as soon as you

take hold of the door handle or put your hand close to the front or rear panel. The vehicle is started and stopped with the electric ignition switch.

1 Speed limit indicator



Want to set the tone? Go ahead.

Audio and communication.

CDR audio system.

The standard CDR audio system with 7-inch touchscreen has simple, intuitive controls. It includes a CD radio – a six-disc CD autochanger is available as an option – with an FM twin tuner with RDS, 30 memory presets, dynamic autostore and speed-sensitive volume control. And four loudspeakers with a total output of 2 x 25 watts. The AUX interface in the glove compartment can be used to connect an external audio device such as a compatible MP3 player.

CDR Plus audio system.

The CDR Plus audio system, with nine loudspeakers and a total output of 235 watts, is available as an option. An analogue and digital twin tuner ensures an extensive selection of radio broadcasts. Functions are controlled using a high-

resolution 7-inch touchscreen. Other features include a CD/DVD drive, a USB port and an AUX interface. A six-disc CD/DVD autochanger is available on request.

Porsche Communication Management (PCM) including navigation module.

The optional PCM is your central information and communication system. It is powerful and multifunctional, yet easy to operate.

The main feature is the intuitive 7-inch touchscreen. The CD/DVD drive is MP3-compatible. A six-disc CD/DVD autochanger integrated into the PCM is available as an option. With the universal audio interface in the glove compartment, you can store up to 5,000 MP3 music files on the 40-GB internal hard drive. Alternatively, you can connect and even

charge your iPod® or any other audio source. The device can be operated conveniently and safely via PCM, the optional multifunction steering wheel or the optional voice control system. The USB socket can also be used to download data from the performance display of the Sport Chrono Package, as well as data from the electronic logbook.

The navigation module of PCM with high-speed hard drive allows you to choose between a 2D display and a 3D perspective. In some regions, terrain as well as buildings can be displayed in 3D with satellite image overlay. Split screen mode enables you to view two functions at once, such as the current navigation map and a list of symbols that represent the next navigation instruction. The navigation module calculates the routes

dynamically in response to official traffic messages (TMC) and information from traffic flow sensors (TMC Pro*).

Electronic logbook.

An electronic logbook is available for PCM as an option. The automatically recorded data can be analysed on your home PC. The software supplied fulfils all statutory requirements for automatic logbooks as specified by the German revenue authorities.

1 CDR audio system
2 Porsche Communication Management (PCM)

* TMC Pro is currently available in Germany, Austria and Switzerland.





TV tuner.*

The optional TV tuner for PCM is capable of receiving unencrypted analogue and digital television broadcasts (DVB-T) to provide entertainment between journeys. For your safety, the TV picture is switched off while the car is in motion.

Voice control system.

To get what you want, you like to get straight to the point. Almost all of the functions of PCM can be controlled using the optional voice control system with word-by-word input.

Telephone module and mobile phone preparation.*

The optional quadband GSM telephone module offers convenience and excellent reception. By inserting a SIM card directly

into the integral SIM card reader of CDR Plus or PCM, calls can be made using the hands-free facility. For even more convenience, the Bluetooth® capability of a mobile phone can be used to make calls via the SIM Access Profile (SAP).

Once automatic pairing is complete, the mobile phone's aerial is switched off to conserve battery charge and the phone operates via the car aerial. Depending on the mobile phone model, this gives access not only to the numbers on the SIM card, but also to the phone's internal memory.

Depending on the phone, it can also be controlled using CDR Plus or PCM, the optional multifunction steering wheel or the optional voice control system, without

it ever leaving your pocket. The telephone module also enables you to establish a Bluetooth® link with those mobile phones that only support the Handsfree Profile (HFP). In this case, the GSM connection is always established through the aerial of the mobile phone. CDR Plus or PCM acts as a hands-free system and you can leave the mobile phone tucked away.

There is a Bluetooth® handset available on request for the telephone module. It is stored in the centre console and features a display and keypad.

Bluetooth® mobile phone connection is also available separately with mobile phone preparation.

- 1 Electronic logbook
- 2 TV tuner
- 3, 4 Voice control system
- * See notes on page 119.

Online services.*

With the free-to-download Aha Radio app, you can play web radio, news feeds, podcasts and audiobooks directly on PCM. It is also possible to call up local information such as the weather. Point of Interest searches with subsequent direct selection as your navigation destination are also supported. Online content is received by your smartphone and controlled by means of PCM.

Digital radio.*

This option enables you to receive digital radio broadcasts in the DAB, DAB+ and DMB audio formats, which offer far superior sound quality. Automatic changeover between digital and analogue ensures optimum reception of the selected station. Reception is dependent on local digital network availability.

1 Cayman GTS with Porsche Communication Management (PCM) and other optional equipment

* See notes on page 119.





1

Sound Package Plus.

For sophisticated ears, the optional Sound Package Plus, with a total output of 235 watts, creates an enhanced sound experience with no fewer than nine loudspeakers. Audio settings are entered using the CDR audio system, the optional CDR Plus audio system, or the optional Porsche Communication Management (PCM).

BOSE® Surround Sound System.

The optional BOSE® Surround Sound System really strikes a chord.

It comprises eight amplifier channels with a total output of 445 watts. Its 10 loudspeakers, including an active subwoofer integrated into the vehicle bodyshell behind the dashboard, deliver a balanced acoustic pattern.

In combination with the optional CDR Plus audio system or optional PCM, the BOSE® Surround Sound System enables

audio playback of DVDs and is thus able to make full use of the impressive sound spectrum of 5.1 digital recordings. Of course, you can still play other audio sources, such as CDs and MP3s, in stereo or, at the push of a button, in one of the virtual surround modes generated by BOSE® Centerpoint® 2.

The BOSE®-patented AudioPilot® noise compensation technology uses a microphone to continuously measure the ambient noise inside the vehicle and adapts music playback instantly and

automatically so that a consistent sound is maintained – whatever the driving conditions.

The result is a balanced, faithfully reproduced sound and a captivating 360° acoustic experience.

1 BOSE® Surround Sound System

Burmester® High-End Surround Sound System.

Any car manufacturer can integrate a sound system into a vehicle. Why not go one step further and embed the driver in a sound system? That was the aspiration for Porsche and Burmester® in the development of the optional Burmester® High-End Surround Sound System. Conceived and tuned specifically for the Cayman, this is high-end technology 'made in Germany'.

Components used in the car are as sophisticated as the components that Burmester® puts into its high-end home audio systems. How do the numbers sound? 12 amplifier channels with a total output of 821 watts and 12 loudspeakers including an active subwoofer. A particularly special feature is the integration of the active subwoofer into the bodyshell. Not only does this provide ideal conditions for the sound, it is consistent with the principles of lightweight construction as applied in motorsport.

Conceptually, we have broken entirely new ground. The analogue and digital filters of the crossover technology used have been optimally defined for their installation location, and finely tuned following extensive in-car audio testing. The perfect interaction of all loudspeakers and chassis delivers superior bass foundation, definition and impulse accuracy.

As yet unequalled, the result is a natural and richly textured spatial sound, even at top volume. All of this is achieved despite the system's remarkably low overall weight thanks to intelligent Burmester® lightweight technology. The pure, sporty design makes it clear that the appeal of the Burmester® High-End Surround Sound System is as much about the visual as it is the audio. Typically Porsche.

1-3 Burmester® High-End Surround Sound System





Knowing exactly what you want. That's how sports cars are made.
Just like your Cayman. **Personalisation.**

**The Cayman submits to nothing.
Except perhaps your imagination.**

Personalisation.

Those who pursue their own direction also want to shape it to their liking. With the comprehensive range of customisation options available for the Cayman, you can configure it to your personal preference before you place your order.

The following pages feature all the available options. For your ease of reference, each one has been arranged into the appropriate category – exterior or interior. For more information on the

options featured in this catalogue, please refer to the separate price list.

The extensive colour palette, for example, enables you to make your Cayman even more individual. It gives you the choice of four solid colours, eight metallic colours, three special colours and fourteen interior colours. With the GTS interior package, the Cayman GTS can also be enhanced with sporting contrasts in Carmine Red or Rhodium Silver.

Of course, you can choose to have your Cayman finished in virtually any other colour of your choice. For further information, please refer to the Porsche Exclusive Cayman catalogue. It offers an even more comprehensive selection of personalisation options for your Cayman and a way to turn something special into something unique.

With our Porsche Tequipment range of accessories, you can always customise

your Porsche at a later time. Please consult your Porsche Centre for more details.

Using the Porsche Car Configurator at www.porsche.com, you can transform your ideas into reality. Here, you can design your very own Cayman model from the ground up. The choice of colour and additional equipment, as always, is up to you.



Solid exterior colours.

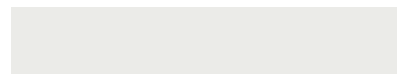

White



Racing Yellow



Guards Red



Black



Metallic exterior colours.

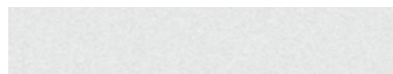

Carrara White Metallic¹⁾



Rhodium Silver Metallic



Sapphire Blue Metallic



Dark Blue Metallic



Mahogany Metallic



Anthracite Brown Metallic

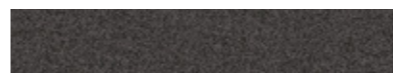

Agate Grey Metallic



Jet Black Metallic¹⁾



Special exterior colours.

GT Silver Metallic



Lime Gold Metallic

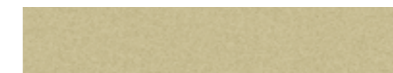



Carmine Red

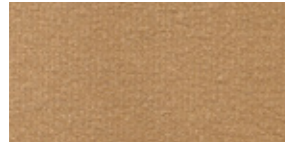

¹⁾ Not available until 06/2014.

Standard interior colours.

Leatherette/leather/soft-touch paint		
Interior colour.	Carpet.	Roof lining.
		
Black	Black	Black
		
Platinum Grey	Platinum Grey	Platinum Grey
		
Luxor Beige	Luxor Beige	Luxor Beige
		
Yachting Blue	Yachting Blue	Black

Leather package ¹⁾ (also available in standard colours)		
Interior colour.	Carpet.	Roof lining.
		
Agate Grey and Lime Gold	Agate Grey	Agate Grey
		
Agate Grey and Pebble Grey	Agate Grey	Agate Grey
		
Agate Grey and Amber Orange	Agate Grey	Agate Grey

See separate price list for recommended colour combinations.
¹⁾ In Lime Gold, Pebble Grey or Amber Orange leather; instrument shroud, door pulls, seat centres, door panel armrests and centre console main storage compartment lid.
²⁾ In Agate Grey or Black leather; dashboard including instrument shroud, steering wheel rim and airbag module, door panel upper sections and centre console. All other parts in a contrasting colour.

Two-tone combination²⁾, special colours and natural leather interior.

Leather in two-tone combination/soft-touch paint		
Interior colour.	Carpet.	Roof lining.
		
Black and Luxor Beige	Luxor Beige	Black
		
Agate Grey and Lime Gold	Lime Gold	Agate Grey
		
Agate Grey and Pebble Grey	Pebble Grey	Agate Grey
		
Agate Grey and Amber Orange	Amber Orange	Agate Grey

Leather in special colour/soft-touch paint

Interior colour.	Carpet.	Roof lining.
		
Agate Grey	Agate Grey	Agate Grey
Natural leather/soft-touch paint		
Interior colour.	Carpet.	Roof lining.
		
Espresso	Espresso	Espresso
		
Garnet Red	Garnet Red	Black



GTS interior package.^{3), 4)}

Leather/Alcantara/soft-touch paint

Interior colour.



Black and Carmine Red



Black and Rhodium Silver

Carpet/floor mats.

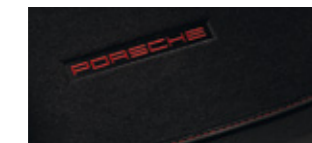

Black and Carmine Red



Black and Rhodium Silver

Roof lining.

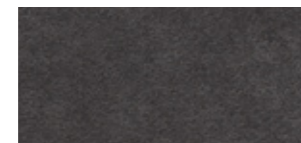

Alcantara

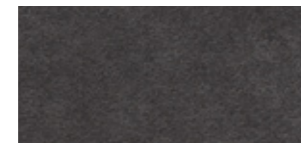

Alcantara

See separate price list for recommended colour combinations.

³⁾ Alcantara finish in conjunction with interior colour Black or GTS interior package: roof lining, A-pillars, dashboard lower section, seat centres, door armrests, door centre panel and door pulls, centre console storage compartment lid (partially), steering wheel and gear lever/selector.
Note: Alcantara finish not available in conjunction with any other colours. Interior colour Black optionally available without Alcantara trim.

⁴⁾ The following items with stitching in Carmine Red or Rhodium Silver: 'GTS' logo on headrests, 'PORSCHE' logo on floor mats, floor mat edging seams, leather interior seams. Additionally: dial face of rev counter and edges of seat belts in contrasting colour, with dashboard trims, door panels and centre console in carbon.



Side window trim strips in aluminium



Rear wiper

Option	Cayman	Cayman S	Cayman GTS	I no.	Page
Exterior.					
Metallic paint	<input type="radio"/>	<input type="radio"/>	<input type="radio"/>	Code	106
Special colours	<input type="radio"/>	<input type="radio"/>	<input type="radio"/>	Code	107
Colours to sample	<input type="radio"/>	<input type="radio"/>	<input type="radio"/>	Code	–
Side window trim strips in aluminium	<input type="radio"/>	<input type="radio"/>	<input type="radio"/>	559	112
Bi-Xenon headlights including Porsche Dynamic Light System (PDLS)	<input type="radio"/>	<input type="radio"/>	<input checked="" type="radio"/>	603	68
Bi-Xenon headlights including Porsche Dynamic Light System Plus (PDLS+)	<input type="radio"/>	<input type="radio"/>	<input type="radio"/>	632	69
Porsche Entry & Drive	<input type="radio"/>	<input type="radio"/>	<input type="radio"/>	625	91
Deletion of model designation	<input type="checkbox"/>	<input type="checkbox"/>	<input type="checkbox"/>	498	–
ParkAssist (rear)	<input type="radio"/>	<input type="radio"/>	<input type="radio"/>	635	90
ParkAssist (front and rear)	<input type="radio"/>	<input type="radio"/>	<input type="radio"/>	636	90
ParkAssist (front and rear) including reversing camera	<input type="radio"/>	<input type="radio"/>	<input type="radio"/>	638	90
Rear wiper	<input type="radio"/>	<input type="radio"/>	<input type="radio"/>	425	112
Electrically folding exterior mirrors with courtesy lighting	<input type="radio"/>	<input type="radio"/>	<input type="radio"/>	748	–
Automatically dimming mirrors with integrated rain sensor	<input type="radio"/>	<input type="radio"/>	<input type="radio"/>	P13	–

The vehicles illustrated in the chapter on personalisation may include additional options not featured in this catalogue. For information on these options, please consult your Porsche Centre. For more information on the options featured in this catalogue, please refer to the separate price list.

Option	Cayman	Cayman S	Cayman GTS	I no.	Page
Engine, transmission and chassis.					
Porsche Doppelkupplung (PDK)	<input type="radio"/>	<input type="radio"/>	<input type="radio"/>	250	41
Porsche Ceramic Composite Brake (PCCB)	<input type="radio"/>	<input type="radio"/>	<input type="radio"/>	450	52
Porsche Active Suspension Management (PASM)	<input type="radio"/>	<input type="radio"/>	<input checked="" type="radio"/>	475	47
Sports chassis (–20 mm)	<input type="radio"/>	<input type="radio"/>	<input type="checkbox"/>	X73	–
Porsche Torque Vectoring (PTV) including mechanically locking rear differential	<input type="radio"/>	<input type="radio"/>	<input type="radio"/>	220	56
Power steering Plus	<input type="radio"/>	<input type="radio"/>	<input type="radio"/>	658	49
Sport Chrono Package including dynamic gearbox mounts	<input type="radio"/>	<input type="radio"/>	<input checked="" type="radio"/>	639	59
Sports exhaust system	<input type="radio"/>	<input type="radio"/>	<input checked="" type="radio"/>	XLF	38

– not available I number/extra-cost option • standard equipment available at no extra cost



Porsche Ceramic Composite Brake (PCCB)



Sport Chrono stopwatch



18-inch Boxster wheel



19-inch Boxster S wheel



20-inch Carrera S wheel, painted in satin black



20-inch Carrera Classic wheel



20-inch 911 Turbo wheel



20-inch SportTechno wheel

Option

Wheels.

	Cayman	Cayman S	Cayman GTS	I no.	Page
18-inch Boxster wheels	<input type="radio"/>	-	-	395	114
19-inch Boxster S wheels	<input type="radio"/>	<input type="radio"/>	-	400	114
19-inch Cayman S wheels	<input type="radio"/>	•	-	406	50
20-inch Carrera S wheels	<input type="radio"/>	<input type="radio"/>	•	423	50, 114
20-inch Carrera Classic wheels	<input type="radio"/>	<input type="radio"/>	<input type="radio"/>	427	114
20-inch 911 Turbo wheels	<input type="radio"/>	<input type="radio"/>	<input type="radio"/>	429	114
20-inch SportTechno wheels including wheel centres with full-colour Porsche Crest	<input type="radio"/>	<input type="radio"/>	<input type="radio"/>	XRT	114
Wheels painted in satin black including wheel centres with full-colour Porsche Crest ^{1), 2)}	-	-	<input type="radio"/>	344	114
Wheel centres with full-colour Porsche Crest	<input type="radio"/>	<input type="radio"/>	<input type="radio"/>	446	114

The vehicles illustrated in the chapter on personalisation may include additional options not featured in this catalogue. For information on these options, please consult your Porsche Centre. For more information on the options featured in this catalogue, please refer to the separate price list.

Option

Interior.

	Cayman	Cayman S	Cayman GTS	I no.	Page
HomeLink® (programmable garage door opener)	<input type="radio"/>	<input type="radio"/>	<input type="radio"/>	608	86, 115
Cruise control	<input type="radio"/>	<input type="radio"/>	<input type="radio"/>	454	88
Adaptive cruise control including Porsche Active Safe (PAS)	<input type="radio"/>	<input type="radio"/>	<input type="radio"/>	456	88
Speed limit indicator	<input type="radio"/>	<input type="radio"/>	<input type="radio"/>	631	90
Two-zone automatic climate control	<input type="radio"/>	<input type="radio"/>	<input type="radio"/>	573	86
Light design package	<input type="radio"/>	<input type="radio"/>	<input type="radio"/>	630	86, 115

¹⁾ Only in conjunction with 20-inch Carrera S wheels.
²⁾ Available from 06/2014 at the earliest.

- not available I number/extra-cost option • standard equipment available at no extra cost



HomeLink®



Light design package



Smoking package



Floor mat

Option	Cayman	Cayman S	Cayman GTS	I no.	Page
Interior.					
Fully electric Sports seats (14-way, electric) with memory package including electric steering column adjustment	<input type="radio"/>	<input type="radio"/>	–	P06	82
Sports seats Plus (2-way, electric)	<input type="radio"/>	<input type="radio"/>	•	P04	82
Adaptive Sports seats Plus (18-way, electric) with memory package including electric steering column adjustment	<input type="radio"/>	<input type="radio"/>	<input type="radio"/>	P07	82
Sports bucket seats	<input type="radio"/>	<input type="radio"/>	<input type="radio"/>	P03	82
Seat heating	<input type="radio"/>	<input type="radio"/>	<input type="radio"/>	342	82
Seat ventilation	<input type="radio"/>	<input type="radio"/>	<input type="radio"/>	541	82
Steering wheel heating	<input type="radio"/>	<input type="radio"/>	<input type="radio"/>	345	81
Roof lining in Alcantara	<input type="radio"/>	<input type="radio"/>	•	594	111
Fire extinguisher	<input type="radio"/>	<input type="radio"/>	<input type="radio"/>	509	–
Smoking package	<input type="checkbox"/>	<input type="checkbox"/>	<input type="checkbox"/>	583	116
ISOFIX child seat preparation for passenger seat	<input type="radio"/>	<input type="radio"/>	<input type="radio"/>	899	82

The vehicles illustrated in the chapter on personalisation may include additional options not featured in this catalogue. For information on these options, please consult your Porsche Centre. For more information on the options featured in this catalogue, please refer to the separate price list.

Option	Cayman	Cayman S	Cayman GTS	I no.	Page
Interior.					
Partial leather seats	<input type="radio"/>	<input type="radio"/>	–	946	–
Leather package	<input type="radio"/>	<input type="radio"/>	–	980	78, 108
Leather interior package in standard colour	<input type="radio"/>	<input type="radio"/>	<input type="checkbox"/>	Code	108
Leather interior package in special colour	<input type="radio"/>	<input type="radio"/>	<input type="radio"/>	Code	109
Leather interior package in two-tone combination	<input type="radio"/>	<input type="radio"/>	<input type="radio"/>	970	109, 117
Leather interior package in natural leather	<input type="radio"/>	<input type="radio"/>	<input type="radio"/>	998	109
Leather interior package in colour to sample	<input type="radio"/>	<input type="radio"/>	–	Code	–
Brushed aluminium interior package in black ¹⁾	–	–	<input type="radio"/>	P2A	117
Brushed aluminium centre console trim in black ¹⁾	–	–	<input type="radio"/>	809	117
GTS interior package	–	–	<input type="radio"/>	088	79, 111
Multifunction steering wheel	<input type="radio"/>	<input type="radio"/>	<input type="radio"/>	844	81
SportDesign steering wheel	<input type="radio"/>	<input type="radio"/>	•	840	81

¹⁾ Available from 06/2014 at the earliest.

– not available I number/extra-cost option • standard equipment available at no extra cost



Leather interior package in two-tone combination



Cayman GTS with brushed aluminium interior package in black and brushed aluminium centre console trim in black



Porsche Communication Management (PCM)



Universal audio interface (USB)

Option	Cayman	Cayman S	Cayman GTS	I no.	Page
Audio and communication.					
CDR Plus audio system with digital radio, AUX and USB ports ^{1),5)}	<input type="checkbox"/>	<input type="checkbox"/>	<input type="checkbox"/>	P25	92
Porsche Communication Management (PCM) with navigation module, AUX and USB ports ^{1),5)}	<input type="checkbox"/>	<input type="checkbox"/>	<input type="checkbox"/>	P23	92, 118
Six-disc CD autochanger ^{1),2)}	<input type="checkbox"/>	<input type="checkbox"/>	<input type="checkbox"/>	692	92
Six-disc CD/DVD autochanger ^{1),3)}	<input type="checkbox"/>	<input type="checkbox"/>	<input type="checkbox"/>	693	92
Electronic logbook ⁴⁾	<input type="checkbox"/>	<input type="checkbox"/>	<input type="checkbox"/>	641	92
TV tuner ^{4),7)}	<input type="checkbox"/>	<input type="checkbox"/>	<input type="checkbox"/>	676	95
Voice control system ⁴⁾	<input type="checkbox"/>	<input type="checkbox"/>	<input type="checkbox"/>	671	95
Telephone module ^{3),6)}	<input type="checkbox"/>	<input type="checkbox"/>	<input type="checkbox"/>	666	95
Bluetooth® handset for telephone module ⁴⁾	<input type="checkbox"/>	<input type="checkbox"/>	<input type="checkbox"/>	669	95
Mobile phone preparation ⁵⁾	<input type="checkbox"/>	<input type="checkbox"/>	<input type="checkbox"/>	619	95
Online services ^{4),8)}	<input type="checkbox"/>	<input type="checkbox"/>	<input type="checkbox"/>	UN1	96
Digital radio ⁴⁾	<input type="checkbox"/>	<input type="checkbox"/>	<input type="checkbox"/>	691	96

Option	Cayman	Cayman S	Cayman GTS	I no.	Page
Audio and communication.					
Sound Package Plus	<input type="checkbox"/>	<input type="checkbox"/>	<input type="checkbox"/>	490	99
BOSE® Surround Sound System	<input type="checkbox"/>	<input type="checkbox"/>	<input type="checkbox"/>	680	99, 119
Burmester® High-End Surround Sound System	<input type="checkbox"/>	<input type="checkbox"/>	<input type="checkbox"/>	682	100, 119



BOSE® Surround Sound System



Burmester® High-End Surround Sound System

¹⁾ May be incompatible with some copy-protected audio CDs (CDR) or audio CDs/DVDs (CDR Plus, PCM).

²⁾ Only in conjunction with CDR.

³⁾ Only in conjunction with CDR Plus or PCM.

⁴⁾ Only in conjunction with PCM.

⁵⁾ For information on compatibility with iPod® and iPhone® models, please contact your Porsche Centre.

⁶⁾ The use of a mobile phone or telephone module in HFP mode: the use of a mobile phone inside a car may cause an increase in the interior electromagnetic field strength and, accordingly, in the electromagnetic radiation to which passengers are exposed. If a cradle is used to mount the mobile phone, the field strength in the passenger compartment can be reduced because the phone can be connected up to the external aerial (feature depends on how specific mobile phones connect to the cradle). For information about the availability of an upgrade kit for your mobile phone, please contact your accessories supplier.

The use of the telephone module for CDR Plus and/or PCM via a Bluetooth® SAP connection or with inserted SIM card prevents exposure to electromagnetic radiation as only the car's external aerial is ever used. Information on compatible mobile phones can be obtained from www.porsche.com or from your Porsche Centre.

⁷⁾ For receiving digital TV signals (DVB-T and MPEG-2 encoded signals) where available.

⁸⁾ Use of Aha Radio services with the optional telephone module with cordless handset requires activation of HFP mode in PCM.

The vehicles illustrated in the chapter on personalisation may include additional options not featured in this catalogue.

For information on these options, please consult your Porsche Centre.

For more information on the options featured in this catalogue, please refer to the separate price list.

– not available I number/extra-cost option • standard equipment available at no extra cost



Porsche Exclusive.

Would you like something even more individual?

That's just what we thought.

With the range of options featured in this catalogue, you can personalise your Porsche even further. Introducing

Porsche Exclusive. Have your vehicle individually and exclusively tailored to your wishes, even before it leaves the factory. Aesthetically and technically, inside and outside, using fine materials and with customary Porsche quality.

Our overriding principle? To ensure your car is uniquely handcrafted to your taste. You will find a wide range of design options in the separate Porsche Exclusive Cayman catalogue.

Either your Porsche Centre or the Customer Centre in Zuffenhausen (customercenter-exclusive@porsche.de or phone +49 (0)711 911-25977) will be happy to answer any questions about Porsche Exclusive that you may have.

Porsche Car Configurator.

The Cayman. Every curve offers great potential. So does a customised design.

Taste, personality and style. You decide how to refine the Cayman to your personal preference. With the Porsche Car Configurator, you can see the result instantly on your computer. Just four steps are all it takes to create your own Cayman. An interactive 3D tool enables you to see how the interior and exterior would look in the day or night.

Visit www.porsche.com to find the Porsche Car Configurator and discover much more about the fascination of Porsche.

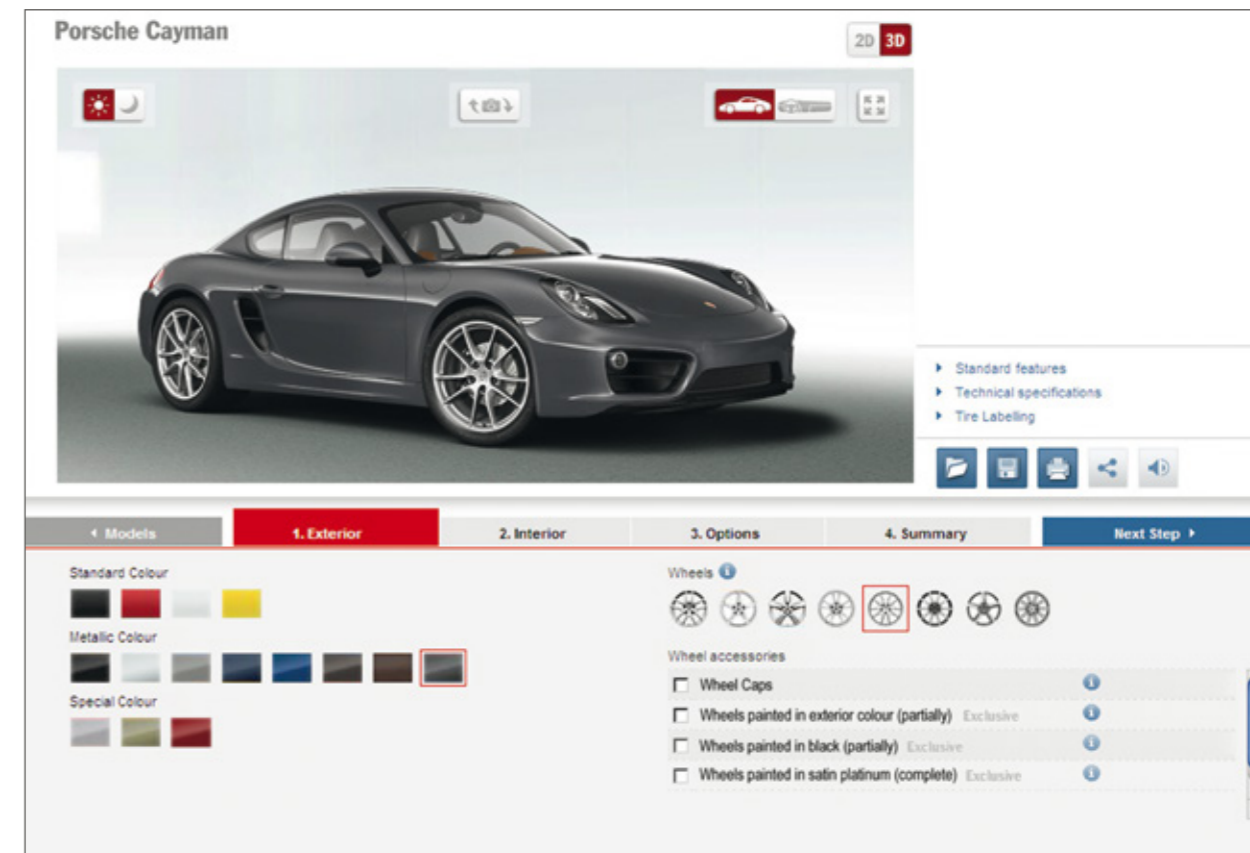

Porsche Driving Experience.

Porsche Sport Driving School.

At Porsche, we are working not only on the evolution of the sports car, but also on the development of the drivers. Safe driving on the road may be second nature, but what about mastering control of a sports car at the limits of sporty performance? We will help you to perfect your driving safety as well as your advanced skills and techniques step by step.

Under the supervision of our experienced Porsche instructors, in your own car or in one provided by the Porsche Sport Driving School, you can refine your ability on-road or off-road, on international racetracks or on ice or snow. We will be by your side from the start and, if it is your aim, we will accompany you through every training level on the way to obtaining your motorsport licence.

Porsche Travel Club.

With the Porsche Travel Club, your holiday begins from the very first second – the moment you step inside the vehicle. Leave everyday life behind and join us in some of the most beautiful regions in the world. We look forward to you being our guest. Whether you are here for several hours or several days, your constant companion will be a Porsche. A unique experience awaits and includes an exclusive hospitality package. You will

stay in first-class hotels and dine in the best restaurants your chosen route has to offer. The Porsche Travel Club gives you access to the very thing that words cannot describe: the authentic driving feel of a Porsche.

Visit www.porsche.com/drivingexperience and discover more about everything the Porsche Driving Experience has to offer.

Factory collection.

The first time that you drive your new Porsche will be a truly special moment. Nevertheless, you can make it even more special with Porsche factory collection. Come and collect your Porsche in Stuttgart-Zuffenhausen or Leipzig and be the one to take it to its rightful place: on the road.

Before this, we invite you behind the scenes of the Porsche production process. As part of a guided factory tour, you will see how much passion and precision goes into everything we do. You

can then take time to reflect on your experience over a leisurely lunch and look forward to the high point of the day: taking delivery of your Porsche. Our specialists will take their time to explain everything about your new car in as much detail as you wish.

That leaves you with just one more thing to decide: from which factory to collect your Porsche? Stuttgart-Zuffenhausen is steeped in tradition and history. Here, you can visit the Porsche Museum to

experience and learn about every aspect of the Porsche marque, with legendary models from a sports car history spanning over 60 years.

Or, if you would prefer your factory collection to be a little more on the sporty side, visit our production location in Leipzig. Your first driving experience will be a test drive in a Porsche model identical to the one you purchased and under the expert supervision of one of our instructors.

Hone your skills either on-road on the FIA-certified test circuit or on our very own off-road track in a Porsche off-road vehicle.

If you do opt for the factory collection, please contact your Porsche Centre to arrange a collection date. We will be happy to assist in the planning of your trip. You will also be given information on the formalities, legal or otherwise, to be completed before you can take delivery.





Porsche Centres

Your Porsche Centre can assist you with every aspect of purchasing and owning your Porsche. You will also find a wide range of products and services, including genuine Porsche parts and top-quality accessories.



Porsche Exclusive

Realise your vision of the perfect Porsche with our factory customisation programme. From styling enhancements to performance upgrades, all modifications are uniquely handcrafted for your Porsche.



Porsche Tequipment

Personalise your Porsche at any time after purchase with our range of aftermarket accessories. You will also find all our available products online at www.porsche.com/tequipment using the Tequipment accessories finder.



Porsche Driver's Selection

With products ranging from fashion and accessories to tailored luggage, this unique collection combines quality and style with everyday practicality.



Porsche Travel Club

Embark on a thrilling adventure and feel the power of Porsche. Stay in top-class hotels and dine in five-star restaurants. Worldwide. To find out more, call +49 (0)711 911-23360. E-mail: info@porschetravelclub.de



Porsche Sport Driving School

Develop your skill and explore your Porsche with the Porsche Sport Driving School. Learn about events at some of the world's most famous racing venues, call +49 (0)711 911-23364. E-mail: info@porscheporstdrivingsschool.de



Porsche Clubs

Since the first Porsche Club was founded in 1952, their number has grown to 640 with a total of 181,000 members worldwide. To find out more, go to www.porsche.com/clubs or call +49 (0)711 911-23252.

Porsche Service

Your expert partner for all current Porsche models as well as old and modern classics, whether your car needs servicing, routine care or special repairs.

Porsche Assistance

Enjoy peace of mind with our exclusive breakdown and accident recovery service. Membership is free when you buy a new Porsche.

Porsche Approved

So that our vehicles remain reliable and retain their value whether new or previously owned, all Porsche Approved cars meet the most stringent Porsche quality standards across the world. Each car is backed by the Porsche Approved warranty.

Porsche Financial Services

Our range of financial services is innovative and specially tailored to the needs of Porsche owners. Products range from attractive finance and leasing options to vehicle insurance and the Porsche Card.

Christophorus

Our bimonthly magazine for Porsche owners has news, interviews and a wide variety of features from throughout the world of Porsche.

Porsche Classic

Your specialist source for genuine Porsche parts as well as restoration services for all Porsche classics. Visit www.porsche.com/classic to find out more.

Porsche Museum

More than 80 vehicles at our headquarters in Stuttgart-Zuffenhausen await to take you on a journey through Porsche history. See icons such as the 356, 911 and 917 presented in an atmosphere you can't experience anywhere else.

Porsche Online

Go to www.porsche.com for all the latest news and information from Porsche.



You can obtain the latest brochures for Porsche Exclusive, Porsche Tequipment, Porsche Driver's Selection and Porsche Driving Experience from your Porsche Centre.



**True character is shown not on the straight and narrow.
But in the twists and turns.**

Summary.

You decide where your path leads. Just like the Cayman. With every left turn, with every right turn, around every corner, it embodies the code of the curve.

In its design, in its performance, in its handling. Characteristics that are proven in every new turn. So consistently that you can only think about one thing: the next one please.

The Cayman interprets the mid-engine concept more independently and in a more contemporary way than ever before.

The Cayman.

Technical data.

	Cayman	Cayman S
Engine		
Cylinders	6	6
Displacement	2,706 cm ³	3,436 cm ³
Max. power (DIN) at rpm	202 kW (275 hp) 7,400	239 kW (325 hp) 7,400
Max. torque at rpm	290 Nm 4,500–6,500	370 Nm 4,500–5,800
Compression ratio	12.5:1	12.5:1
Transmission		
Layout	Rear-wheel drive	Rear-wheel drive
Manual transmission	6-speed	6-speed
Porsche Doppelkupplung (PDK) (optional)	7-speed	7-speed
Chassis		
Front axle	Lightweight spring-strut suspension	Lightweight spring-strut suspension
Rear axle	Lightweight spring-strut suspension	Lightweight spring-strut suspension
Steering	Variable steering ratio, power-assisted (electromechanical)	Variable steering ratio, power-assisted (electromechanical)
Turning circle	10.98 m	10.98 m
Brakes	Four-piston aluminium monobloc fixed calipers, front and rear, discs internally vented and cross-drilled	Four-piston aluminium monobloc fixed calipers, front and rear, discs internally vented and cross-drilled
Vehicle stability system	Porsche Stability Management (PSM) with ASR, ABD, MSR and ABS 9.0	Porsche Stability Management (PSM) with ASR, ABD, MSR and ABS 9.0
Standard wheels	Front: 8 J x 18 ET 57, Rear: 9 J x 18 ET 47	Front: 8 J x 19 ET 57, Rear: 9.5 J x 19 ET 45
Standard tyres	Front: 235/45 ZR 18, Rear: 265/45 ZR 18	Front: 235/40 ZR 19, Rear: 265/40 ZR 19

¹⁾ With SPORT PLUS button activated.

²⁾ Weight is calculated in accordance with the relevant EC Directives and is valid for vehicles with standard specification only. Optional equipment increases this figure. The figure given includes 68 kg for the driver and 7 kg for luggage.

³⁾ Data determined in the NEDC (New European Driving Cycle) in accordance with the Euro 6 (715/2007/EC, 195/2013/EC and ECE-R 101.01) measurement method. The figures do not refer to an individual vehicle nor do they constitute part of the offer. They are intended solely as a means of comparing different types of vehicle. Fuel consumption calculated for vehicles with standard specification only. Actual consumption and performance may vary with items of optional equipment. Fuel consumption calculated for vehicles with standard specification only. A vehicle's fuel consumption and CO₂ emissions depend not only on its efficient use of fuel, but also on driving style and other non-technical factors. Current Porsche models with petrol engines are designed for fuel containing up to 10% ethanol. You can obtain further information about individual vehicles from your Porsche Centre.

	Cayman GTS
Engine	
Cylinders	6
Displacement	3,436 cm ³
Max. power (DIN) at rpm	250 kW (340 hp) 7,400
Max. torque at rpm	380 Nm 4,750–5,800
Compression ratio	12.5:1
Transmission	
Layout	Rear-wheel drive
Manual transmission	6-speed
Porsche Doppelkupplung (PDK) (optional)	7-speed
Chassis	
Front axle	Lightweight spring-strut suspension, regulated shock absorber system
Rear axle	Lightweight spring-strut suspension, regulated shock absorber system
Steering	Variable steering ratio, power-assisted (electromechanical)
Turning circle	10.98 m
Brakes	Four-piston aluminium monobloc fixed calipers, front and rear, discs internally vented and cross-drilled
Vehicle stability system	Porsche Stability Management (PSM) with ASR, ABD, MSR and ABS 9.0
Standard wheels	Front: 8 J x 20 ET 57, Rear: 9.5 J x 20 ET 45
Standard tyres	Front: 235/35 ZR 20, Rear: 265/35 ZR 20



	Cayman	Cayman S	Cayman GTS
Performance	Manual/PDK	Manual/PDK	Manual/PDK
Top speed	165 mph/164 mph	175 mph/174 mph	177 mph/175 mph
0–62 mph	5.7 secs/5.6 secs	5.0 secs/4.9 secs	4.9 secs/4.8 secs
Sport Chrono Package (with PDK) ¹⁾ 0–62 mph	–/5.4 secs	–/4.7 secs	–/4.6 secs
0–99 mph	12.9 secs/12.8 secs	10.8 secs/10.7 secs	10.6 secs/10.5 secs
Sport Chrono Package (with PDK) ¹⁾ 0–99 mph	–/12.5 secs	–/10.5 secs	–/10.3 secs
Flexibility (49–74 mph) in 5th gear	8.0 secs/–	6.5 secs/–	6.5 secs/–
Overtaking acceleration (49–74 mph)	–/3.6 secs	–/3.0 secs	–/2.9 secs
Unladen weight	Manual/PDK	Manual/PDK	Manual/PDK
(DIN)	1,330 kg/1,360 kg	1,340 kg/1,370 kg	1,345 kg/1,375 kg
Unladen weight (EC) ²⁾	1,405 kg/1,435 kg	1,415 kg/1,445 kg	1,420 kg/1,450 kg
Permissible gross weight	1,655 kg/1,685 kg	1,665 kg/1,695 kg	1,665 kg/1,695 kg
Dimensions/aerodynamics			
Length	4,380 mm	4,380 mm	4,404 mm
Width (including exterior mirrors)	1,801 mm (1,978 mm)	1,801 mm (1,978 mm)	1,801 mm (1,978 mm)
Height	1,294 mm	1,295 mm	1,284 mm
Wheelbase	2,475 mm	2,475 mm	2,475 mm
Luggage compartment volume (German Car Manufacturers' Assoc.) (front/rear)	150 litres/275 litres	150 litres/275 litres	150 litres/275 litres
Tank capacity (refill volume)	approx. 64 litres	approx. 64 litres	approx. 64 litres
Drag coefficient	0.30	0.30	0.31
Fuel consumption/emissions³⁾	Manual/PDK	Manual/PDK	Manual/PDK
Urban in mpg	23.9/25.9	22.2/24.8	22.2/24.8
Extra urban in mpg	44.1/45.6	39.8/44.8	39.8/44.8
Combined in mpg	33.6/35.8	31.4/34.4	31.4/34.4
CO ₂ emissions in g/km	195/183	211/190	211/190

Tyre identification.

Tyre type	Size	Fuel efficiency/ rolling resistance	Wet grip class	External rolling noise* (class)	External rolling noise (dB)
Summer tyres	235/45 ZR 18	E	C	(C) – (C)	69–68
	265/45 ZR 18	E	C–B	(C)	69
	235/40 ZR 19	E	B–A	(C) – (C)	71–68
	265/40 ZR 19	E	B–A	(C)	72–70
	235/35 ZR 20	F–E	C–A	(C)	72.3–71
	265/35 ZR 20	E	C–A	(C) – (C)	73.9–72

For logistical and technical reasons related to the production process, we are unable to accept orders for a particular make of tyre.

* (C) Quiet rolling noise, (C) Moderate rolling noise, (C) Loud rolling noise.



Index.

A	Cayman S	22	Engineered body design	64	Interior	15, 76, 108	
Adaptive cruise control including	Cayman GTS	26	Engines	32	Interior surveillance system	86	
Porsche Active Safe (PAS)	88	CD/DVD autochanger	92	Cayman engine	20	ISOFIX child seat preparation	82
Air conditioning system	86	CDR audio system	92	Cayman S engine	24		
Airbags	66	CDR Plus audio system	92	Cayman GTS engine	28	L	
Alarm system	86	Chassis	47	Environment	71	Leather package	78, 108
Anti-theft protection	86	Child seats	82	Exhaust system	38	Light design package	86
Audio and communication	92	Coasting	42	Exterior	12, 106	Lights	68
Audio interface, universal	92	Colours	106			Locking rear differential, mechanical	56
Auto start/stop function	36	Exterior	106	F		Logbook, electronic	92
Automatic climate control, two-zone	86	Interior	108	Factory collection	123	Luggage compartment	85
Automatic headlight activation	68	Comfort	76	Fuel	72		
		Cruise control	88	Fuel consumption	72, 130	M	
B						Manual transmission, six-speed	41
Bi-Xenon headlights	68	D		G		Materials	72
Bluetooth® handset		Design	12	Gearbox mounts, dynamic	60	Mechanically locking rear differential	56
for telephone module	95	Digital radio	96	GTS interior package	79, 111	Mobile phone preparation	95
BOSE® Surround Sound System	99	Direct fuel injection (DFI)	34			N	
Boxer engines	32	Dry-sump lubrication, integrated	34	H		Navigation module	92
Brakes	52	Dynamic gearbox mounts	60	HomeLink® (programmable garage door opener)	86		
Burmester® High-End Surround Sound System	100	E				O	
		Electric parking brake	52	I		Online services	96
C		Electrical system recuperation	37	Instruments	76		
Cayman concept	8	Emission control	71	Integrated dry-sump lubrication	34		
Cayman	18	Engine management	36				

P	Porsche Vehicle Tracking		SPORT PLUS button	59	W		
Panorama	124	System (PVTs)	86	Sports exhaust system	38	'Welcome Home' lighting	86
ParkAssist	90	Power steering Plus	49	Steering	49	Wheels	50, 114
Parking brake, electric	52			Steering wheel heating	81		
Personalisation	102	R		Steering wheels	81		
Porsche Active Suspension Management (PASM)	47	Rear wiper	112	Multifunction steering wheel	81		
Porsche Car Configurator	121	Recycling	72	SportDesign steering wheel	81		
Porsche Ceramic Composite Brake (PCCB)	52	Reversing camera	90	Sports steering wheel	81		
Porsche Communication Management (PCM)	92			Storage options	84		
Porsche Doppelkupplung (PDK)	41	S					
Porsche Driving Experience System (PDLs)	68	Safety	64	T			
Porsche Dynamic Light System (PDLs+)	69	Seat heating	82	Technical data	128		
Porsche Entry & Drive	91	Seat ventilation	82	Telephone module	95		
Porsche Exclusive	120	Seats	82	Thermal management	34		
Porsche Side Impact Protection System (POSIP)	66	Adaptive Sports seats Plus	82	Transmission	41		
Porsche Stability Management (PSM)	55	Child seats	82	TV tuner	95		
Porsche Torque Vectoring (PTV)	56	Fully electric Sports seats	82	Tyre identification	131		
		Sports bucket seats	82	Tyre pressure monitoring (TPM)	50		
		Sports seats	82				
		Sports seats Plus	82	U			
		Servicing	72	Universal audio interface	92		
		Smoking package	116				
		Sound Package Plus	99	V			
		Speed limit indicator	90	VarioCam Plus	34		
		SPORT button	36	Voice control system	95		
		Sport Chrono Package	59				

