



PORSCHE



The Boxster
Spirit, declared





Contents

Independence	6	Porsche Exclusive	122
Boxster concept	8		
Design	10	Porsche Car Configurator	123
Boxster	18		
Boxster S	22	Porsche Driving Experience	124
Boxster GTS	26		
		Factory collection	125
Forward thrust	30		
Engine	32	Panorama	126
Transmission	40		
Chassis	46	Principle	128
The wider view	62	Technical data	132
Safety	64		
Environment	70	Index	136
Free space	74		
Interior and comfort	76		
Audio and communication	94		
Free style	104		
Personalisation	106		

Independence





**For some things in life,
there will never be an app.**

The Boxster concept.

Spending time in the virtual world can be great fun. The only thing is, you can't feel the wind against your skin as you accelerate through every twist and turn. The Boxster celebrates real life. Whether it is known as a design classic, a powerful mid-engined sports car or a pure-bred roadster – it does full justice to its famous predecessors, such as the 356/1 or the 550 Spyder.

We were faced with the question of how it could do so in the future. As ever, the answer was to be found in the harmonious blending of style with functionality and of tradition with innovation. But what is harmony? Something quaint? Something soft and delicate? Not for us.

This is why we have refined our idea of what a roadster should be and honed and sharpened it to give it a completely new expression.

We achieved this with more performance – with more efficiency. With innovative technologies and intelligent lightweight construction. With a sporty exterior and interior with aesthetically appealing lines and curves in all the right places.

The spirit of the pure-bred roadster is very much alive and kicking. More independent than ever before, it is even more powerful, visceral and intense.

For fuel consumption, CO₂ emissions and efficiency class please refer to page 134.





Sometimes, spontaneity takes years of work.

Exterior design.

We have redefined the Boxster in terms of its performance, and defined how the roadster of the future should look. In doing so, we have once again succeeded in creating an icon of independence. Just like its legendary predecessors, including the 550 Spyder, it is a Porsche that continues to epitomise the feeling of genuine freedom.

The vertical contour of the headlights has been taken from Porsche race cars of the 1960s and 1970s – and brought into the future. Large, imposing air intakes lend the front a powerful appearance. The side contour promises one thing: thrilling performance.

The long wheelbase, the low, raked windscreen and the extremely sleek roofline when the roof is closed are integral to forming the stretched, wedge-shaped silhouette. Large wheels, up to 20 inches in size and a wide track add to the style. The distinctive wings give further emphasis. And, in combination

with the side air intakes, also highlight the mid-engine layout – reminiscent of the 718 RS 60 Spyder.

The dynamic contouring of the doors improves airflow to the side air intakes. At the top, it leads into a precise longitudinal edge and, at the bottom, it is underlined by the sculpted door sill.

Precise lines, which run elegantly across the wings to the rear are something special, even for a Porsche. Another feature of the rear is the rear wing, which deploys automatically at 120 km/h to reduce lift. When retracted, it makes a seamless transition to the LED taillights. For striking effect, the reversing light and rear fog

light are arranged in the middle underneath the rear wing.

Underneath, the stainless-steel tailpipe (dual-tube on the Boxster S and Boxster GTS) adds the finishing touch to the powerfully designed rear end.

In summary, the Boxster draws inspiration from a long history. Yet it also reflects a completely new interpretation of the roadster concept – with a clear focus on looking forward. Every muscle is defined and ready. Just waiting for the driver to get going.

**How much independence do we really have?
It's a question of inner attitude.**

Interior design.

The interior of the Boxster models delivers exactly what the exterior promises. Light, sleek and defined; everything is conceived with one goal in mind: the perfect drive.

The intelligent operating concept and the logical arrangement of the controls keep the driver's concentration purely on the road. The ascending centre console cocoons the driver perfectly and reduces the distance from the steering wheel to the gear lever for fast and ergonomic gearshifts. It's just one of the many principles that we've transferred from the racetrack to the road.

The door styling is similarly dynamic. The door pulls mirror the lines of the centre console and blend seamlessly into the distinctive design. The door storage compartments are sweeping and practical.

As you would expect from a sports car, the driver sits low down. Sports seats are fitted as standard in the Boxster and Boxster S, Sports seats Plus in the Boxster GTS.

The athletic proportions of the Boxster models made it possible to introduce a new interior architecture. The result is a feeling of space and light without

compromising the authentic roadster experience.

Are you ready to assert your independence? The ignition lock, as ever, is on the left. The three-spoke sports steering wheel falls perfectly to hand. As is typical of a Boxster, there are three round dashboard instruments to provide you with all the information you need.

In summary, the power, the contouring, the entire concept are all drawn in the direction of travel. In other words, the Boxster is serious. Serious fun.

1 Boxster S with natural leather interior in Garnet Red, SportDesign steering wheel and other optional equipment







Don't think about taking a step back. Unless it gives you a better run-up.

Boxster.

A roadster is not simply a car. The Boxster is not simply a roadster. It's a sports car that brings you closer to the road, closer to real life and connects you with your own free spirit.

The precise, lightweight chassis ensures an impressively dynamic drive, with practically no body roll or pitch. Or, in

short, a safer and more comfortable drive.

Power is transmitted to the road by 18-inch Boxster wheels. Their distinctive five-spoke design affords an unobstructed glimpse of the braking system's black four-piston aluminium monobloc fixed calipers. And you can keep an eye on the

pressure in all four tyres thanks to tyre pressure monitoring (TPM).

The large air inlets illustrate character. The sound produced by the central tailpipe in brushed stainless steel is unmistakably Porsche.

High-quality, stylish materials are used in the interior. The steering wheel rim, gear lever/selector and door pull inlays are finished in leather. The refined tone is enhanced by silver-coloured details, such as those found on the dashboard trim strip, the side and centre air vent surrounds and the centre console.

Lean, muscular and athletic, the car has inherited motorsport genes. They are characteristic of the Porsche family and vital to the irresistible appeal of the sports car. They are traits that make the Boxster the sports star among roadsters. Dynamic performance, whether the hood is open or closed, has become synonymous with driving pleasure.

Boxster engine.

Its 2.7-litre flat-six engine with direct fuel injection (DFI) and VarioCam Plus produces 195 kW (265 hp) at 6,700 rpm, and maximum torque of 280 Nm between 4,500 and 6,500 rpm. The top speed is 264 km/h. With the precisely geared six-speed gearbox fitted as standard, the Boxster accelerates from 0 to 100 km/h

in just 5.8 seconds. With the optional 7-speed Porsche Doppelkupplung (PDK), it races from 0 to 100 km/h in 5.7 seconds and achieves a top speed of 262 km/h. Together with PDK and the Launch Control feature of the optional Sport Chrono Package (p. 59), the Boxster can accelerate from 0 to 100 km/h in a mere 5.5 seconds.

For fuel consumption, CO₂ emissions and efficiency class please refer to page 134.

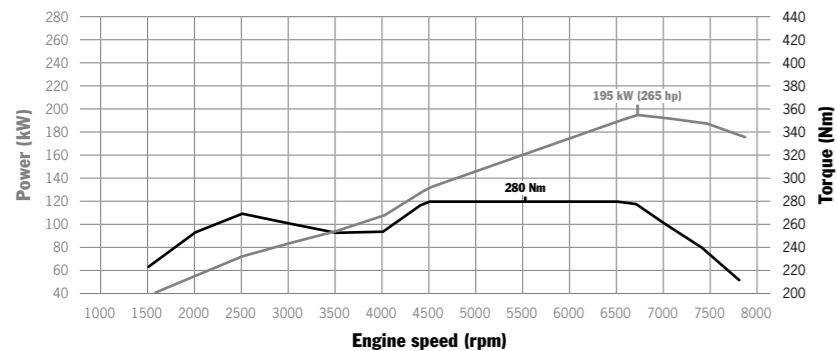

Boxster: 195 kW (265 hp) at 6,700 rpm, 280 Nm between 4,500 and 6,500 rpm





Why live on standby?

Boxster S.

Life cannot be lived intensely enough. Driving should be truly engaging. This is the core message of the Boxster S.

It stands for dynamic driving in its purest form. The lightweight chassis is an excellent match for the powerful engine.

Optional Porsche Active Suspension Management (PASM) and Porsche Torque Vectoring (PTV), also available as an option, offer increased agility and driving pleasure at the same time as improving traction and handling; enabling the Boxster S to deliver excitement at every twist and turn.

19-inch Boxster S light-alloy wheels with a double-spoke design are fitted as standard and create an exceptionally powerful presence for a roadster. The necessary safety is provided by the four-piston aluminium monobloc fixed-caliper brakes. The front brake discs are 15 mm larger than those on the Boxster and the brake calipers are finished in red. The

optional Porsche Ceramic Composite Brake (PCCB) provides motorsport braking performance.

The Boxster S comes with Bi-Xenon headlights as standard. The centrally positioned dual-tube twin tailpipe in brushed stainless steel sounds as impressive as it looks.

In the interior of the Boxster S, the door panel armrests and the storage compartment lid in the centre console are additionally upholstered in leather. The rev counter has an aluminium-coloured dial face.

The Boxster S is an even more vehement interpretation of the classic roadster. It has been engineered to provide an immediate, intense experience. Standby mode is not an option.

Boxster S engine.

Producing 232 kW (315 hp) at 6,700 rpm, the 3.4-litre flat-six engine with direct fuel injection (DFI) and VarioCam Plus delivers a mighty 37 kW (50 hp) and 80 Nm more than the engine in the Boxster. Maximum torque of 360 Nm is available from 4,500 to 5,800 rpm. The sprint from 0 to 100 km/h is completed in 5.1 seconds and a top speed of 279 km/h can be achieved.

Nevertheless, the dynamic performance of the Boxster S can be further enhanced. With the optional Porsche Doppelkupplung (PDK), the Boxster S reaches 100 km/h in 5.0 seconds and boasts a top speed of 277 km/h. The Launch Control feature of the optional Sport Chrono Package reduces the time to accelerate from 0 to 100 km/h to just 4.8 seconds.

For fuel consumption, CO₂ emissions and efficiency class please refer to page 134.

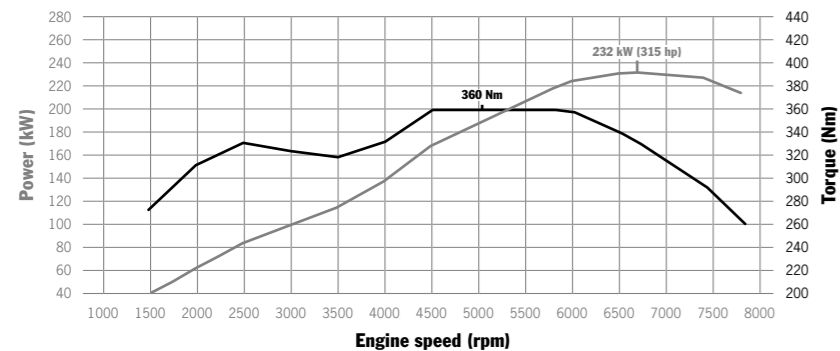

Boxster S: 232 kW (315 hp) at 6,700 rpm, 360 Nm between 4,500 and 5,800 rpm





If it's not open air, it's not real rock 'n' roll.

Boxster GTS.

Legends are experienced in the open air. Rock legends, racing legends. Legendary emotions that burn in our heart and get under our skin. We want more. But can it be any more intensive? The answer from our engineers has three letters: GTS.

Pure sports performance – even when stationary. Thanks to a redefined front with characteristic contouring and large

air inlets. An impression that is reinforced by the smoked LED daytime running lights and position lights that are exclusive to the GTS. Bi-Xenon headlights including Porsche Dynamic Light System (PDLS) are fitted as standard and are black on the inside. An extremely impressive feature are the 20-inch Carrera S wheels with their dynamic 10-spoke design.

Impressive dynamic performance. Thanks to the precise, lightweight adaptive suspension. Porsche Active Suspension Management (PASM) is standard. It adjusts the damping forces according to driving style and conditions. The suspension is also 10 mm lower than that of the Boxster S.

At the rear, the distinctive smoked taillights and the redesigned rear apron give added emphasis to the sports performance delivered by the Boxster GTS. The black 'Boxster GTS' logo lends a definite signature feature, while the unmistakable Porsche sound from the black, dual-tube sports tailpipe provides an acoustic one. Made even more vivid by the sports exhaust system.

The inside is just as impressive, offering a leather interior in minimalist black as standard. Together with additional Alcantara finishes on the standard SportDesign steering wheel and gear lever/selector, and on the lower section of the dashboard, the doors and the centre console. As well as in the centre of the Sports seats Plus, which also have the 'GTS' logo embroidered on the headrests.

The Boxster GTS. A design classic with a greater desire for freedom. A mid-engine sports car that gets under the skin. A roadster for the pure driving experience. Already a legend.

Boxster GTS engine.

The enhanced-performance 3.4-litre flat-six engine with direct fuel injection (DFI) and VarioCam Plus produces 243 kW (330 hp) at 6,700 rpm. That's 11 kW (15 hp) more than the Boxster S. Maximum torque of 370 Nm is available over the range from 4,500 to 5,800 rpm. A consistently lightweight construction ensures an extraordinary low power-to-weight ratio of just 5.5 kg/kW

(4.11 kg/hp). With the six-speed gearbox, the Boxster GTS accelerates from 0 to 100 km/h in a mere 5.0 seconds. The top speed is 281 km/h. Performance is enhanced even more by the optional Porsche Doppelkupplung (PDK), with which it sprints from 0 to 100 km/h in 4.9 seconds. And with the Launch Control function of the Sport Chrono Package, it breaks the 100 km/h mark in only 4.7 seconds.

For fuel consumption, CO₂ emissions and efficiency class please refer to page 134.

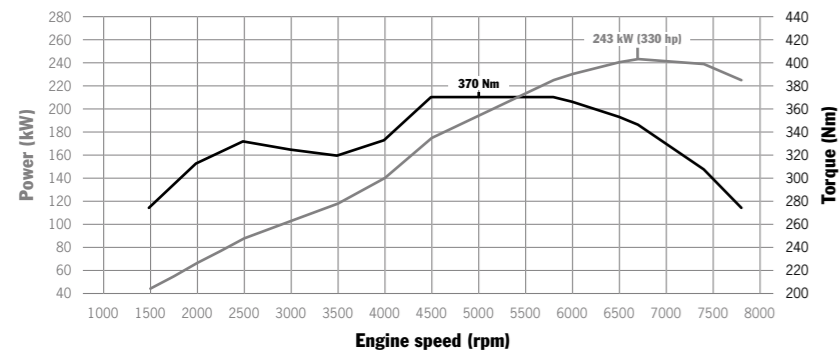

Boxster GTS: 243 kW (330 hp) at 6,700 rpm, 370 Nm between 4,500 and 5,800 rpm





Forward thrust

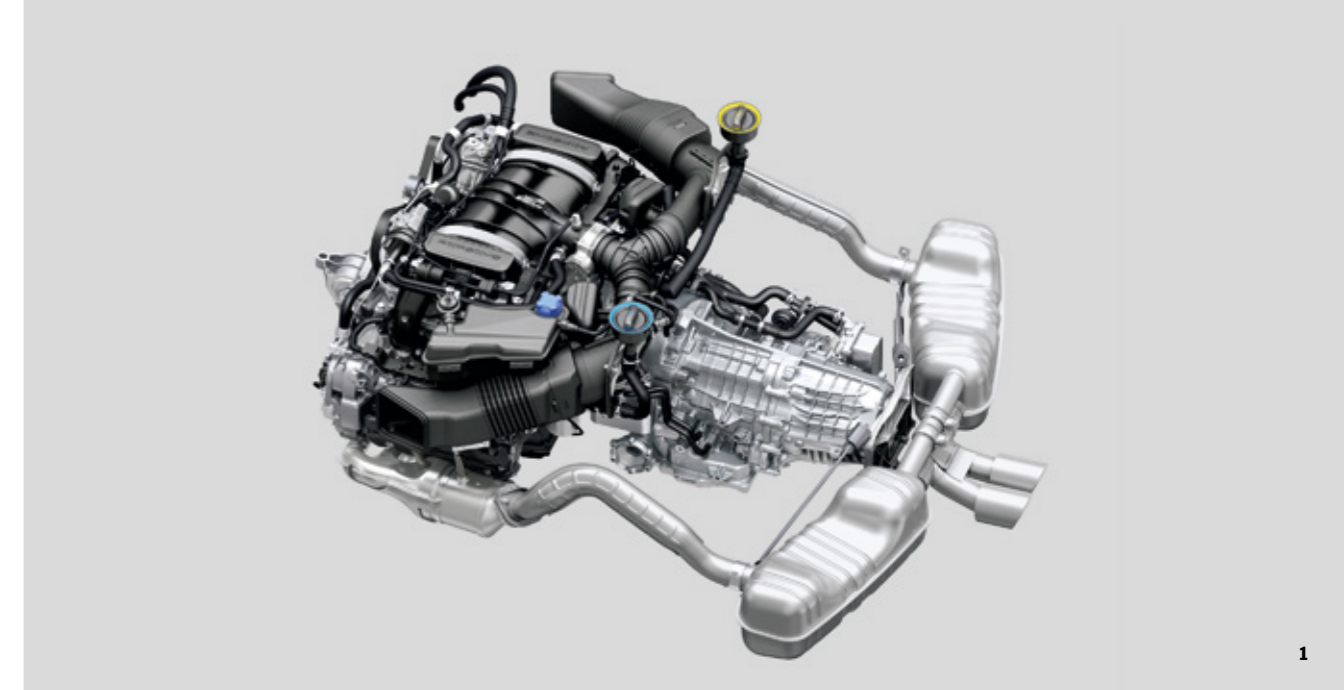

**Always mid-engined.
Never middle ground.**

Boxer engines.

At Porsche, the mid-mounted boxer engine is more than a tradition, it is a legend.

One of the most renowned examples of its use was in the 550 Spyder. In conjunction with an intelligent lightweight construction, this arrangement delivered

outstanding agility and cornering dynamics and proved to be a key factor in the countless victories achieved on some of the world's most famous racetracks.

In the 1960s, the 718 RS 60 Spyder contributed to the triumphant success of the mid-engined race car with wins in hillclimbing and endurance events.

In short: the mid-mounted engine belongs at Porsche and it belongs in the Boxster. The advantages speak for themselves. The centre of gravity is low and in the middle, with the weight uniformly distributed between the front and rear axles. This is reflected in the well-balanced handling characteristics and

excellent manoeuvrability, especially when cornering.

Combining the intrinsic values of high performance with comparatively low fuel consumption and emission figures. Made possible by racetrack engineering – for the road.

The engines are equipped with VarioCam Plus and direct fuel injection (DFI) as standard. As well as efficient technologies such as auto start/stop, electrical system recuperation and enhanced thermal management.

What else could we have given the mid-mounted engine? An even more agile response. One press of the SPORT button on the centre console makes engine performance even more dynamic for driving pleasure at the limits of performance.

1 Engine, gearbox and exhaust system in the Boxster S

For fuel consumption, CO₂ emissions and efficiency class please refer to page 134.



Direct fuel injection (DFI).

The Boxster models are equipped with direct fuel injection (DFI) as standard. Multi-hole injectors deliver fuel straight to the combustion chamber with millisecond precision. DFI also improves the internal cooling of the combustion chamber by having the mixture prepared directly in the cylinder. The higher compression ratio provides more power output at the same time as higher engine efficiency.

VarioCam Plus.

VarioCam Plus is a two-in-one engine concept for adjusting the intake camshafts and switching the lift of the intake valves. The system first

differentiates between driver inputs that typify normal, everyday driving and those inputs that demand maximum performance. The electronic engine management system then imperceptibly adapts valve operation to the prevailing conditions.

This results in instant acceleration and extremely smooth running with comparatively low fuel consumption.

Integrated dry-sump lubrication.

Integrated dry-sump lubrication ensures a reliable supply of oil, even when a sporty driving style is adopted and the vehicle is experiencing powerful lateral acceleration. It also has additional cooling functions.

The electronic oil pump, which is activated as and when required, also lowers fuel consumption, thus reducing emissions.

Thermal management.

Thanks to the selective heat flow control strategy and on-demand, gradual activation of the various cooling circuits, the engine and gearbox warm up to normal operating temperature more rapidly. The consequent reduction in friction also reduces fuel consumption and CO₂ emissions. During sporty driving, thermal management also acts to reduce temperatures so that a high level of performance is maintained.

For fuel consumption, CO₂ emissions and efficiency class please refer to page 134.



Engine management.

The electronic engine management system ensures optimum engine performance at all times. It regulates all engine-related functions and assemblies. The results are optimum power output and torque with comparatively low fuel consumption and emissions.

SPORT button.

The SPORT button on the centre console is fitted as standard. When selected, ‘Sport’ mode is activated to provide greater response and enhanced driving pleasure. Throttle response becomes even more direct, the rev-limiter is adjusted to a harder setting and engine dynamics are tuned for performance

driving. The auto start/stop function is also deactivated.

With the optional Porsche Doppelkupplung (PDK) transmission, the shift points are reconfigured to operate at higher engine speeds. Shift times are reduced and gearshifts become firmer and more immediate, while throttle-blip downshifts

are accompanied by an emotive engine sound. Coasting mode (p. 42) is deactivated automatically.

Auto start/stop function.

The auto start/stop function, integrated as standard in the Boxster models, switches off the engine when you stop, select neutral and release the clutch

pedal. In cars with Porsche Doppelkupplung (PDK), it is simply a case of applying and holding the brake. All audio and communication systems remain switched on.

The engine will restart as soon as you operate the clutch or, in cars with PDK,

release the brake. This fuel-saving innovation is designed primarily for use in towns or congested motorway traffic.

Electrical system recuperation.

Another efficiency-enhancing function in the Boxster models is electrical system recuperation. The vehicle battery is

recharged by the generator predominantly under braking. Thanks to this selective recharging, when you request full driving power the maximum possible output can be directed straight to the road.

1 SPORT button
2 Auto start/stop button

For fuel consumption, CO₂ emissions and efficiency class please refer to page 134.

Exhaust system.

In the Boxster models, each cylinder bank has its own stainless-steel exhaust tract. Integrated catalytic converters and four corresponding Lambda sensors are used to keep emissions low. Downstream of the respective rear silencers, the system converges into a connecting tube and a single (Boxster) or twin (Boxster S and Boxster GTS) tailpipe.

Sports exhaust system.

The switchable sports exhaust system with its distinctive dual-tube sports tailpipe is standard in the Boxster GTS and available as an option for the Boxster and Boxster S. Finished in black for the Boxster GTS. For an even more intensive sports car sound at the press of a button.

- 1 Standard tailpipe on the Boxster
- 2 Standard tailpipe on the Boxster S
- 3 Standard tailpipe on the Boxster GTS



For fuel consumption, CO₂ emissions and efficiency class please refer to page 134.



Act or relax as you please.

Transmission.

Six-speed manual transmission.

The Boxster models are equipped as standard with a lightweight six-speed manual transmission. Gearshifts are smooth and optimally adapted to the respective engine map. Shift throws are short and the gear lever is easy to operate. For a truly engaging driving experience. The upshift indicator located in the central round instrument helps reduce fuel consumption.

Porsche Doppelkupplung (PDK).

Available as an option for the Boxster models is 7-speed Porsche Doppelkupplung (PDK), featuring both manual and automatic modes. PDK offers extremely fast gear changes with no interruption in the flow of power, improved acceleration over the manual transmission, very short response times, reduced fuel consumption and a distinct increase in comfort.

The design of PDK is similar to two conventional gearboxes in one. The odd numbered gears are housed on one assembly and the even numbered gears on another, each having its own clutch. While one gear is engaged, PDK pre-selects the next gear based on driver input. When the next gear is requested, drive is switched from one clutch to the other in milliseconds, delivering gear changes with no loss of drive.

- 1 Gear lever for six-speed manual transmission
- 2 PDK gear selector
- 3 PDK gearshift switches on multifunction steering wheel

For fuel consumption, CO₂ emissions and efficiency class please refer to page 134.

With the SPORT button selected, the full advantages of PDK are brought into play: a more immediate response to throttle inputs, even shorter shift times and swift, throttle-blip downshifts on overrun and when braking – always accompanied by an emotive engine sound.

When combined with the optional Sport Chrono Package (standard in the Boxster GTS), gearshifts are sportier, shift times shorter. Other gearshift strategies are also available – for uncompromising driving enjoyment.

Coasting.

Available with Porsche Doppelkupplung (PDK), coasting enables you to save even more fuel where the situation allows. The engine is decoupled from the transmission to prevent deceleration caused by engine braking. The vehicle can then make optimum use of its momentum and coast for longer distances. This lowers fuel consumption noticeably. Without losing any comfort or sports performance.

For fuel consumption, CO₂ emissions and efficiency class please refer to page 134.





A love of freedom is no reason to lose self-control.

Chassis.

Even when you want to make a break from everyday life, you should still keep your feet on the ground.

The chassis of the Boxster models is an excellent match for the powerful engines. Axle components are made predominantly of aluminium, thus keeping the weight of the vehicle and its unsprung masses low. Resulting in impressive dynamic performance with practically no body roll or pitch, with a high level of comfort and safety and comparatively low fuel consumption.

The Boxster models have a wide track and a long wheelbase. This increases stability. The independent suspension features lightweight spring-strut axles with longitudinal and transverse links and, at the front, cross members that have been refined for optimum control.

What does this mean for you? More. More directional stability, precise steering and sporty handling, and an agility that turns each corner into an incomparable experience.

Porsche Active Suspension Management (PASM).

PASM is available as an option and is fitted as standard in the Boxster GTS. It is an electronic damping control system which actively and continuously regulates the damping force for each wheel according to the road conditions and driving style. In addition, the suspension is lowered by 10 mm.



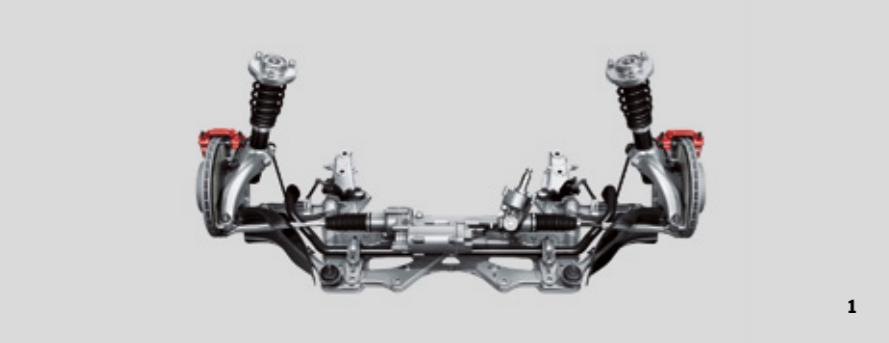

1



2



The system is always active in the background, ready to assist you automatically without having to be switched on. However, with the press of a button, you can adapt it to your preferred style of

driving. There are two different modes to choose from: 'Normal', which is a blend of performance and comfort, and 'Sport', where the setup is much firmer. Depending on the mode selected, therefore, PASM

can be either sportier or more comfortable than the standard chassis. The results are tangible: increased driving stability, enhanced driving pleasure and improved performance.

Steering.
The Boxster models have electro-mechanical steering. With a variable steering ratio, the steering system responds precisely, directly and more

efficiently, as you would expect from a Porsche. The electric motor uses energy only when the steering wheel is actually turned. And the absence of hydraulic fluid eliminates the need for servicing. Power

steering Plus, the optional speed-sensitive power steering system, ensures easier manoeuvring and parking, thus providing even greater comfort.

1 Front axle of the Boxster S
2 Rear axle of the Boxster S

Wheels and tyre pressure monitoring (TPM).

Performance calls for stability. The Boxster is therefore equipped with 18-inch alloy wheels as standard. The Boxster S has 19-inch wheels with a classic five-spoke design, ensuring firm contact between the vehicle and the road. The Boxster GTS emphasises its roadholding capacity with 20-inch Carrera S wheels with a dynamic 10-spoke design.

Or, if you prefer, you can choose alternative wheels which are available as options in sizes up to 20 inches.

Tyre pressure monitoring (TPM) is fitted as standard. It sends warnings to the on-board computer's display screen in the event of low tyre pressure. The screen in the instrument cluster enables the driver to check the pressure in all four tyres.

The system updates quickly and accurately after an engine start, tyre pressure correction or wheel change – for your safety and convenience.

- 1 18-inch Boxster wheel
- 2 19-inch Boxster S wheel
- 3 20-inch Carrera S wheel





Brakes.

Performance is reflected in excellent acceleration values. And we take account of both positive and negative acceleration. Which is why Porsche also traditionally sets standards for stopping power and stability. Braking power is a multiple of engine power.

The Boxster models are equipped with four-piston aluminium monobloc fixed-caliper brakes. This design means that, not only are the brakes extremely resistant to deformation, they are lightweight for a particularly fast and sensitive braking response. Even during continuous use. Brake cooling has also been optimised by the brake ventilation system with air spoilers at the front and rear axles.

The dynamics of the Boxster models also demand appropriate brake discs. These are internally vented and cross-drilled for improved braking in wet conditions. With a diameter of 330 mm, the front brake discs of the Boxster S and Boxster GTS are 15 mm larger than those of the Boxster. The diameter of the rear brake discs is 299 mm on all models.

Porsche Ceramic Composite Brake (PCCB).

The optional Porsche Ceramic Composite Brake (PCCB) has proven itself in motorsport. The cross-drilled brake discs have a diameter of 350 mm front and rear for even more formidable braking performance.

The use of six-piston aluminium monobloc fixed brake calipers on the front axle and four-piston units at the rear – all painted yellow – ensures extremely high brake forces which, crucially, are exceptionally consistent. PCCB enables shorter braking distances in even the toughest road and race conditions.

Another key advantage of PCCB is the extremely low weight of the ceramic brake discs, which are approximately 50 % lighter than standard discs of similar design and size. As well as enhancing performance and fuel economy, this also represents a major reduction in unsprung and rotating masses. The consequence of this is better roadholding and increased comfort, particularly on uneven roads.

In addition to the regular servicing work performed within the standard service intervals, additional servicing should be performed if used on the race track.

Electric parking brake.

The electric parking brake, which can be activated and deactivated manually, is released automatically as you pull away with your seat belt fastened. A hold function is integrated as standard. It assists you in making a comfortable, smooth and roll-free start on an incline.

- 1 Standard brake on the Boxster
- 2 Standard brake on the Boxster S and Boxster GTS
- 3 Porsche Ceramic Composite Brake (PCCB)



Porsche Stability Management (PSM).

Porsche Stability Management (PSM) is fitted as standard. This system automatically maintains stability, even at the limits of dynamic driving performance. Sensors continuously monitor the speed, yaw velocity and lateral acceleration of the car. Using this information, PSM is

able to calculate the actual direction of travel at any given moment. If the car begins to oversteer or understeer, PSM applies selective braking on individual wheels in order to restore stability.

When accelerating on wet or low-grip road surfaces, PSM improves traction –

as well as agility and safety – using the automatic brake differential (ABD) and anti-slip regulation (ASR). Integrated ABS is designed to minimise braking distances.

Prefer an ever sportier drive? PSM can be switched off. For your safety, however, PSM remains set to intervene if the

vehicle is braked and ABS assistance is required. ABS and ABD remain switched on at all times. Also included with PSM are engine drag torque control (EDC), precharging of the brake system and brake assist. If you suddenly release the accelerator pedal, PSM automatically prepares for your next action: the braking

system is precharged so that the brake pads are already in light contact with the brake discs. Maximum braking power is therefore achieved much sooner. Brake assist detects a panic braking situation and generates the brake pressure required for maximum deceleration.

In brief, PSM increases stability and safety – while providing the agility that you expect of a Porsche.

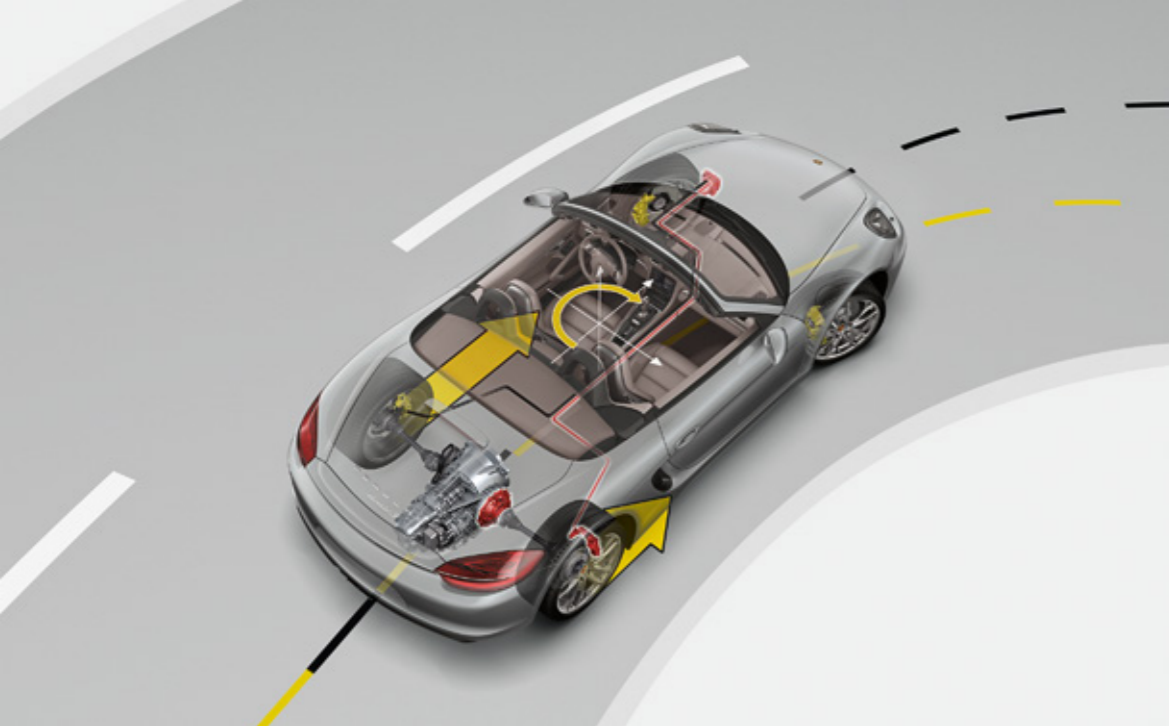

Porsche Torque Vectoring (PTV).

This optional system for increasing dynamic performance and stability varies the distribution of torque to the rear wheels and includes a mechanically locking rear differential. When the car is

driven assertively into a corner, moderate brake pressure is applied to the inside rear wheel, inducing an additional rotational pulse (yaw movement) around the vehicle's vertical axis.

This results in a direct and sporty steering action as the car enters the corner.

At low and medium vehicle speeds, PTV significantly increases agility and steering precision. At high speeds and when accelerating out of corners, the rear differential lock ensures greater driving

stability and traction on a range of surface conditions, including the wet and snow.

The results are remarkable stability, excellent traction, dynamic cornering at every speed, with precise steering and stable load transfer characteristics. And,

of course, lots of fun at every twist and turn – typical of the Boxster.



If you can take all the time in the world, why not take the best?

Sport Chrono Package.

Time is precious and every hundredth of a second counts. The Sport Chrono Package, available as an option for the Boxster and Boxster S and fitted as standard in the Boxster GTS, provides you with a priceless driving experience, thanks to an even sportier tuning of throttle response and handling characteristics.

The package comprises dynamic gearbox mounts, a performance display, a digital and analogue stopwatch and the SPORT PLUS button. When this is pressed, optional Porsche Active Suspension Management (PASM), fitted as standard in the Boxster GTS, switches to 'Sport' mode for harder damping and more direct

steering and therefore, even more intensive roadholding.

The trigger threshold for PSM is raised. Agility is perceptibly enhanced when braking for corners with PSM, allowing even sportier braking and exit acceleration. For increased dexterity, PSM can be set to standby while the car is still in SPORT PLUS mode. For safety, it is set to intervene automatically only when ABS assistance is required.

The throttle-blip function produces even sportier gearshifts. A managed burst of throttle ensures smooth load changes for increased stability and makes the

gearshift process an even more engaging experience.

In conjunction with the optional Porsche Doppelkupplung (PDK), the Sport Chrono Package comes with two additional functions for a sporty drive bordering on a motorsport experience. The first is 'Launch Control', which is designed to produce a racing start.

The second function is the motorsport-derived gearshift strategy. Using this, Porsche Doppelkupplung (PDK) is geared up for very short shift times and optimum shift points, while torque boosts during gear changes provide the maximum

acceleration available. This involving experience is further enhanced by overrun downshifts and the throttle-blip function for uncompromising driving pleasure.

An additional display in the steering wheel or instrument cluster shows when the SPORT buttons have been pressed and, with PDK, when Launch Control has been activated. In conjunction with the optional Porsche Communication Management (PCM), a special display enables you to view, store and evaluate lap times or other driving times. It shows the total driving time, lap distance, lap number and lap times recorded so far.

- 1 Sport Chrono display on sports steering wheel in conjunction with PDK
- 2 Sport Chrono stopwatch
- 3 SPORT and SPORT PLUS button

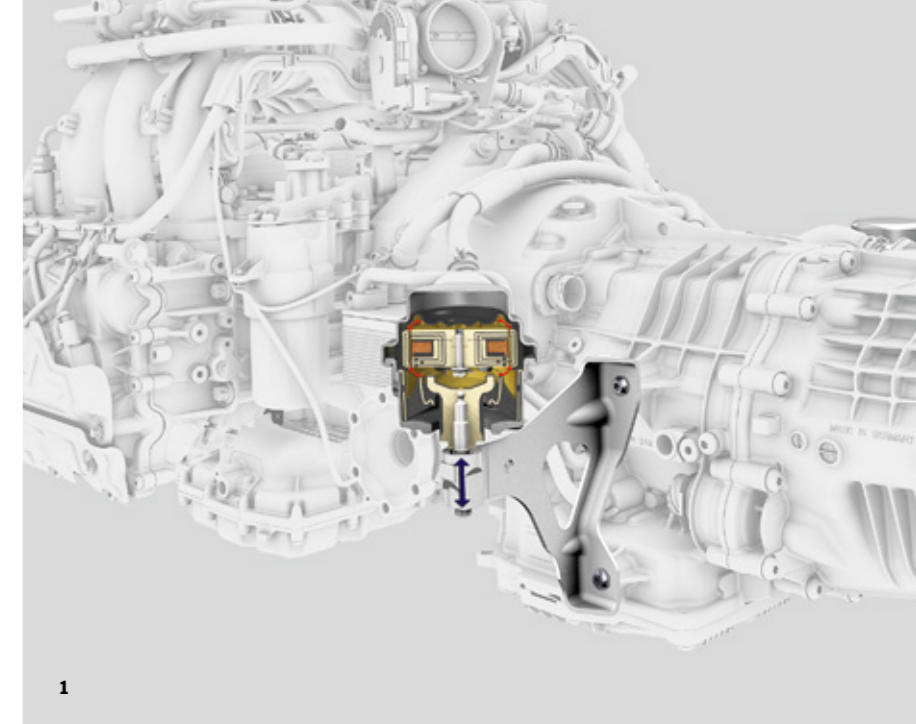

1

Dynamic gearbox mounts.

The Sport Chrono Package also includes dynamic gearbox mounts. The electronically controlled system minimises the oscillations and vibrations of the entire drivetrain, particularly the engine,

combining the advantages of hard and soft gearbox mounts.

Hard gearbox mounts are best for dynamic performance because they contribute towards greater driving precision. On the other hand, soft

gearbox mounts minimise oscillations and vibrations. This increases comfort on uneven roads, but at the expense of dynamic performance.

Dynamic gearbox mounts adapt their stiffness and damping performance to

driving style and road surface conditions. This is achieved using a fluid with magnetic properties and an electrically generated magnetic field. For you, this means that the gearbox mounts change according to the conditions. Under load change conditions and in fast corners,

handling is much more stable, while, with a more moderate driving style, comfort is increased thanks to the softer setting of the dynamic gearbox mounts.

This results in a thrilling sports performance when cornering – as well as a more comfortable ride.

With the SPORT or SPORT PLUS button you can switch the dynamic gearbox mounts from ‘Normal’ to ‘Sport’ or

‘Performance’ mode. In conjunction with the optional PCM, you can view the lateral and longitudinal forces as they act on the vehicle on the colour screen in the right-hand circular instrument.

1 Dynamic gearbox mounts



The wider view

**Be it at the office or on the road,
performance needs a stable concept.**

Safety.

On the road to independence, there is no room for the slightest element of doubt. The active and passive safety concept of the Boxster models is designed to ensure driving pleasure through peace of mind.

Safety is founded on a precisely engineered chassis and high-performance braking system. It also involves intelligent control systems, such as Porsche Stability Management (PSM), and depends on an innovative body construction designed to keep your roadster stable without diminishing its agility. It is enhanced by an ingenious lighting concept

featuring powerful headlights, by assistance systems that give you the information you need and by an interior that provides reliable protection in the event of an accident.

Engineered body design.

The bodyshell of the Boxster models is based on an intelligent lightweight body in aluminium and steel composite. The use of dissimilar but precisely combined components makes it possible to utilise specific material properties exactly where they are needed. Not only does this provide a high degree of safety for the

driver, it offers a considerable weight saving compared with the bodyshell of the previous model. This is why the doors, the luggage compartment lid and the rear hatch are made from lightweight aluminium.

The crumple zones in the front and rear aprons feature integral light-alloy bumpers, while impact absorbers offer additional safety. For the protection of occupants, energy-absorbing padding is used selectively in important areas within the passenger cell.



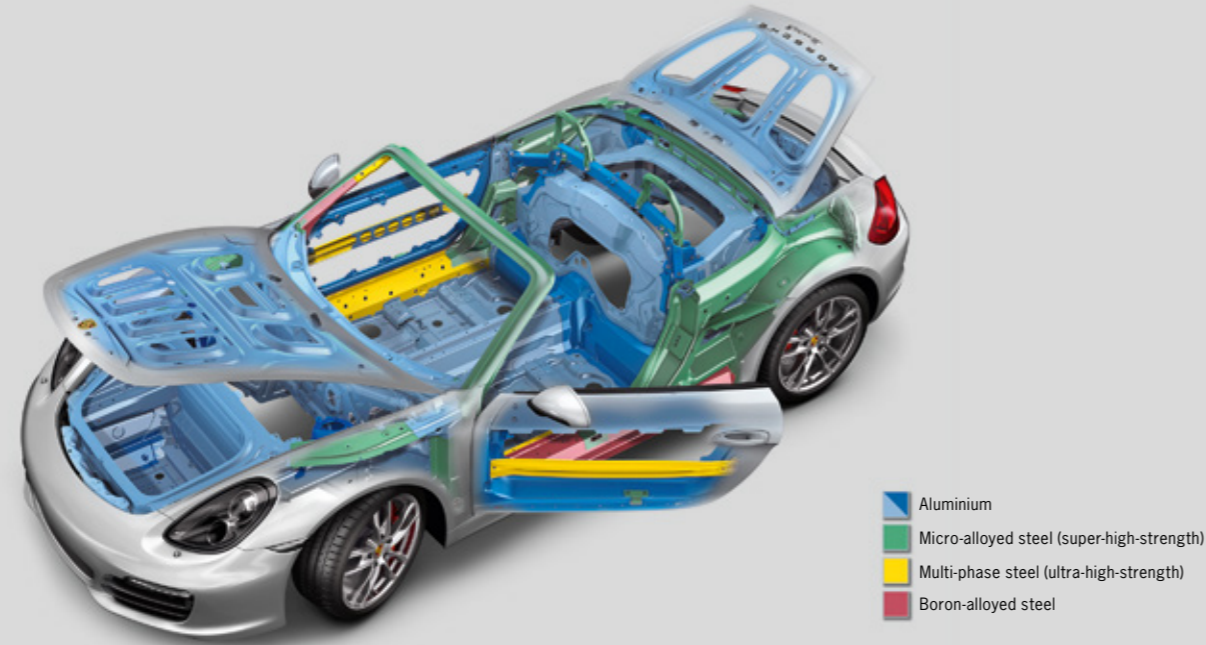

1

Roll-over protection.

Dual roll-over protection creates survival space in the event of a roll-over or side impact. The front roll-over protection element is made from super- and ultra-high-strength steels. The rear roll-over bars located behind the seats are a

composite construction of aluminium and steel. They are fully trimmed to blend in and provide an excellent level of safety. The upper seat belt guides are mounted on the roll-over bars for easier fastening.

Airbags.

To protect the driver and passenger, the Boxster models are equipped with full-size airbags, which are inflated in two stages depending on the severity and type of accident (e.g. frontal or offset frontal). In less serious accidents, the airbags are

only partially inflated, thereby minimising discomfort to the occupants.

In addition to the central airbag control unit on the transmission tunnel, a pair of impact sensors is located near the headlights. This allows a crash to be

2



detected and evaluated far sooner and with considerably greater accuracy.

Porsche Side Impact Protection System (POSIP).

The Boxster models are equipped as standard with the Porsche Side Impact Protection System (POSIP). It comprises

two side airbags on each side. An integral thorax airbag is located in the outer side bolster of each seat, while the door panels each contain an upwards-inflating head airbag. Each thorax airbag has a volume of 10 litres and each head airbag 15 litres, ensuring excellent protection in the event of a side impact, even with the

hood open. POSIP additionally includes steel side impact protection elements in the doors.

1 Engineered body design
2 Airbags and Porsche Side Impact Protection System (POSIP)



Lights.

Lights will always be an essential safety feature, but we go one step further by using them as part of an extraordinary styling concept.

Clear glass halogen headlights are fitted as standard on the Boxster. The Boxster S is equipped as standard with

Bi-Xenon headlights while the Boxster GTS has Bi-Xenon headlights including Porsche Dynamic Light System (PDLS). On all Boxster models, LED daytime running lights and position lights are integrated in the air inlets. All Boxster models are also equipped with automatic headlight activation as standard. This automatically switches between daytime running lights

and dipped beam based on ambient lighting conditions.

LEDs provide powerful illumination, respond rapidly to driver input and are more energy efficient with a longer service life. They are also used in the taillights, ensuring optimum safety and

creating a look that is unmistakable, day and night.

Bi-Xenon headlights including Porsche Dynamic Light System (PDLS).

Porsche Dynamic Light System (PDLS) is standard equipment in the Boxster GTS and available as an option for the other

Boxster models. Comprising Bi-Xenon main headlights with halogen main beam headlights, a headlight cleaning system and automatic dynamic range control, it provides uniform illumination of the road whether dipped or main beam is selected. The dynamic cornering light function swivels the main headlights towards the

inside of a bend based on the steering angle and road speed. In addition, PDLS adapts light distribution to suit your current driving speed. The adverse weather function is activated when the rear fog light is switched on. The result is increased safety – not least in corners and not only at night.

Porsche Dynamic Light System Plus (PDLS+).

The optional Porsche Dynamic Light System Plus (PDLS+) has an additional feature. Dynamic main beam control identifies the car in front as well as oncoming traffic and adapts the range of the light cone automatically to the

particular situation, switching smoothly between dipped and main beam.

- 1 Bi-Xenon headlights including PDLS
- 2 Direction indicator
- 3 Daytime running and position light
- 4 Night design at the front of the Boxster GTS
- 5 Night design at the rear of the Boxster GTS
- 6 Rear driving light
- 7 Brake light
- 8 Rear driving light and direction indicator



**You can live for the moment –
and still care about tomorrow.**

Environment.

If we are to continue to enjoy driving pleasure, we need to look after our environment. In other words, we need to take responsibility. In an era of intensifying debate about global climate change and CO₂ emissions, every automotive manufacturer is asking itself what it has to offer in terms of environmental protection. Our answer has long been the same: a combination of high power output and high efficiency.

Porsche has reduced fuel consumption across all model ranges by a double-digit percentage compared with the respective previous models, even though

performance has been increased in every generation. This is made possible by an efficient drive concept, e.g. with direct fuel injection (DFI) and VarioCam Plus, with lightweight construction, optimised aerodynamics and low rolling resistance.

The Environmental Management team at the Porsche Development Centre in Weissach aims to demonstrate a high level of environmental responsibility. Here, technological developments are carried out with environmental protection in mind. The goal is to enhance performance – but, where possible, not at the expense of the environment.

Exhaust emission control.

Vehicles manufactured by Porsche demonstrate that even high-performance sports cars can achieve moderate fuel consumption and exhaust emission values in their respective category.

This is achieved, on the one hand, by the use of fuel-efficient technologies such as direct fuel injection, VarioCam Plus, thermal management, electrical system recuperation, auto start/stop and, in conjunction with optional Porsche Doppelkupplung (PDK), coasting mode.

On the other hand, newly developed catalytic converters provide efficient emission control.

While the stereo Lambda control circuitry controls and monitors each cylinder bank separately. For each exhaust tract, Lambda sensors, together with the engine electronics and injectors, regulate the composition of the exhaust gas, while another Lambda sensor on each cylinder bank monitors pollutant conversion in the respective catalytic converter.

For fuel consumption, CO₂ emissions and efficiency class please refer to page 134.



Fuel economy and recycling.

Intelligent lightweight construction has been fundamental to the Porsche identity since 1948 for both technical and ecological reasons. This forms the basis for achieving low fuel consumption values in conjunction with outstanding performance.

On the technical side, various components are made with a high proportion of aluminium, magnesium, plastics and super-high-strength sheet steel. The materials used have been selected for their ability to withstand load, yet they are considerably lighter than conventional steel. As a result, the

bodyshell of the Boxster models has a light-alloy content of approximately 46%.

On the ecological side, all materials utilised are meticulously selected. We use only innovative and environmentally friendly components. All synthetic components are easily recyclable and

each material is labelled to facilitate its separation for recycling. The reduction in the number of plastic variants helps to ensure more efficient recycling. Recycled plastics are used where they meet our exacting technical requirements. In short, the Boxster is around 95% recoverable.

In addition, Porsche uses a high proportion of environmentally friendly water-based paints. For us, environmental protection does not begin at the end of a vehicle's life. It starts at the planning and development stage.

Fuel.

The Boxster models are designed to operate on fuels with an ethanol content of up to 10%. Ethanol has a positive impact on the CO₂ balance since the plants grown for the production of this biofuel also absorb CO₂ from the

atmosphere. The release of hydrocarbons from the fuel system has been minimised thanks to the active carbon filter and the multilayered material from which the fuel tank is made. All fuel lines are made from multilayered plastic, steel or aluminium.

Servicing.

Long service intervals offer clear advantages. For you, they reduce costs and save time. For the environment, they assist in the sparing use of consumables and replacement parts. For full details of service intervals, please refer to the separate price list.

For fuel consumption, CO₂ emissions and efficiency class please refer to page 134.

Free space



The most beautiful roof is the sky.

Interior and comfort.

Ultimately, the feeling of freedom comes from within. The interior of the Boxster models is purposefully designed as a declaration of independence.

The generously proportioned interior is light and offers plenty of space for driver and passenger comfort. The ascending centre console integrates the driver optimally into the vehicle by positioning the gear lever extremely close to the steering wheel to enable fast and sporty gear changes. The individual controls are arranged clearly and most functions are easy and intuitive to use. The instrument cluster, with central rev counter and 4.6-inch colour screen provides you with all the information you need.

The interior materials are high-quality as can be seen, for example, in the silver-coloured details on the dashboard and the centre console. And in the sporty, yet stylish leather trims. The steering wheel rim, gear lever/selector and door pull inlays are finished in leather thus creating a balanced blend of design and functionality which is typical of Porsche. In the Boxster S, the door armrests and the centre console storage compartment lid are also finished in leather.

The Boxster GTS is even sportier. Together with the standard leather interior in black, Alcantara is used in the doors, the lower section of the dashboard and in the centre console. As well as in the

centre of the Sports seats Plus, which also have the 'GTS' logo embroidered on the headrests. Another striking feature is the standard SportDesign steering wheel which, like the gear lever/selector, is also finished in Alcantara.

For the Boxster GTS, the GTS interior package is also available as an option, enabling you to emphasise its sports performance with the colours Carmine Red or Rhodium Silver. Still not enough for you? Then make use of the numerous options available in the Boxster model personalisation range. A selection of these can be found on the following pages.

1 Boxster S with natural leather interior in Garnet Red, Porsche Doppelkupplung (PDK) and other optional equipment, from the Porsche Exclusive range, for example





Leather package.

You may have thought the interior of your Boxster or Boxster S couldn't be any more stylish, but the optional leather package enhances its overall appeal by adding a leather finish to the instrument shroud, centre console storage

compartment lid, seat centres, side bolsters and headrests, the door armrests and door pulls. These feature a silver-coloured trim strip, which accentuates the dynamic and sweeping design of the interior.

You can choose between a minimalist single-tone interior, with one of the standard colours Black, Platinum Grey, Luxor Beige or Yachting Blue, and a two-tone combination of Agate Grey and Pebble Grey, Agate Grey and Lime Gold or Agate Grey and Amber Orange. The

features in leather (on the seats, only the seat centre) are finished in the contrasting colour.

1



GTS interior package.

It's good that we can even further enhance that sports car feel. The optional GTS interior package for the Boxster GTS gives noticeably more emphasis to the interior space by supplementing the standard Boxster GTS interior in black

with sporty highlights in Carmine Red or Rhodium Silver. For instance, the 'GTS' logo embroidered on the headrests in a contrasting colour. The rev counter dial, various decorative seams, the 'PORSCHE' logo on the floor mats and the edges of the seatbelts also feature a contrasting

colour. The progressive sporty impression is consistently continued with carbon, which is used on the dashboard trim strip, the doors and on the centre console.

1 Leather package in Agate Grey and Lime Gold
2 GTS interior package in Carmine Red

2



Steering wheels.

Where your journey takes you is in your hands. For this reason, the different steering wheels available for the Boxster models are mechanically adjustable and feature a high-grip rim in smooth-finish leather. Alcantara, a material developed for motorsport, is used in the Boxster GTS.

In combination with the optional fully electric seats, the steering wheel is also electrically adjustable, and for even more convenience, a memory function is included.

Sports steering wheel.

The three-spoke sports steering wheel is fitted as standard in the Boxster and Boxster S. In conjunction with the optional Porsche Doppelkupplung (PDK), it features two ergonomic switches.

With the Sport Chrono Package and PDK options, there is an additional display above the airbag module to tell you whether the SPORT, SPORT PLUS and Launch Control functions are activated.

The optional multifunction steering wheel provides extra comfort with the convenient operation of many audio, telephone and navigation functions.

SportDesign steering wheel.

A twin-spoke design distinguishes the SportDesign steering wheel from the standard steering wheel. Available as an option for the Boxster and Boxster S and standard in the Boxster GTS. In conjunction with PDK, it features two alloy gearshift paddles ergonomically located behind the right and left steering wheel spokes.

When combined with the Sport Chrono Package and PDK, the steering wheel has an additional display in the left- and right-hand spokes to indicate whether the SPORT, SPORT PLUS or Launch Control functions are activated.

Steering wheel heating.

For extra comfort on those chilly days, a heating function is available as an option for the sports steering wheel and the multifunction steering wheel. Cold weather should never be a reason to prevent you from enjoying your open-top driving experience.

- 1 SportDesign steering wheel in Alcantara
- 2 Sports steering wheel
- 3 Multifunction steering wheel
- 4 SportDesign steering wheel with gearshift paddles in conjunction with PDK



Take a seat and prepare your feet for action.

Seats.

Sports seats.

The Sports seats which are fitted as standard in the Boxster and Boxster S are comfortable and provide support even when the car is driven hard into corners. The seats have integrated electric backrest adjustment and manual height and fore/aft adjustment. The seat centres are finished in Alcantara.

Fully electric Sports seats.

You don't have to sacrifice comfort. The optional fully electric Sports seats offer the fully electric adjustment of seat height, backrest angle, squab angle and squab depth. Also electrically operated are the fore/aft adjustment, four-way lumbar support and even the steering column. The included memory package stores a range of settings, incorporating

both exterior mirrors and all the driver's seat and steering wheel positions.

Sports seats Plus.

Sports seats Plus, upholstered in smooth-finish leather, are available as an option for the Boxster and Boxster S. They are fitted as standard in the Boxster GTS – including seat centres in Alcantara. The side bolsters of the seat squab and backrest are more prominently defined and have a firmer, more sporty padding for even better lateral support. To help you find the optimum posture, the seats feature electric backrest adjustment and manual height and fore/aft adjustment.

Adaptive Sports seats Plus.

For a stronger connection between sport and comfort, adaptive Sports seats Plus

are available on request. These are an enhanced version of the Sports seats Plus with the added functionality of the fully electric Sports seats and adjustment of the side bolsters on the squab and backrest.

Sports bucket seats.*

Sports bucket seats are available as an option and feature a folding backrest, integrated thorax airbag and manual fore/aft adjustment. The carbon surface finish conceals a seat shell in glass/carbon-fibre reinforced plastic.

Seat heating and ventilation.

Seat heating is available as an option for all seats. Seats are heated in the squab, backrest and side bolsters. In conjunction with seat heating, we can equip the seats

(excluding Sports bucket seats and seats with centres in Alcantara) with seat ventilation on request. A slipstream effect is produced by the active ventilation of the perforated seat centre and backrest and by the passive aeration at the side bolsters. This evaporates perspiration moisture and therefore makes for a dry and pleasant seating environment, even in hot weather.

Child seats.*

The Boxster should be enjoyed by passengers of all ages. ISOFIX child seat preparation is available as an option and includes a deactivation function for the passenger airbag.

* Child seats are not compatible with Sports bucket seats.

- 1 Standard Sports seat
- 2 Fully electric Sports seat
- 3 Sports seat Plus
- 4 Adaptive Sports seat Plus with optional seat heating and seat ventilation
- 5 Sports bucket seat
- 6 Sports bucket seat in conjunction with the GTS interior package



1



2



3



4



5



6



Fully electric hood.

Think a sense of freedom isn't available at the push of a button? Think again. The Boxster models are equipped as standard with a fully electric hood. With the engine running, the opening and closing

processes are completed in around nine seconds. The hood is operable up to a speed of 50 km/h. When the vehicle is stationary, the hood can even be operated remotely using the vehicle key.

The hood design blends in elegantly with the contouring of the Boxster models. As a key design feature, it accentuates the stretched side view of the vehicle. The hood flows backwards and sweeps into

the body. The especially powerful silhouette promises excellent dynamic performance and delivers impressive aerodynamics.

The hood stows away compactly above the engine compartment without reducing the luggage compartment volume. The hood motor runs exceptionally quietly and the state-of-the-art soundproofing fabric is robust and improves interior acoustics.

The large rear screen is made from glass and is electrically heated and scratch-resistant, so you can continue to enjoy your freedom whatever the weather.

Wind deflector.

A wind deflector is fitted as standard in the Boxster S and Boxster GTS and is available as an option for the Boxster. It reduces air turbulence in the cabin and fits easily to the roll-over bar.

1 Wind deflector
2-4 Hood



**You have to create free space for yourself.
But sometimes it comes as part of the package.**

Storage compartments.

Ingenious storage solutions create plenty of space: the lockable glove compartment, the compartment with a power socket under the armrest in the rear centre console and the uncovered compartment to the front of it. In conjunction with the

smoking package, the uncovered compartment makes way for an ashtray with a lid. Other storage features include two compartments in each door, a net in the passenger footwell, clothes hooks on the backs of the seats and two practical cupholders above the glove compartment.

Two luggage compartments.

The two luggage compartments are further proof that the Boxster harmoniously combines the spirit of sport with everyday practicality. The front and rear compartments have a capacity of 150 and 130 litres, respectively, regardless

of whether the hood is up or down. The interior surfaces are carpet-lined and the lids are made from aluminium. The two service openings in the rear luggage compartment provide convenient access to the coolant and engine oil filler caps.

The separate Porsche Driver's Selection catalogue offers a range of matching luggage accessories.

- 1-3 Loading options with luggage items from the Porsche Driver's Selection range (items of luggage from the PTS AluFrame and PTS Soft Top series)
- 4 Door storage compartments
- 5 Uncovered centre console storage compartment
- 6 Cupholder

**Wave goodbye to everyday life.
But embrace everyday practicality.**

Additional comfort and convenience features.

Two-zone automatic climate control.

As an option to the standard air conditioning system you can have two-zone automatic climate control with separate temperature controls for driver and passenger. Three different air conditioning modes can be set.

Light design package.

The optional light design package comprises dimmable LEDs in the overhead console, in the area of the door handles, in the door storage compartments and in the footwells. LED illumination of the luggage compartments and in the vanity

mirrors of the sun visors is also included with the light design package.

HomeLink® (programmable garage door opener).

The optional programmable garage door opener is integrated into the overhead console and remotely controls up to three different garage doors, gates, home lighting and/or alarm systems.

‘Welcome Home’ lighting.

The ‘Welcome Home’ lighting function automatically switches on the LED daytime running lights for a user-defined

period whenever the vehicle is opened or closed using the key remote.

Anti-theft protection.

The Boxster models are equipped as standard with an immobiliser with in-key transponder. The Boxster S and Boxster GTS have an alarm system with contact-sensitive exterior protection. A radar-based interior surveillance system is available to protect the interior of the vehicle. A combined alarm and radar-based interior surveillance system is available as an option for the Boxster.

Porsche Vehicle Tracking System (PVTS).

Available as an option, this preparation enables the future installation of the Porsche Vehicle Tracking System (PVTS) available from Porsche Tequipment. The system makes it possible to locate a stolen vehicle across most of the countries of Europe. The preparation package includes a special wiring loom and a tilt sensor for the alarm system.

- 1 Air conditioning system (standard)
- 2 Two-zone automatic climate control





Cruise control.

Optional cruise control helps you stay within the speed limit, it also helps you to save fuel by maintaining a constant speed.

Adaptive cruise control including Porsche Active Safe (PAS).

Also available as an option in conjunction with Porsche Doppelkupplung (PDK) is the enhanced version of cruise control, which regulates the speed of your vehicle in line with the speed of the vehicle in front.

A radar sensor scans the road ahead up to a distance of 200 m.

You have selected a cruising speed but have begun to gain on the vehicle in front because it is driving more slowly – this is detected by the radar sensor. The system

now reduces the speed of your vehicle by restricting throttle or by gently applying the brakes until your chosen distance from the vehicle in front is maintained. If the vehicle ahead slows further, adaptive cruise control will decelerate your vehicle accordingly – even down to a halt.

For increased safety, the system also readies the brakes whenever it detects that the distance from the vehicle is decreasing. However, the driver should be prepared to intervene manually if heavier braking is required. As soon as the road ahead clears, your vehicle will accelerate

back up to the cruising speed originally set. Porsche Active Safe (PAS) issues an audible and a visual warning if the system detects that your vehicle is approaching the vehicle in front too quickly. This is accompanied by a brief application of brake force and, where necessary, the

initiation of targeted braking. During this process, any braking by the driver is boosted to achieve the maximum braking force that the system is able to provide.

- 1 Cruise control
- 2 Adaptive cruise control



Speed limit indicator.

The optional speed limit indicator informs you about speed limits, overtaking restrictions and when they are lifted, as recorded by a camera near the rear view mirror. The information is displayed on the colour screen in the instrument cluster or

the optional Porsche Communication Management (PCM). If a traffic sign is not identified, for example in heavy rain or when it is dark, the speed limit stored in the navigation module will be automatically displayed. The advantage for you is that

you can give your full concentration to the traffic.

ParkAssist.

Optional ParkAssist is activated the moment you select reverse gear. An audible signal gives a warning if you reverse too close to an obstacle.

An enhanced version of ParkAssist also provides monitoring of the area to the front of the vehicle. Ultrasonic sensors are neatly integrated into the front and rear aprons. The audible alert is supplemented by a visual warning in the central display of the CDR audio system, optional CDR Plus or optional PCM, which

shows a graphical representation of the vehicle from overhead.

Reversing camera.

Comfort, even when reversing. The optional reversing camera using a camera image and dynamic guidelines to help you with precise parking and manoeuvring.

Porsche Entry & Drive.

With the optional Porsche Entry & Drive, you can keep your car key in your pocket. Because the door or the luggage compartment lid unlocks as soon as you take hold of the door handle or put your hand close to the front or rear panel. The

vehicle is started and stopped with the electric ignition switch.

1 Speed limit indicator

**We've shown you what rock 'n' roll looks like.
Now you want to know how it sounds.**

Audio and communication.

CDR audio system.

The standard CDR audio system with 7-inch touchscreen has simple, intuitive controls. It has a CD radio – a six-disc CD autochanger is available as an option – including an FM twin tuner with RDS, 30 memory presets, dynamic autostore and speed-sensitive volume control. And four loudspeakers with a total output of 2 x 25 watts. The AUX interface in the glove compartment can be used to connect an external audio device such as a compatible MP3 player.

CDR Plus audio system.

The CDR Plus audio system, with seven loudspeakers and a total output of 185 watts, is available as an option. An

analogue and digital twin tuner ensures an extensive radio reception. Functions are controlled using a high-resolution 7-inch touchscreen. Other features include an MP3-compatible CD/DVD drive, a USB port and an AUX interface. A six-disc CD/DVD autochanger is available on request.

Porsche Communication Management (PCM) including navigation module.

The optional PCM is your central information and communication system. It is powerful and multifunctional, yet easy to operate.

The main feature is the intuitive 7-inch touchscreen. The CD/DVD drive is MP3 compatible. A six-disc CD/DVD

autochanger integrated in the PCM is available as an option.

With the universal audio interface in the glove compartment you can store up to 5,000 MP3 music files on the 40-GB internal hard drive. Alternatively, you can connect and even charge your iPod® or any other audio source. The device can be operated conveniently and safely via PCM, the optional multifunction steering wheel or the optional voice control system. The USB socket can also be used to download data from the performance display of the Sport Chrono Package, as well as data from the electronic logbook.

The navigation module of PCM with high-speed hard drive allows you to choose between a 2D display and a 3D perspective. In some regions, terrain as well as buildings can be displayed in 3D with satellite image overlay. Split screen mode enables you to view two functions at once, such as the current navigation map and a list of symbols that represent the next navigation instruction. The navigation module calculates the routes dynamically in response to official traffic messages (TMC) and information from traffic flow sensors (TMC Pro*).

* TMC Pro is available in Germany, Austria and Switzerland.

1, 3 Porsche Communication Management (PCM)
2 CDR audio system





Electronic logbook.

An electronic logbook is available for PCM as an option. The automatically recorded data can be analysed on your home PC. The software supplied fulfils all statutory requirements for automatic logbooks as specified by the German revenue authorities.

TV tuner.*

The optional TV tuner for PCM is capable of receiving unencrypted analogue and digital television broadcasts (DVB-T) to provide entertainment between journeys. For your safety, the TV picture is switched off while the car is in motion.

Voice control system.

You like to tell it straight. Almost all of the functions of PCM can be controlled using the optional voice control system with word-by-word input.

Telephone module and mobile phone preparation.*

The optional quadband GSM telephone module offers convenience and excellent reception. By inserting a SIM card directly into the integral SIM card reader of CDR Plus or PCM, calls can be made using the hands-free facility. For even more

convenience, the Bluetooth® capability of a mobile phone can be used to make calls via the SIM Access Profile (SAP). Once automatic pairing is complete, the mobile phone's aerial is switched off to conserve battery charge and the phone operates via the car aerial. Depending on the mobile phone model, this gives access

not only to the numbers on the SIM card, but also to the phone's internal memory. Depending on the phone, it can also be controlled using CDR Plus or PCM, the optional multifunction steering wheel or the optional voice control system, without it ever leaving your pocket.

The telephone module also enables you to establish a Bluetooth® link with those mobile phones that only support the Handsfree Profile (HFP). In this case, the GSM connection is always established through the aerial of the mobile phone. CDR Plus or PCM acts as a hands-free system and you can leave the mobile phone tucked away.

* Notes: see page 121.

- 1 Electronic logbook
- 2 TV tuner
- 3,4 Voice control system
- 5 Telephone module
- 6 Bluetooth® handset for telephone module



There is a Bluetooth® handset available on request for the telephone module. It is stored in the centre console and features a display and keypad.

Bluetooth® mobile phone connection is also available separately with mobile phone preparation.

Online services.*

With the free-to-download Aha Radio app, you can access radio, news feeds, podcasts and audiobooks directly with PCM. It is also possible to call up local information such as the weather. Point of Interest searches with subsequent direct selection as your navigation destination are also supported. Online content is received by your smartphone and controlled by means of PCM.

Digital radio.*

Digital radio broadcasts in the DAB, DAB+ and DMB audio formats, which offer far superior sound quality. Automatic changeover between digital and analogue ensures optimum reception of the selected station. Reception is dependent on local digital network availability.

* Notes: see page 121.

1 Online services

Sound Package Plus.

For sophisticated ears, the optional Sound Package Plus, with a total output of 185 watts, creates an enhanced sound experience with no fewer than seven loudspeakers. Audio settings are entered using the CDR audio system, the optional CDR Plus audio system, or the optional Porsche Communication Management (PCM).

BOSE® Surround Sound System.

The optional BOSE® Surround Sound System really strikes a chord.

It comprises eight amplifier channels with a total output of 445 watts. Its 10 loudspeakers, including an active subwoofer concealed behind the dashboard, deliver a balanced acoustic pattern.

In combination with the CDR Plus audio system and optional Porsche Communication Management (PCM), the BOSE® Surround Sound System enables audio playback of DVDs and is thus able to make full use of the impressive sound spectrum of 5.1 digital recordings. Of course, you can still play other audio sources, such as CDs and MP3s, in stereo or, at the push of a button, in one of the virtual surround modes generated by BOSE® Centerpoint® 2.

The BOSE®-patented AudioPilot® noise compensation technology uses a microphone to continuously measure the ambient noise inside the vehicle and adapts music playback instantly and automatically so that a consistent sound is maintained – whatever the driving conditions. The result is a balanced, faithfully reproduced sound and a captivating 360° acoustic experience.

1 BOSE® Surround Sound System



Burmester® High-End Surround Sound System.

Any car manufacturer can integrate a sound system into a vehicle. Why not go one step further and embed the driver in a sound system? That was the aspiration for Porsche and Burmester® in the development of the optional Burmester® High-End Surround Sound System. Conceived and tuned specifically for the Boxster, this is high-end technology 'made in Germany'.

Components used in the car are as sophisticated as the components that Burmester® puts into its high-end home audio systems. How do the numbers sound? Twelve amplifier channels with a total output of 821 watts and 12 loudspeakers including an active subwoofer. The active subwoofer is integrated in the bodyshell itself. Not only does this provide ideal conditions for the sound, it is consistent with the principles of lightweight construction as applied in motorsport.

Conceptually, we have broken entirely new ground. The analogue and digital filters of the crossover technology used have been optimally defined for their installation location and finely tuned following extensive in-car audio testing. The perfect interaction of all loudspeakers delivers superior bass foundation, definition and impulse accuracy.

As yet unequalled in the Boxster, the result is a natural and richly textured spatial sound, even at top volume. All of this is achieved despite the system's remarkably low overall weight thanks to intelligent Burmester® lightweight technology.

The pure, sporty design makes it clear that the appeal of the Burmester® High-End Surround Sound System is as much about the visual as it is the audio. Typically Porsche.

1-3 Burmester® High-End Surround Sound System



Free style



Stereotype or model character?

Personalisation.

The Boxster models lend a completely new, edgy character to the roadster concept. Because it's you who adds the finishing design touches to such a personal car – right from the moment you order it.

The following pages feature all of the available products. For your convenience, each one has been arranged into the appropriate category. For more information on the options featured in this catalogue, please refer to the separate price list.

The extensive colour palette, for example, gives you the opportunity to

make your Boxster even more personal. You have a choice of four solid colours, eight metallic colours, three special colours, four hood colours and fourteen interior colours. And with the GTS interior package you can further enhance the Boxster GTS with sporty contrasts in Carmine Red or Rhodium Silver.

Of course, you can choose to have your Boxster finished in virtually any other colour of your choice. For further information, please refer to the Porsche Exclusive Boxster catalogue. It offers an even more comprehensive selection of personalisation options for your Boxster and a way to turn something special into something unique.

With our Porsche Tequipment range of accessories, you can always customise your Porsche at a later time. Please consult your Porsche Centre for more details.

Using the Porsche Car Configurator at www.porsche.com, you can transform your ideas into reality. Here, you can design your very own Boxster model from the ground up. The choice of colour or additional equipment, as always, is up to you.

1 Boxster with leather package in Agate Grey and Lime Gold, Porsche Doppelkupplung (PDK) and other optional equipment



Solid exterior colours.

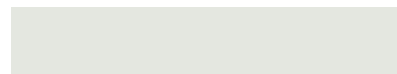

White



Racing Yellow



Guards Red



Black



Hood colours.



Black



Metallic exterior colours.

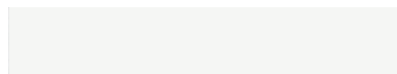

Carrara White Metallic¹⁾

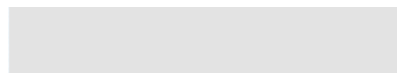

Rhodium Silver Metallic



Sapphire Blue Metallic



Dark Blue Metallic



¹⁾ Not available until 06/2014.



Blue



Mahogany Metallic



Anthracite Brown Metallic

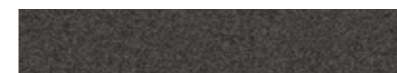

Agate Grey Metallic



Jet Black Metallic¹⁾



Special exterior colours.



GT Silver Metallic



Lime Gold Metallic



Carmine Red









Brown



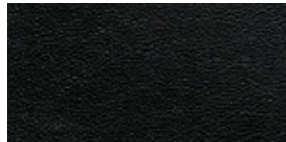

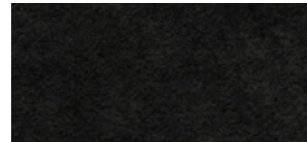
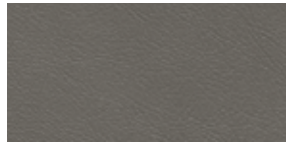
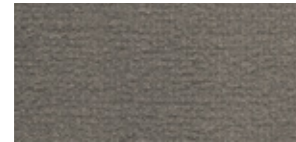
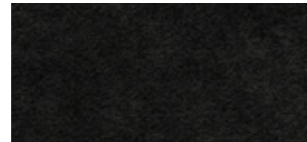
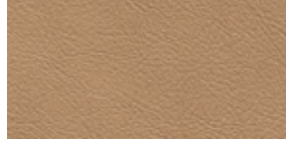
Red

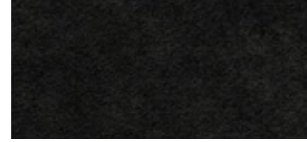

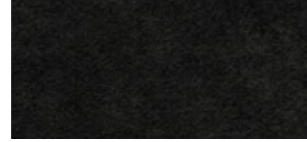

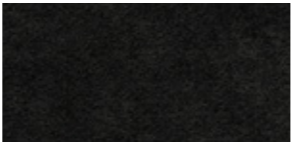

Standard interior colours.

Leatherette/leather ¹⁾ /soft-touch paint ²⁾ Interior colour.	Carpet.	Roof lining.
 Black	 Black	 Black
 Platinum Grey	 Platinum Grey	 Black
 Luxor Beige ¹⁾	 Luxor Beige	 Black ¹⁾
 Yachting Blue	 Yachting Blue	 Black

Leather package ^{1),2),3)} (also available in standard colours) Interior colour.	Carpet.	Roof lining.
 Agate Grey and Lime Gold	 Agate Grey	 Black
 Agate Grey and Pebble Grey	 Agate Grey	 Black
 Agate Grey and Amber Orange	 Agate Grey	 Black

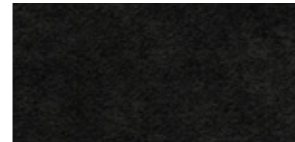
See separate price list for recommended colour combinations.
¹⁾ In conjunction with the leather interior or leather package in Luxor Beige, the roof lining, A-pillar trims, cowl panel and sun visors are in the interior colour.
²⁾ Soft-touch paint in interior colour; A-pillar trims, cowl panel, sun visors in black and inner door sill guards with interior colour film finish.
³⁾ In Lime Gold, Pebble Grey or Amber Orange leather: instrument shroud, seat centres, door pulls, door armrests and centre console main storage compartment lid.
⁴⁾ In Agate Grey/Black: dashboard including instrument shroud, steering wheel rim and airbag module, door panel upper sections, centre console trim. All other parts in Lime Gold, Pebble Grey, Amber Orange or Luxor Beige.

Two-tone combination⁴⁾, special colour and natural leather interior.

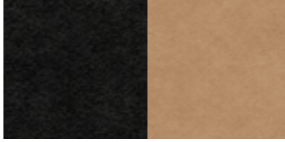
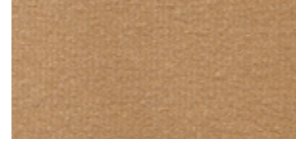
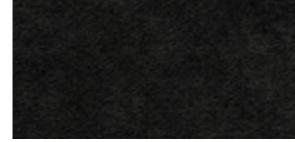



Leather/soft-touch paint ²⁾ Interior colour.	Carpet.	Roof lining.
 Agate Grey and Lime Gold	 Lime Gold	 Black
 Agate Grey and Pebble Grey	 Pebble Grey	 Black
 Agate Grey and Amber Orange	 Amber Orange	 Black
 Black and Luxor Beige	 Luxor Beige	 Black

Leather in special colour/ soft-touch paint ²⁾ Interior colour.	Carpet.	Roof lining.
 Agate Grey	 Agate Grey	 Black
Natural leather/ soft-touch paint ²⁾ Interior colour.	Carpet.	Roof lining.
 Espresso	 Espresso	 Black
 Garnet Red	 Garnet Red	 Black

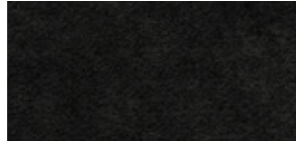

GTS interior package.^{5), 6)}

Leather/Alcantara/soft-touch paint²⁾

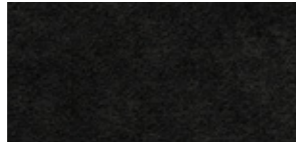
Interior colour.	Carpet/floor mats.	Roof lining.
 Black and Carmine Red	 Black and Carmine Red	 Black
 Black and Rhodium Silver	 Black and Rhodium Silver	 Black

See separate price list for recommended colour combinations.

⁵⁾ Alcantara finish in conjunction with interior colour Black or GTS interior package: lower section of dashboard, seat centres, door armrests, door centre panels and door pulls, centre console storage compartment lid (partially), steering wheel and gear lever/selector.
Note: Alcantara finish not available in conjunction with any other colours. Interior colour Black optionally available without Alcantara trim.

⁶⁾ Carmine Red or Rhodium Silver finish: 'GTS' logo on headrests, 'PORSCHE' logo on floor mats, floor mat edging, leather interior package seams. Also, rev counter dial and seatbelt edges finished in contrasting colour; dashboard, door panel and centre console trim strips in carbon.



Roll-over bars painted in exterior colour, wind deflector



Bi-Xenon headlight including PDLs



ParkAssist (front)



ParkAssist (rear)

Option	Boxster	Boxster S	Boxster GTS	I no.	Page
Exterior.					
Metallic paint	<input type="radio"/>	<input type="radio"/>	<input type="radio"/>	Code	108
Special colours	<input type="radio"/>	<input type="radio"/>	<input type="radio"/>	Code	109
Colours to sample	<input type="radio"/>	<input type="radio"/>	<input type="radio"/>	Code	–
Bi-Xenon headlights including Porsche Dynamic Light System (PDLs)	<input type="radio"/>	<input type="radio"/>	<input checked="" type="radio"/>	603	68
Bi-Xenon headlights including Porsche Dynamic Light System Plus (PDLs+)	<input type="radio"/>	<input type="radio"/>	<input type="radio"/>	632	69
Porsche Entry & Drive	<input type="radio"/>	<input type="radio"/>	<input type="radio"/>	625	93
Deletion of model designation	<input type="checkbox"/>	<input type="checkbox"/>	<input type="checkbox"/>	498	–
ParkAssist (rear)	<input type="radio"/>	<input type="radio"/>	<input type="radio"/>	635	92, 114
ParkAssist (front and rear)	<input type="radio"/>	<input type="radio"/>	<input type="radio"/>	636	92, 114
ParkAssist (front and rear) including reversing camera	<input type="radio"/>	<input type="radio"/>	<input type="radio"/>	638	92, 93
Windscreen with grey top-tint	<input type="radio"/>	<input type="radio"/>	<input type="radio"/>	567	–
Automatically dimming mirrors with integrated rain sensor	<input type="radio"/>	<input type="radio"/>	<input type="radio"/>	P13	–
Electrically folding exterior mirrors with courtesy lighting	<input type="radio"/>	<input type="radio"/>	<input type="radio"/>	748	–
Roll-over bars painted in exterior colour	<input type="radio"/>	<input type="radio"/>	<input type="radio"/>	546	114
Roll-over bars in Aluminium Look	<input type="radio"/>	<input type="radio"/>	<input type="radio"/>	547	–
Wind deflector	<input type="radio"/>	<input checked="" type="radio"/>	<input checked="" type="radio"/>	551	85, 114

The vehicles illustrated in the chapter on personalisation may include additional options not featured in this catalogue. For information on these options, please consult your Porsche Centre. For more information on the options featured in this catalogue, please refer to the separate price list.

Option	Boxster	Boxster S	Boxster GTS	I no.	Page
Engine, transmission and chassis.					
Porsche Doppelkupplung (PDK)	<input type="radio"/>	<input type="radio"/>	<input type="radio"/>	250	41
Porsche Ceramic Composite Brake (PCCB)	<input type="radio"/>	<input type="radio"/>	<input type="radio"/>	450	53
Porsche Active Suspension Management (PASM)	<input type="radio"/>	<input type="radio"/>	<input checked="" type="radio"/>	475	46
Sports chassis (–20 mm)	<input type="radio"/>	<input type="radio"/>	<input type="checkbox"/>	X73	–
Porsche Torque Vectoring (PTV) including mechanically locking rear differential	<input type="radio"/>	<input type="radio"/>	<input type="radio"/>	220	56
Power steering Plus	<input type="radio"/>	<input type="radio"/>	<input type="radio"/>	658	49
Sport Chrono Package including dynamic gearbox mounts	<input type="radio"/>	<input type="radio"/>	<input checked="" type="radio"/>	639	59, 60
Sports exhaust system	<input type="radio"/>	<input type="radio"/>	<input checked="" type="radio"/>	XLF	38

– not available I number/extra-cost option • standard equipment available at no extra cost



Stopwatch (Sport Chrono Package)

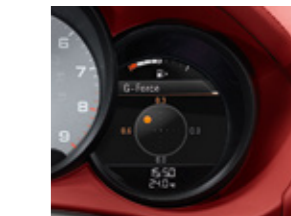

G-Force display (Sport Chrono Package)

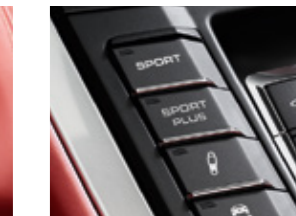

SPORT PLUS button (Sport Chrono Package), PASM button



PDK gearshift switches on multifunction steering wheel



PDK gear selector



18-inch Cayman wheel



19-inch Cayman S wheel



20-inch Carrera S wheel, painted in satin black



20-inch Carrera Classic wheel



20-inch 911 Turbo wheel



20-inch SportTechno wheel

Option

Wheels.

Option	Boxster	Boxster S	Boxster GTS	I no.	Page
18-inch Cayman wheels	<input type="radio"/>	-	-	396	116
19-inch Cayman S wheels	<input type="radio"/>	<input type="radio"/>	-	406	116
19-inch Boxster S wheels	<input type="radio"/>	•	-	400	50
20-inch Carrera S wheels	<input type="radio"/>	<input type="radio"/>	•	423	50, 116
20-inch Carrera Classic wheels	<input type="radio"/>	<input type="radio"/>	<input type="radio"/>	427	116
20-inch 911 Turbo wheels	<input type="radio"/>	<input type="radio"/>	<input type="radio"/>	429	116
20-inch SportTechno wheels including wheel centres with full-colour Porsche Crest	<input type="radio"/>	<input type="radio"/>	<input type="radio"/>	XRT	116
Wheels painted in satin black including wheel centres with full-colour Porsche Crest ^{1), 2)}	-	-	<input type="radio"/>	344	116
Wheel centres with full-colour Porsche Crest	<input type="radio"/>	<input type="radio"/>	<input type="radio"/>	446	116

The vehicles illustrated in the chapter on personalisation may include additional options not featured in this catalogue. For information on these options, please consult your Porsche Centre. For more information on the options featured in this catalogue, please refer to the separate price list.

Option

Interior.

Option	Boxster	Boxster S	Boxster GTS	I no.	Page
HomeLink® (programmable garage door opener)	<input type="radio"/>	<input type="radio"/>	<input type="radio"/>	608	88, 117
Cruise control	<input type="radio"/>	<input type="radio"/>	<input type="radio"/>	454	90, 117
Adaptive cruise control including Porsche Active Safe (PAS)	<input type="radio"/>	<input type="radio"/>	<input type="radio"/>	456	90, 117
Speed limit indicator	<input type="radio"/>	<input type="radio"/>	<input type="radio"/>	631	92
Two-zone automatic climate control	<input type="radio"/>	<input type="radio"/>	<input type="radio"/>	573	88
Alarm system with interior surveillance	<input type="radio"/>	-	-	534	88
Interior surveillance	-	<input type="radio"/>	<input type="radio"/>	534	88
Preparation for Porsche Vehicle Tracking System (PVTS)	<input type="radio"/>	<input type="radio"/>	<input type="radio"/>	674	88
Light design package	<input type="radio"/>	<input type="radio"/>	<input type="radio"/>	630	88, 117

¹⁾ Only in conjunction with 20-inch Carrera S wheel.
²⁾ Not available until 06/2014.

- not available I number/extra-cost option • standard equipment available at no extra cost



HomeLink®



Cruise control

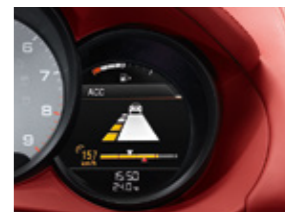

Adaptive cruise control



Light design package



Light design package



Memory package (fully electric Sports seats or adaptive Sports seats Plus)



Seat heating, seat ventilation, two-zone automatic climate control



Key switch (ISOFIX for passenger seat)



Floor mat



Smoking package

Option	Boxster	Boxster S	Boxster GTS	I no.	Page
Interior.					
Sports seats (2-way, electric)	•	•	–	–	82
Fully electric Sports seats (14-way, electric) with memory package including electric steering wheel adjustment	○	○	–	P06	82
Sports seats Plus (2-way, electric)	○	○	•	P04	82
Adaptive Sports seats Plus (18-way, electric) with memory package including electric steering wheel adjustment	○	○	○	P07	82
Sports bucket seats	○	○	○	P03	82
Seat heating	○	○	○	342	82, 118
Seat ventilation	○	○	○	541	82, 118
Steering wheel heating	○	○	○	345	81
Fire extinguisher	○	○	○	509	–
Smoking package	□	□	□	583	118
Floor mat	○	○	○	810	118
ISOFIX child seat preparation for passenger seat	○	○	○	899	82, 118

The vehicles illustrated in the chapter on personalisation may include additional options not featured in this catalogue. For information on these options, please consult your Porsche Centre. For more information on the options featured in this catalogue, please refer to the separate price list.

Option	Boxster	Boxster S	Boxster GTS	I no.	Page
Interior.					
Partial leather seats	○	○	–	946	–
Leather package	○	○	–	980	78, 110
Leather interior package in standard colour	○	○	□	Code	110
Leather interior package in special colour	○	○	○	Code	111
Leather interior package in two-tone combination	○	○	○	970	111, 119
Leather interior package in natural leather	○	○	○	998	111, 119
Leather interior package in colour to sample	○	○	–	Code	–
Brushed aluminium interior package in black ¹⁾	–	–	○	P2A	119
Brushed aluminium centre console trim in black ¹⁾	–	–	○	809	119
GTS interior package	–	–	○	088	79, 113
Multifunction steering wheel	○	○	○	844	81
SportDesign steering wheel	○	○	•	840	81

¹⁾ Not available until 06/2014.

– not available ○ I number/extra-cost option • standard equipment □ available at no extra cost



Two-tone leather interior package in Agate Grey and Pebble Grey and other optional equipment available from selected product ranges including Porsche Exclusive



Boxster GTS with brushed aluminium interior package in black and brushed aluminium centre console trim in black



CDR audio system with optional six-disc CD autochanger



Universal audio interface (AUX)

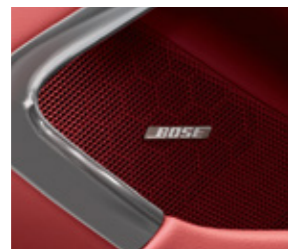

BOSE® Surround Sound System

Option	Boxster	Boxster S	Boxster GTS	I-no.	Page
Audio and communication.					
CDR audio system with AUX interface ¹⁾	•	•	•	–	94, 120
CDR Plus audio system including digital radio and AUX and USB interface ^{1),5)}	○	○	○	P25	94
Six-disc CD autochanger ^{1),2)}	○	○	○	692	94, 120
Porsche Communication Management (PCM) including navigation module with AUX and USB interface ^{1),5)}	○	○	○	P23	94, 121
Six-disc CD/DVD autochanger ^{1),3)}	○	○	○	693	94
Electronic logbook ⁴⁾	○	○	○	641	96, 121
Voice control system ⁴⁾	○	○	○	671	96
Telephone module ^{3),6)}	○	○	○	666	96
Bluetooth® handset for telephone module ⁴⁾	○	○	○	669	97, 99, 121
Mobile phone preparation ⁶⁾	○	○	○	619	96
TV tuner ^{4),7)}	○	○	○	676	96
Online services ^{4),8)}	○	○	○	UN1	99
Digital radio ⁴⁾	○	○	○	691	99

Option	Boxster	Boxster S	Boxster GTS	I-no.	Page
Audio and communication.					
Sound Package Plus	○	○	○	490	100
BOSE® Surround Sound System	○	○	○	680	100, 120
Burmester® High-End Surround Sound System	○	○	○	682	102, 121



Porsche Communication Management (PCM) including navigation module



Electronic logbook



Bluetooth® handset



Universal audio interface (AUX, USB, e.g. for iPod®)

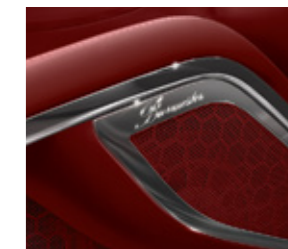

Burmester® High-End Surround Sound System

¹⁾ May be incompatible with some copy-protected audio CDs (CDR) or audio CDs/DVDs (CDR Plus, PCM).

²⁾ Only in conjunction with CDR.

³⁾ Only in conjunction with CDR Plus or PCM.

⁴⁾ Only in conjunction with PCM.

⁵⁾ For information on compatibility with iPod® and iPhone® models, please contact your Porsche Centre.

⁶⁾ The use of a mobile phone or telephone module in HFP mode: the use of a mobile phone inside a car may cause an increase in the interior electromagnetic field strength and, accordingly, in the electromagnetic radiation to which passengers are exposed. If a cradle is used to mount the mobile phone, the field strength in the passenger compartment can be reduced because the phone can be connected up to the external aerial (feature depends on how specific mobile phones connect to the cradle). For information about the availability of an upgrade kit for your mobile phone, please contact your accessories supplier.
The use of the telephone module for CDR Plus and/or PCM via a Bluetooth® SAP connection or with inserted SIM card prevents exposure to electromagnetic radiation as only the car's external aerial is ever used. Information on compatible mobile phones can be obtained from www.porsche.com or from your Porsche Centre.

⁷⁾ For receiving digital TV signals (DVB-T and MPEG-2 encoded signals) where available.

⁸⁾ Use of Aha Radio services with the optional telephone module requires activation of HFP mode in PCM.

The vehicles illustrated in the chapter on personalisation may include additional options not featured in this catalogue.

For information on these options, please consult your Porsche Centre.

For more information on the options featured in this catalogue, please refer to the separate price list.

– not available ○ 1 number/extra-cost option • standard equipment □ available at no extra cost

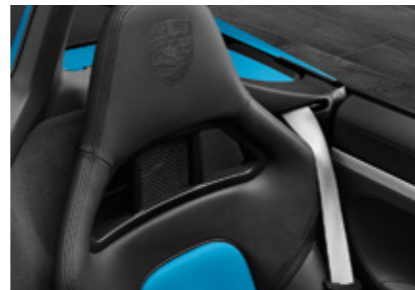

Porsche Exclusive.

Creative freedom is another form of exclusivity.

With the range of options featured in this catalogue, you can make your Porsche even more special. Introducing Porsche Exclusive. Have your vehicle individually

and exclusively tailored to your wishes, even before it leaves the factory. Aesthetically and technically, inside and outside, using fine materials and with customary Porsche quality.

Our overriding principle? That your car is uniquely handcrafted to your taste. You will find a wide range of design options in the separate Porsche Exclusive Boxster catalogue.

Either your Porsche Centre or the customer centre in Zuffenhausen (customercenter-exclusive@porsche.de or phone +49 (0)711 911-25977) will be happy to answer any questions about Porsche Exclusive that you may have.

Porsche Car Configurator.

Independence begins with an idea.

Taste, personality and style. You decide how to refine the Boxster to your personal preference. With the Porsche Car Configurator, you can see the result instantly on your computer. Create your Porsche in just four steps. An interactive 3D tool then enables you to view the car inside and out in a daytime or night-time setting.

Visit www.porsche.com to find the Porsche Car Configurator and discover much more about the fascination of Porsche.

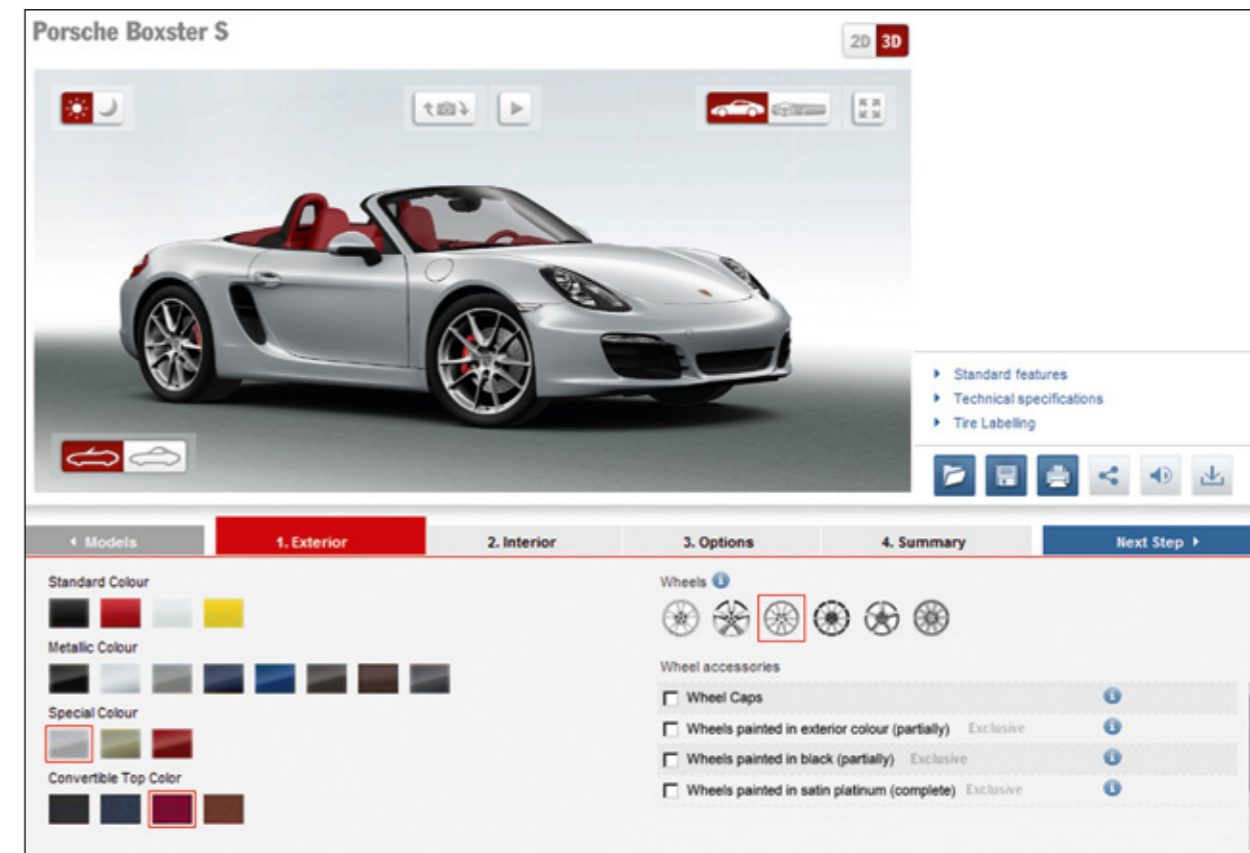

Porsche Driving Experience.

Porsche Sport Driving School.

At Porsche, we are working not only on the evolution of the sports car, but also on the development of the drivers. Safe driving on the road may be second nature, but what about mastering control of a sports car at the limits of sporty performance? We will help you to perfect your driving safety as well as your advanced skills and techniques, step by step.

Under the supervision of our experienced Porsche instructors in your own car or in one provided by the Porsche Sport Driving School, you can refine your ability on-road or off-road, on international racetracks or on ice or snow. We will be by your side from the start and, if it is your aim, we will accompany you through every training level on the way to obtaining your motorsport licence.

Porsche Travel Club.

With the Porsche Travel Club, your holiday begins in the very first second – the moment you step inside the vehicle. Leave everyday life behind and join us in some of the most beautiful regions in the world. We look forward to you being our guest. Whether you are here for several hours or several days, your constant companion will be a Porsche. A unique experience awaits and includes an exclusive hospitality package. You will

stay in first-class hotels and dine in the best restaurants your chosen route has to offer. The Porsche Travel Club gives you access to the very thing that words cannot describe: the authentic driving feel of a Porsche.

Visit www.porsche.com/drivingexperience and discover more about everything the Porsche Driving Experience has to offer.

Factory collection.

The first time that you drive your new Porsche will be a truly special moment. However, you can make it even more special with Porsche factory collection. Come and collect your Porsche in Stuttgart-Zuffenhausen or Leipzig and be the one to take it to its rightful place: on the road.

Before this, we invite you behind the scenes of the Porsche production process. As part of a guided factory tour, you will see how much passion and

precision goes into everything we do. You can then take time to reflect on your experience over a leisurely lunch and look forward to the high point of the day: taking delivery of your Porsche. Our specialists will take their time to explain everything about your new car in as much detail as you wish.

That leaves you with just one more thing to decide: from which factory to collect your Porsche? Stuttgart-Zuffenhausen is steeped in tradition and history. Here, you

can visit the Porsche Museum to experience and learn about every aspect of the Porsche marque, with legendary models from a sports car history spanning over 60 years.

Or, if you would prefer your factory collection to be a little more on the sporty side, visit our production location in Leipzig. Your first driving experience will be a test drive in a Porsche model identical to the one you purchased and under the expert supervision of one of our

instructors. Hone your skills either on-road on the FIA-certified test circuit or on our very own off-road track in a Porsche off-road vehicle.

If you do opt for the factory collection, please contact your Porsche Centre to arrange a collection date. We will be happy to assist in the planning of your trip. You will also be given information on the formalities, legal or otherwise, to be completed before you can take delivery.

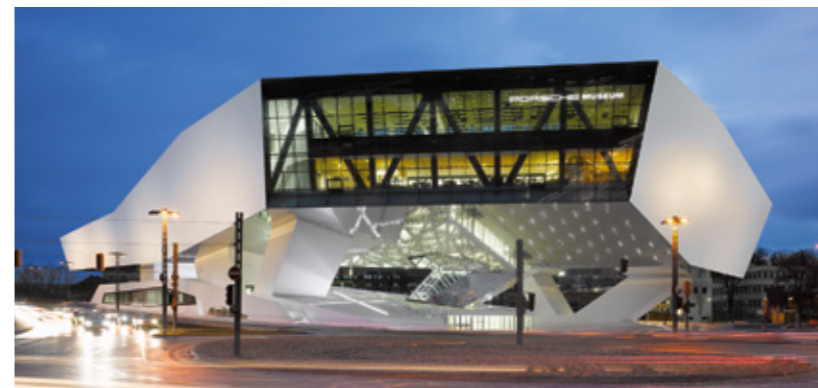



Porsche Centres

Your Porsche Centre can assist you with every aspect of purchasing and owning your Porsche. You will also find a wide range of products and services, including genuine Porsche parts and top-quality accessories.



Porsche Exclusive

Realise your vision of the perfect Porsche with our factory customisation programme. From styling enhancements to performance upgrades, all modifications are uniquely handcrafted for your Porsche.



Porsche Tequipment

Personalise your Porsche at any time after purchase with our range of aftermarket accessories. You will also find all our available products online at www.porsche.com/tequipment using the Tequipment accessories finder.



Porsche Driver's Selection

With products ranging from fashion and accessories to tailored luggage, this unique collection combines quality and style with everyday practicality.



Porsche Travel Club

Embark on a thrilling adventure and feel the power of Porsche. Stay in top-class hotels and dine in five-star restaurants. Worldwide. To find out more, call +49 (0)711 911-23360. E-mail: info@porschetravelclub.de



Porsche Sport Driving School

Develop your skill and explore your Porsche with the Porsche Sport Driving School. Learn about events at some of the world's most famous racing venues, call +49 (0)711 911-23364. E-mail: info@porscheporstdrivingsschool.de



Porsche Clubs

Since the first Porsche Club was founded in 1952, their number has grown to 640 with a total of 181,000 members worldwide. To find out more, go to www.porsche.com/clubs or call +49 (0)711 911-23252.

Panorama.

Porsche Service

Your expert partner for all current Porsche models as well as old and modern classics, whether your car needs servicing, routine care or special repairs.

Porsche Assistance

Enjoy peace of mind with our exclusive breakdown and accident recovery service. Membership is free when you buy a new Porsche.

Porsche Approved

So that our vehicles remain reliable and retain their value whether new or previously owned, all Porsche Approved cars meet the most stringent Porsche quality standards across the world. Each car is backed by the Porsche Approved warranty.

Porsche Financial Services

Our range of financial services is innovative and specially tailored to the needs of Porsche owners. Products range from attractive finance and leasing options to vehicle insurance and the Porsche Card.

Christophorus

Our bimonthly magazine for Porsche owners has news, interviews and a wide variety of features from throughout the world of Porsche.

Porsche Classic

Your specialist source for genuine Porsche parts as well as restoration services for all Porsche classics. Visit www.porsche.com/classic to find out more.

Porsche Museum

More than 80 vehicles at our headquarters in Stuttgart-Zuffenhausen await to take you on a journey through Porsche history. See icons such as the 356, 911 and 917 presented in an atmosphere you can't experience anywhere else.

Porsche Online

Go to www.porsche.com for all the latest news and information from Porsche.



You can obtain the latest brochures for Porsche Exclusive, Porsche Tequipment, Porsche Driver's Selection and Porsche Driving Experience from your Porsche Centre.



Spirit, declared.

To us, independence is primarily a feeling, but it is also a guiding principle. It is the principle by which we can think for ourselves, explore our own direction and live our own lives.

How better to do this than in a roadster, a concept in which freedom of spirit has always been the core idea?

Symbols of freedom may have changed over the years, but freedom itself is instantly perceptible. You can see it, hear it and feel it – from one twist and turn to the next.

The Boxster.
Spirit, declared.



Technical data.

	Boxster	Boxster S
Engine		
Cylinders	6	6
Displacement	2,706 cm³	3,436 cm³
Max. power (DIN) at rpm	195 kW (265 hp) 6,700	232 kW (315 hp) 6,700
Max. torque at rpm	280 Nm 4,500–6,500	360 Nm 4,500–5,800
Compression ratio	12.5:1	12.5:1
Transmission		
Layout	Rear-wheel drive	Rear-wheel drive
Manual transmission	6-speed	6-speed
Porsche Doppelkupplung (PDK), optional	7-speed	7-speed
Chassis		
Front axle	Lightweight spring-strut suspension	Lightweight spring-strut suspension
Rear axle	Lightweight spring-strut suspension	Lightweight spring-strut suspension
Steering	Variable steering ratio, power-assisted (electromechanical)	Variable steering ratio, power-assisted (electromechanical)
Turning circle	10.98 m	10.98 m
Brakes	Four-piston aluminium monobloc fixed calipers front and rear, discs internally vented and cross-drilled	Four-piston aluminium monobloc fixed calipers front and rear, discs internally vented and cross-drilled
Vehicle stability system	Porsche Stability Management (PSM) with ASR, ABD, MSR and ABS 9.0	Porsche Stability Management (PSM) with ASR, ABD, MSR and ABS 9.0
Standard wheels	Front: 8 J x 18 ET 57, Rear: 9 J x 18 ET 47	Front: 8 J x 19 ET 57, Rear: 9.5 J x 19 ET 45
Standard tyres	Front: 235/45 ZR 18, Rear: 265/45 ZR 18	Front: 235/40 ZR 19, Rear: 265/40 ZR 19

	Boxster GTS
Engine	
Cylinders	6
Displacement	3,436 cm³
Max. power (DIN) at rpm	243 kW (330 hp) 6,700
Max. torque at rpm	370 Nm 4,500–5,800
Compression ratio	12.5:1
Transmission	
Layout	Rear-wheel drive
Manual transmission	6-speed
Porsche Doppelkupplung (PDK), optional	7-speed
Chassis	
Front axle	Lightweight spring-strut suspension, regulated shock absorber system
Rear axle	Lightweight spring-strut suspension, regulated shock absorber system
Steering	Variable steering ratio, power-assisted (electromechanical)
Turning circle	10.98 m
Brakes	Four-piston aluminium monobloc fixed calipers front and rear, discs internally vented and cross-drilled
Vehicle stability system	Porsche Stability Management (PSM) with ASR, ABD, MSR and ABS 9.0
Standard wheels	Front: 8 J x 20 ET 57, Rear: 9.5 J x 20 ET 45
Standard tyres	Front: 235/35 ZR 20, Rear: 265/35 ZR 20



	Boxster	Boxster S	Boxster GTS
Unladen weight	Manual/PDK	Manual/PDK	Manual/PDK
DIN	1,330 kg/1,360 kg	1,340 kg/1,370 kg	1,345 kg/1,375 kg
Unladen weight (EC) ¹⁾	1,405 kg/1,435 kg	1,415 kg/1,445 kg	1,420 kg/1,450 kg
Permissible gross weight	1,645 kg/1,675 kg	1,655 kg/1,685 kg	1,655 kg/1,685 kg
Performance	Manual/PDK	Manual/PDK	Manual/PDK
Top speed	264 km/h/262 km/h	279 km/h/277 km/h	281 km/h/279 km/h
0–100 km/h	5.8 secs/5.7 secs	5.1 secs/5.0 secs	5.0 secs/4.9 secs
With Sport Chrono Package (with PDK) ²⁾ 0–100 km/h	–/5.5 secs	–/4.8 secs	–/4.7 secs
0–160 km/h	13.1 secs/13.0 secs	11.0 secs/10.9 secs	10.8 secs/10.7 secs
With Sport Chrono Package (with PDK) ²⁾ 0–160 km/h	–/12.7 secs	–/10.7 secs	–/10.5 secs
Flexibility (80–120 km/h), in 5th gear	8.2 secs/–	6.7 secs/–	6.7 secs/–
Overtaking acceleration (80–120 km/h)	–/3.7 secs	–/3.1 secs	–/3.0 secs
Fuel consumption/emissions³⁾	Manual/PDK	Manual/PDK	Manual/PDK
Urban in l/100 km	11.8/10.9	12.7/11.4	12.7/11.4
Extra urban in l/100 km	6.4/6.2	7.1/6.3	7.1/6.3
Combined in l/100 km	8.4/7.9	9.0/8.2	9.0/8.2
CO ₂ emissions in g/km	195/183	211/190	211/190
Efficiency class⁴⁾	Manual/PDK	Manual/PDK	Manual/PDK
Efficiency class (Germany)	G/F	G/F	G/F
Efficiency class (Switzerland)	G/G	G/G	G/G
Dimensions/aerodynamics			
Length	4,374 mm	4,374 mm	4,404 mm
Width (including exterior mirrors)	1,801 mm (1,978 mm)	1,801 mm (1,978 mm)	1,801 mm (1,978 mm)
Height	1,282 mm	1,281 mm	1,273 mm
Wheelbase	2,475 mm	2,475 mm	2,475 mm
Luggage compartment volume (German Car Manufacturers' Assoc.) front/rear	150 litres/130 litres	150 litres/130 litres	150 litres/130 litres
Tank capacity (refill volume)	approx. 64 litres	approx. 64 litres	approx. 64 litres
Drag coefficient	0.30	0.31	0.32

¹⁾ Weight is calculated in accordance with the relevant EC Directives and is valid for vehicles with standard specification only. Optional equipment increases this figure. The figure given includes 68 kg for the driver and 7 kg for luggage.

²⁾ With SPORT PLUS button activated.

³⁾ Data determined in the NEDC (New European Driving Cycle) in accordance with the Euro 6 (715/2007/EC, 195/2013/EC and ECE-R 101.01) measurement method. The figures do not refer to an individual vehicle nor do they constitute part of the offer. They are intended solely as a means of comparing different types of vehicle. Fuel consumption calculated for vehicles with standard specification only. Actual consumption and performance may vary with items of optional equipment. A vehicle's fuel consumption and CO₂ emissions depend not only on its efficient use of fuel, but also on driving style and other non-technical factors. Current Porsche models with petrol engines are designed for fuel containing up to 10% ethanol. You can obtain further information about individual vehicles from your Porsche Centre.

⁴⁾ Valid in the countries listed only.

Tyre identification.

Tyre type	Size	Fuel efficiency class/ rolling resistance	Wet grip class	External rolling noise* class	External rolling noise (dB)
Summer tyres	235/45 ZR 18	E	C	🔊 – 🔊	69–68
	265/45 ZR 18	E	C–B	🔊	69
	235/40 ZR 19	E	B–A	🔊 – 🔊	71–68
	265/40 ZR 19	E	B–A	🔊	72–70
	235/35 ZR 20	F–E	C–A	🔊	72.3–71
	265/35 ZR 20	E	C–A	🔊) – 🔊)	73.9–72

For logistical and technical reasons relating to the production process, we are unable to accept orders for a particular make of tyre.

* 🔊 Quiet rolling noise, 🔊 Moderate rolling noise, 🔊 Loud rolling noise.



Index.

A	C	Engines	32	Interior	14, 76, 110	ParkAssist	92	R	Steering wheels	81	
Adaptive cruise control including	CD/DVD autochanger	94	Boxster engine	20	Interior surveillance system	88	Parking brake, electric	53	Recycling	72	
Porsche Active Safe (PAS)	90	CDR audio system	94	Boxster S engine	24	ISOFIX child seat preparation	82	Personalisation	106	Reversing camera	93
Airbags	66	CDR Plus audio system	94	Boxster GTS engine	28			Porsche Active Suspension Management (PASM)	46	Roll-over protection	66
Air conditioning system	88	Chassis	46	Environment	71	L		Porsche Car Configurator	123	Storage options	86
Alarm system	88	Child seats	82	Exhaust system	38	Leather package	78, 110	Porsche Ceramic Composite Brake (PCCB)	53	S	
Anti-theft protection	88	Coasting	42	Exterior	12, 108	Light design package	88	Brake (PCCB)	53	Safety	64
Audio and communication	94	Colours	108			Lights	68	Porsche Communication Management (PCM)	94	Seat heating	82
Audio interface, universal	94	Exterior	108	F		Locking rear differential, mechanical	56	Porsche Doppelkupplung (PDK)	41	Seats	82
Automatic climate control, two-zone	88	Interior	110	Factory collection	125	Logbook, electronic	96	Porsche Driving Experience	124	Adaptive Sports seats Plus	82
Automatic headlight activation	68	Comfort	76	Floor mats	118	Luggage compartments	87	Porsche Dynamic Light System (PDLs)	68	Child seats	82
Auto start/stop function	36	Cruise control	90	Fuel	73			Porsche Dynamic Light System Plus (PDLs+)	69	Fully electric Sports seats	82
				Fuel consumption	72, 134	M		Porsche Entry & Drive	93	Sports bucket seats	82
B	D					Manual transmission, six-speed	41	Porsche Exclusive	122	Sports seats	82
Bi-Xenon headlights	68	Design	12	G		Materials	72	Porsche Exclusive	122	Sports seats Plus	82
Bluetooth® handset for telephone module	97, 99	Digital radio	99	Gearbox mounts, dynamic	60	Mechanically locking rear differential	56	Porsche Side Impact Protection System (POSIP)	67	Seat ventilation	82
BOSE® Surround Sound System	100	Direct fuel injection (DFI)	35	GTS interior package	79, 113	Mobile phone preparation	96	Porsche Stability Management (PSM)	54	Servicing	73
Boxer engines	32	Dry-sump lubrication, integrated	35			N		Porsche Torque Vectoring (PTV)	56	Smoking package	118
Boxster concept	9	Dynamic gearbox mounts	60	H		Navigation module	94	Porsche Vehicle Tracking System (PVTS)	88	Sound Package Plus	100
Boxster	18			Hood, fully electric	84			Power steering Plus	49	Speed limit indicator	92
Boxster S	22	E		HomeLink® (programmable garage door opener)	88	O		Principle	128	SPORT button	36
Boxster GTS	26	Electrical system recuperation	37			Online services	99			Sport Chrono package	59
Brakes	53	Electric parking brake	53	I						SPORT PLUS button	59
Burmester® High-End Surround Sound System	102	Emission control	71	Instruments	76	P				Sports exhaust system	38
		Engineered body design	64	Integrated dry-sump lubrication	35	Panorama	126			Steering wheel heating	81
		Engine management	36							Steering	48
										Wheels	50, 116
										Wind deflector	85

