

JAGUAR XF SEDAN AND XF SPORTBRAKE 2019



THE ART OF PERFORMANCE





BY APPOINTMENT TO
HM THE QUEEN
MANUFACTURERS OF
MOTOR VEHICLES
JAGUAR LAND ROVER LIMITED
COVENTRY



BY APPOINTMENT TO
HRH THE DUKE OF EDINBURGH
MANUFACTURERS OF
MOTOR VEHICLES
JAGUAR LAND ROVER LIMITED
COVENTRY



BY APPOINTMENT TO
HRH THE PRINCE OF WALES
MANUFACTURERS OF
MOTOR VEHICLES
JAGUAR LAND ROVER LIMITED
COVENTRY



THE ART OF PERFORMANCE

Every day we push performance to its limit. Our performance. Our cars' performance.
We innovate, we engineer, we design. We master rules and then break them.
Only to push further. Past the limits of convention. This is when performance becomes art.
Jaguar. The Art of Performance.





CONTENTS

INTRODUCTION

The Concept of the Jaguar XF	07
The Jaguar XF - The Facts	08

DESIGN

Exterior Principles	10
Exterior Aerodynamics	12
Interior	15
Interior Space	17
Space and Versatility	19

PERFORMANCE

Engines Overview	22
Advanced Aerodynamics	26
Lightweight Aluminum Architecture	29
Chassis and Suspension	30

DRIVING TECHNOLOGY

Advanced Driving Dynamics	32
Added Driver Assurance	34
Advanced Drivetrain Technology	37
Torque Vectoring	39
Stability and Control	41
Head Up Display	43

TECHNOLOGY

Infotainment	43
Connectivity	44
Audio	48

DRIVER ASSISTANCE

50

PERSONALIZATION

The Jaguar XF - Your Choice	52
Choose your Engine	54
Choose your Model	56
Choose your Options	58
Choose your Color	64
Choose your Wheels	66
Choose your Interior	68
Choose your Jaguar Gear - Accessories	80

TECHNICAL DETAILS

88

SPECIAL VEHICLE OPERATIONS

92

THE WORLD OF JAGUAR

94

AT YOUR SERVICE

97

VEHICLES SHOWN: JAGUAR XF SPORTBRAKE S IN YULONG WHITE AND JAGUAR XF SEDAN S IN CORRIS GREY WITH OPTIONAL EQUIPMENT

VEHICLES SHOWN ARE FROM THE JAGUAR GLOBAL RANGE. SPECIFICATIONS, OPTIONS AND AVAILABILITY MAY VARY BETWEEN MARKETS AND SHOULD BE VERIFIED WITH YOUR LOCAL JAGUAR RETAILER





INTRODUCTION

THE CONCEPT OF THE JAGUAR XF

The 2019 Jaguar XF builds on the success of the 2018 Jaguar XF. Possessing an unrivaled combination of style and substance, it delivers an utterly seductive blend of design, dynamics and refinement to create a car that offers true excitement. All enhanced by state-of-the-art technologies that keep you connected and entertained.

The Jaguar XF sits in the Jaguar sedan family between the taut athleticism of the Jaguar XE and the supreme luxury of Jaguar XJ. The fusion of these outstanding Jaguar attributes is what creates the Jaguar XF - one of the most dynamic, premium sports sedans. The New Jaguar XF Sportbrake complements the distinctive 'coupe' lines and dynamism of the Jaguar XF Sedan with even greater space and versatility.

VEHICLES SHOWN: JAGUAR XF SPORTBRAKE S IN YULONG WHITE AND JAGUAR XF SEDAN S IN CORRIS GREY WITH OPTIONAL EQUIPMENT



THE JAGUAR XF - THE FACTS

An outstanding combination of advanced engineering, the latest technology and contemporary design sets Jaguar XF apart.

PERFORMANCE

Find your perfect balance of economy and power in the Jaguar XF Sedan and Sportbrake engine range. Many engines feature our Ingenium technology, including the 2.0 liter 4-cylinder 177HP Turbocharged Diesel. The most powerful Jaguar XF engine, the 3.0 liter V6 380HP Supercharged, can sprint from 0-60 mph in 5.0 seconds¹ and reach a top speed of 121 mph*.

SPORTBRAKE REAR AIR SUSPENSION

Even when fully loaded, the comfort and precise handling of the Jaguar XF Sportbrake is maintained by self-leveling rear air suspension. This system automatically inflates air springs to counteract the weight of heavy loads, helping ensure a level chassis and ride height.

*Always follow local speed limits.

**These features are not a substitute for driving safely with due care and attention and will not function under all circumstances, speeds, weather and road conditions, etc. Driver should not assume that these features will correct errors of judgment in driving. Please consult the owner's manual or your local Jaguar Retailer for more details.

¹Do not use Jaguar InControl[®] features under conditions that will affect your safety or the safety of others. Driving while distracted can result in loss of vehicle control.

¹Engine performance representative of Jaguar XF Sedan AWD only. ²40:20:40 split fold rear seats are standard on Jaguar XF Sportbrake. ³Adaptive Surface Response system is only available on the Jaguar XF S AWD and Jaguar Sportsbrake S models.

For detailed Jaguar XF Sedan and Sportbrake technical specifications, see pages 88 to 89.

Some features described here are optional.

VEHICLES SHOWN: JAGUAR XF SPORTBRAKE S IN YULONG WHITE AND JAGUAR XF SEDAN S IN CORRIS GREY WITH OPTIONAL EQUIPMENT

DYNAMIC DESIGN

With a sleek, low swooping roofline and 17.2 sq ft panoramic glass roof, the Jaguar XF Sportbrake makes no compromise between assertive style and versatility. Perfectly executed to carry more, its proportions have been shaped to achieve aerodynamic excellence.



ADDED INTELLIGENCE

Innovative technologies make driving easier. The Jaguar XF offers optional adaptive LED headlights, Traffic Sign Recognition and Adaptive Speed Limiter, Lane Keep Assist and Driver Condition Monitor, Emergency Braking, Adaptive Cruise Control with Queue Assist**, Park Assist, and now Blind Assist**. On the Sportbrake with Powered Gesture tailgate, you can access the trunk when your hands are full. Simply present your foot under either rear side of the bumper and the trunk opens.

CRAFTSMANSHIP AND SPACE

Contemporary craftsmanship and a luxurious, practical interior with the space to stretch out and enjoy every trip. Front and rear passengers will appreciate leg, knee and headroom that are ample and generous. You can choose the optional 40:20:40 rear seating² configuration for increased volume and versatility.

CONNECTIVITY

Every drive in the Jaguar XF is enhanced by Jaguar InControl[®] Technologies. InControl is a suite of products and services that connects you with your Jaguar XF and links the Jaguar XF to the wider world. It ensures you are always in touch[†].

LIGHTWEIGHT ALUMINUM ARCHITECTURE

The Lightweight Aluminum Architecture of the Jaguar XF creates a strong body that delivers precise and responsive sports handling.

ADVANCED DRIVETRAIN TECHNOLOGY

The Jaguar XF offers All Wheel Drive with Intelligent Driveline Dynamics and Adaptive Surface Response (if fitted to model)³. This enhances the legendary Jaguar handling, agility and ride, and gives added assistance in most conditions^{**}.

ADVANCED AERODYNAMICS

The Jaguar XF has a low drag coefficient which allows it to cut through the air, reducing wind noise for enhanced refinement. The underside of the car is aerodynamically designed to be as smooth as possible, while apertures in the front bumper optimize airflow through the wheel arches.





DESIGN EXTERIOR PRINCIPLES



DESIGN PURITY

ADAPTIVE LED HEADLIGHTS

"It's about paring it down to the bare essentials. Good designers have always said less is more."
Ian Callum, Jaguar Design Director.

The Jaguar XF demonstrates the Jaguar principles of design purity. Strong lines radiate dynamic character and enhance the vehicle capabilities – be it improving aerodynamics, visibility or stability. The Jaguar XF is available with Adaptive LED headlights*¹ complementing the Jaguar signature 'J' blade Daytime Running Lights and giving the vehicle a striking on-road presence. LED light quality is closer to daylight, helping to distinguish objects.

*These features are not a substitute for driving safely with due care and attention and will not function under all circumstances, speeds, weather and road conditions, etc. Driver should not assume that these features will correct errors of judgment in driving. Please consult the owner's manual or your local Jaguar Retailer for more details.

¹Optional feature, Xenon headlights are also available depending on the model chosen.

VEHICLE SHOWN RIGHT: JAGUAR XF SEDAN S IN CORRIS GREY WITH
OPTIONAL EQUIPMENT



776 XCN

EXTERIOR AERODYNAMICS



AERODYNAMIC DESIGN

F-TYPE INSPIRED DESIGN

The sweeping exterior design of the Jaguar XF is naturally aerodynamic. Its advanced form enhances handling, dynamics and refinement. Airflow is carefully managed through and around the car. Intakes either side of the front grille draw air in, then channel it out from the wheel arches to reduce turbulence. As air flows along the car, pressure differences that can cause drag are minimized by the flush, aerodynamically optimized sides.



At the rear, the Jaguar XF sedan tail lights feature a distinctive, Jaguar F-TYPE inspired, double roundel and intersecting horizontal detail. The LED brake lights are not only brighter than halogen bulbs, they use less energy. LEDs also illuminate faster - so following drivers can react more quickly to braking. Within the tail lights is a pinstripe graphic - one of the many exquisite finishing touches on the Jaguar XF.

VEHICLES SHOWN: JAGUAR XF SEDAN S IN CORRIS GREY AND JAGUAR XF SPORTBRAKE S IN YULONG WHITE WITH OPTIONAL EQUIPMENT





Darkness
Clear Visibility
Darkness
4/10

70 90 110 130
50 0 150
30 10 170 190

1 2 3 4 5
P

HOME 14:56

Navigation Arlington Avenue
Leamington Spa
16.5 mi 14:25

Media Bluetooth audio
Young Before Your Time
Corvidae

Phone My iPhone

68° 71°

SYNC

MAX MAX A/C A/C

AUTO

P R N D S



INTERIOR



**DRAMATIC
START-UP SEQUENCE**

**CONTEMPORARY
CRAFTSMANSHIP**

Open the door and the Start button entices you inside. Pulsing with a heartbeat it creates an emotional connection between driver and machine. Its 72 per minute double beat is the same as a jaguar cat at rest. The Jaguar XF is poised, ready for action. Now push the Start button. The car awakens and, if fitted, its mood lighting illuminates. With perfect choreography, air vents rotate open when the climate system is in use, the JaguarDrive Selector™ rises smoothly, and the engine growls - all inspiring you to anticipate the drive ahead.

The Jaguar XF interior offers outstanding comfort, a sense of wellbeing and a wealth of choices. The number of switches and buttons is kept to a minimum to keep the look clean and tidy, as well as making them easy to use. Whichever Jaguar XF interior combination you choose, materials used are always of the highest quality. Leather and finishes are selected with the greatest care to ensure that, inside the Jaguar XF, everything is luxurious to the touch. Whether you prefer aluminum, carbon fiber, or wood veneer finishes to complement the beautiful selection of materials, your Jaguar XF will always look and feel just right.

The XF Sportbrake offers a new ionization system, this technology ionizes particles in the air, making them attract to surfaces and thus helping to cleanse the air. It can be switched on or off.

INTERIOR SHOWN: LIGHT OYSTER AND EBONY PERFORATED GRAINED LEATHER SPORT SEATS WITH EBONY CONTRAST STITCH, EBONY FASCIA WITH LIGHT OYSTER CONTRAST STITCH, DARK HEX ALUMINUM TRIM FINISHER, GREY FIGURED EBONY VENEER AND EBONY SUEDECLOTH HEADLINING





1. Headroom 38 inches (39.1 inches on Jaguar XF Sportbrake) 2. Knee room 3 inches

INTERIOR SPACE



GENEROUS REAR SPACE

IMPRESSIVE VERSATILITY

In both Jaguar XF Sedan and Sportbrake, the rear of the cabin is a destination of luxury, choice and space. With generous rear knee room, rear legroom and rear headroom, there is plenty of room to relax. It all adds up to greater comfort and well being for passengers.

Interior lighting also enhances the atmosphere of the Jaguar XF. Opt for Configurable Ambient Interior Lighting and you'll have a choice of ten ambient interior lighting colors. The choice continues with optional Four-zone Climate Control, giving individual passengers the opportunity to set their own temperature and airflow.

At 17.8 cubic feet, the cargo space of the XF Sedan offers plenty of carrying capacity. For even greater versatility, the 40:20:40 rear seating configuration increases cargo space to an impressive 31.25 cubic feet. This outstanding practicality is taken to the next level in the XF Sportbrake with 31.7 and 69.7 cubic feet of rear cargo space respectively.

INTERIOR SHOWN: JAGUAR XF SEDAN S FEATURING LIGHT OYSTER/EBONY SEATS WITH EBONY UPPER FASCIA WITH CONTRAST STITCH, GREY FIGURED EBONY VENEER, EBONY CARPET AND EBONY SUEDECLOTH HEADLINING WITH OPTIONAL EQUIPMENT



SPACE AND VERSATILITY



SUBSTANTIAL CARGO SPACE

ACTIVITY KEY

The versatile interior of the Jaguar XF Sportbrake is designed to meet the demands of your lifestyle. Its cargo space provides 31.7 cubic feet of space with the rear seats in place. Fold the rear seats down, and you'll create a space that is 79 inches in length and features 69.7 cubic feet of luggage capacity plus discreet underfloor storage.

To make things a bit easier, the Jaguar XF Sportbrake offers a powered gesture tailgate as standard and Activity Key as an option. The Activity Key is a robust and fully waterproof wristband that allows you to enjoy a range of activities - from skydiving to swimming - while giving you immediate access to the car at all times. The conventional key fob can remain within the car as it is deactivated for security purposes.

INTERIOR SHOWN: JAGUAR XF SPORTBRAKE S FEATURING BROGUE SEATS WITH CONTRAST STITCH, EBONY CARPET AND EBONY SUEDECLOTH HEADLINING WITH OPTIONAL EQUIPMENT







40:20:40 SPLIT FOLD SEATS

FIXED PANORAMIC ROOF

The rear seats of the Jaguar XF Sportbrake fold completely flat or can be divided with a 40:20:40 split, using a thoughtfully placed remote release that's accessible from the tailgate area. Easy-to-use optional cargo space rails help further increase the adaptability of cargo space storage, and an available divider net prevents objects from falling onto the rear seats.

Introducing even more natural light and airiness to the interior, is the large, standard fixed panoramic roof in the Jaguar XF Sportbrake.

PERFORMANCE ENGINES OVERVIEW



INGENIUM ENGINES

STOP/START TECHNOLOGY

Ingenium technology underpins the 2.0 liter 4-cylinder diesel and gas engines in the Jaguar XF range. These low friction, all-aluminum engines have stiff cylinder blocks and twin balancer shafts to ensure inherently low levels of vibration, for smooth day-to-day performance. All engines are equipped with Stop/Start technology and smart regenerative charging - harvesting kinetic energy from braking to charge the battery.



INGENIUM DIESEL ENGINE

318 lb-ft of Torque

The Ingenium 2.0 liter 4-cylinder 177HP Turbocharged Diesel offers impressive performance for an engine of this size. It offers high levels of torque - a balance achieved thanks to its variable geometry turbocharger. Adapting to the changing flow of exhaust gases, it maximizes low speed torque for broad power and responsiveness that is uniform, progressive and avoids lag.

The Jaguar XF offers a choice of gas engines, including two from our Ingenium range. With their lightweight, all-aluminum design, and widespread use of low-friction roller bearings, Ingenium gas engines are built for smooth, efficient performance. To guarantee a responsive drive and effortless acceleration, every Jaguar XF gas engine makes use of a rapid-shifting, 8-speed Automatic Transmission. All engines are equipped with Stop/Start technology and smart regenerative charging - harvesting kinetic energy from braking to charge the battery.



INGENIUM GAS ENGINES¹ UP TO

0-60 mph from 5.6 seconds*²

The Ingenium 2.0 liter 4-cylinder 247HP Turbocharged Gas engine delivers outstanding usable power and torque. For excellent acceleration and effortless overtaking, maximum torque is available between 1,300-4,500 rpm. This engine twin scroll turbocharger is fed by an integrated exhaust manifold that synchronizes exhaust pulses from two separate pairs of cylinders - reducing turbo lag and improving engine response.

The Ingenium 2.0 liter 4-cylinder 296HP Turbocharged Gas engine has impressive power and balance. For almost instant boost, its low inertia twin-scroll turbocharger features low-friction ball bearings and a high flow compressor wheel. Underpinned by the turbocharger's increased aerodynamic efficiency, the engine delivers rapid acceleration and maximum torque of 295 lb-ft between 1,500-4,500 rpm.

*Always follow local speed limits.

¹Engine performance figures representative of XF Sedan and Sportbrake technical specifications, see pages 88 to 89.

²Figure representative of the 30t AWD Sedan.



GAS ENGINE¹ UP TO

0-60 mph in 5.0 seconds^{*3}

The 3.0 liter V6 Supercharged Gas engine features a Roots-type twin vortex supercharger that provides linear delivery of power and maximizes responsiveness. This results in performance much like larger engines. The engine also features dual independent variable cam timing to vary inlet and exhaust valve operation, working alongside lightweight pistons with ultra-low friction piston rings, for increased performance. For added refinement there is a twin, contra-rotating balancer shaft system.

³Figure representative of the XF S AWD Sedan.

ADVANCED AERODYNAMICS



LOW DRAG

| CD 0.28¹

The Jaguar XF form has been designed for aerodynamic efficiency and stability at highway speeds. With a drag coefficient as low as Cd 0.28¹, the Jaguar XF cuts through the air – helping to reduce fuel consumption and lower emissions. Every element exploits the maximum aerodynamic potential while preserving the stunning proportions of the Jaguar XF. Apertures in the front bumper outer edges channel air through vents in the wheel arches and out over the front wheels. The airflow then passes along the Jaguar XF sides where the doors have a flatter cross sectional profile to minimize air pressure differences and contribute further to reduced drag. Even the extensive under body protection is designed to make the Jaguar XF as refined as possible.

¹Jaguar XF Sedan only. Drag coefficient for Jaguar XF Sportbrake is Cd 0.29.

VEHICLE SHOWN: JAGUAR XF SEDAN IN SANTORINI BLACK WITH OPTIONAL EQUIPMENT



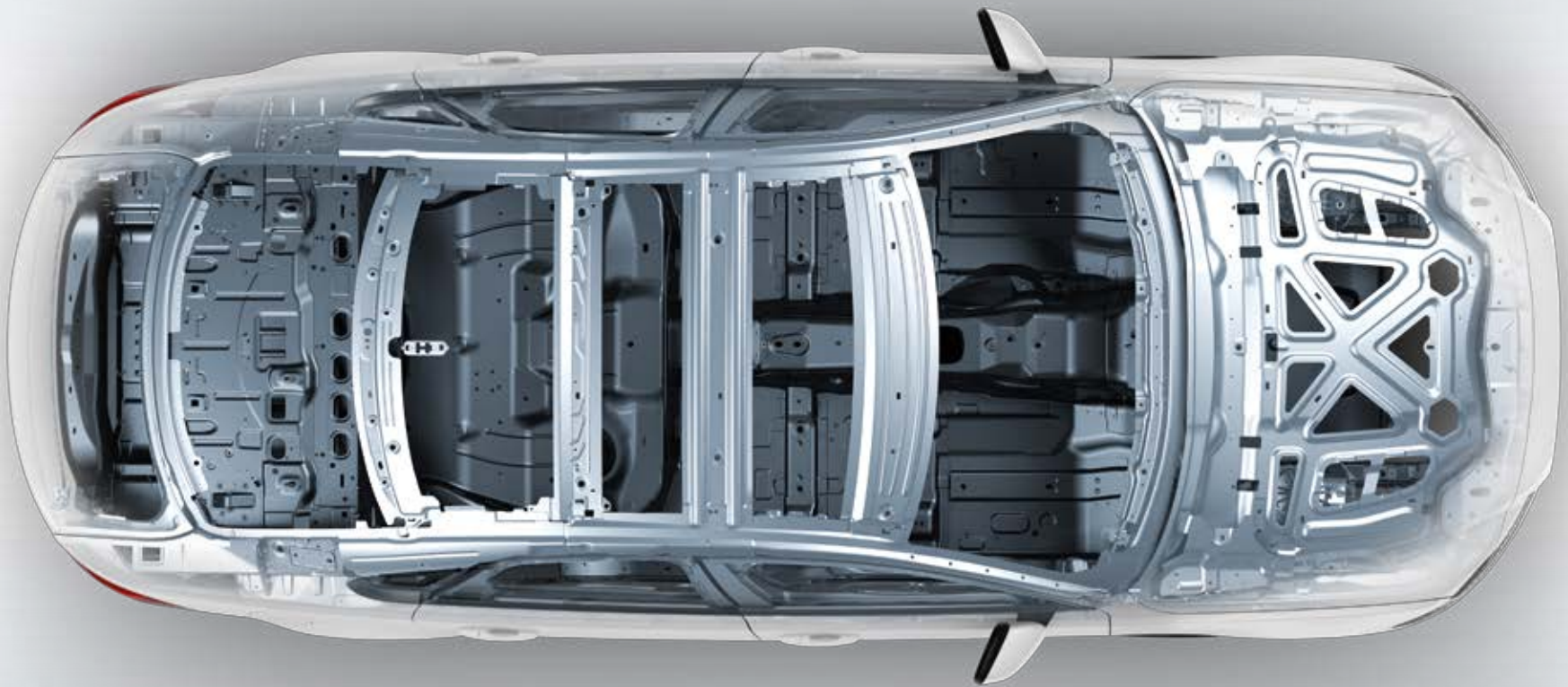

LIGHTWEIGHT ALUMINUM ARCHITECTURE

 **STRONG** | **RIGID** | **75% ALUMINUM**

Jaguar has been at the forefront of aluminum car construction for more than a decade. The latest innovation is our high-strength Lightweight Aluminum Architecture, which is strong and reduces weight, it is also stiff - underpinning the precise, agile handling of the Jaguar XF. Aluminum has also been used to form the body sides, hood and front wings. These panels are bonded together with a strong adhesive, then punched with zinc-coated, boron steel rivets that compress the adhesive to form an airtight bond and a strong, rigid structure. This cutting-edge process, coupled with the Lightweight Aluminum Architecture, contributes towards a weight saving of up to 265 lbs over the previous generation Jaguar XF.

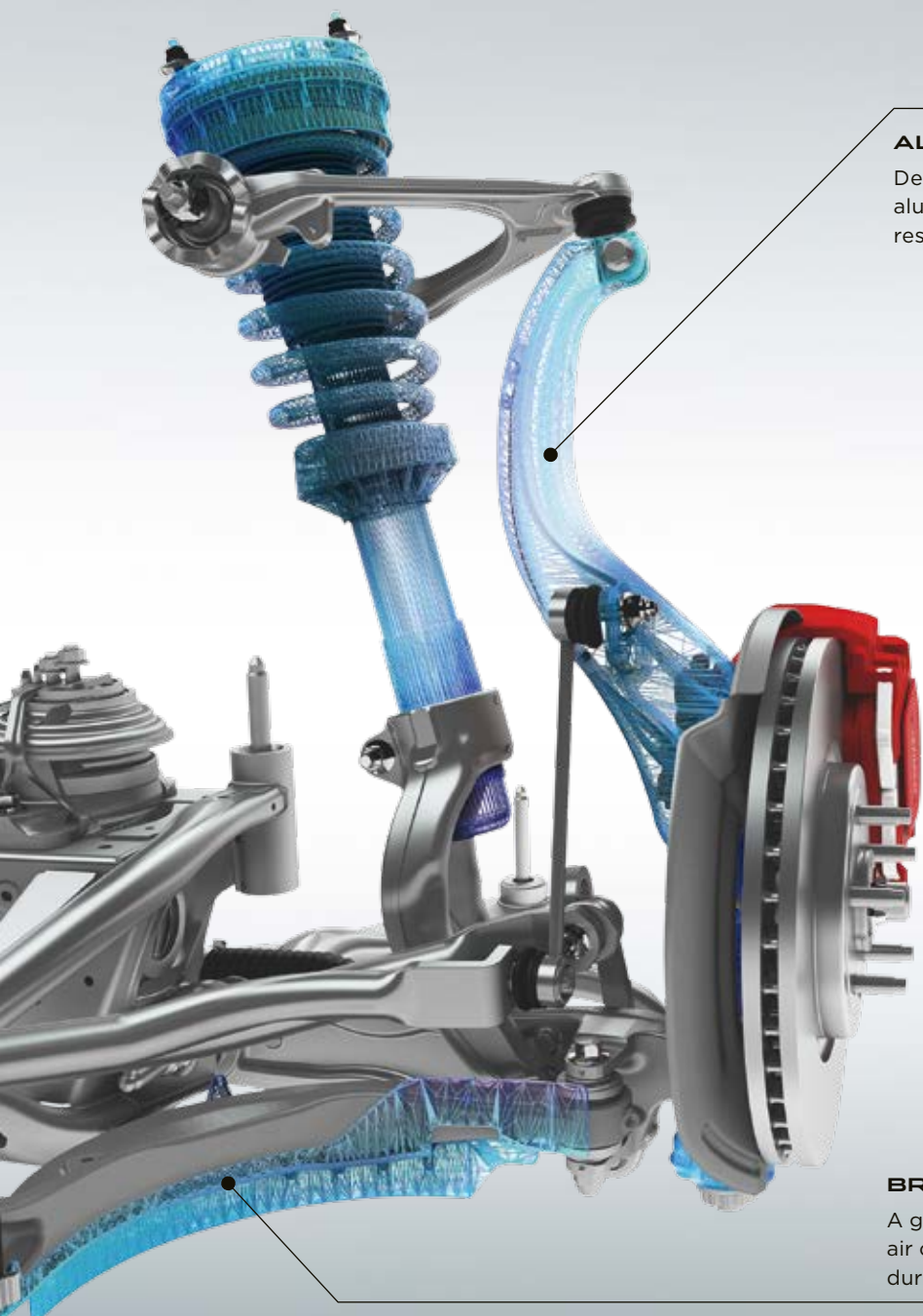

ALUMINUM FRONT KNUCKLE

Designed to optimize stiffness and strength, the lightweight aluminum front knuckle helps improve the Jaguar XF agility, responsiveness and refinement for sports car-like control.

CHASSIS AND SUSPENSION



ADVANCED SUSPENSION
TECHNOLOGY

COMFORTABLE
AND DYNAMIC

The Jaguar XF responds with agility and performs with dynamism while maintaining ride comfort – it's a unique balance that makes it a Jaguar. The ideal foundation for these driving dynamics is the light, yet strong and stiff, Lightweight Aluminum Architecture with its near 50:50 weight distribution.

The sophisticated front and rear suspension systems complete a chassis that achieves a superb combination of sportiness and refinement. Advanced damper technologies – both passive or adaptive – improve ride quality still further and extend the Jaguar XF breadth of dynamic capabilities. The suspension control, agility and feedback give the Jaguar XF the spirit of a sports car.

BRAKE SCOOP

A glass-filled polypropylene brake scoop channels air onto the brakes for enhanced brake performance during enthusiastic driving.

INTEGRAL LINK REAR SUSPENSION

Integral Link suspension allows the Jaguar XF to realize an ideal combination of refined, luxurious ride and sharp, responsive handling. The system separates and independently manages the lateral, longitudinal and vertical forces acting on the suspension for enhanced control and comfort. Many components are forged or hollow-cast aluminum – the optimum production techniques for strong, lightweight suspension.

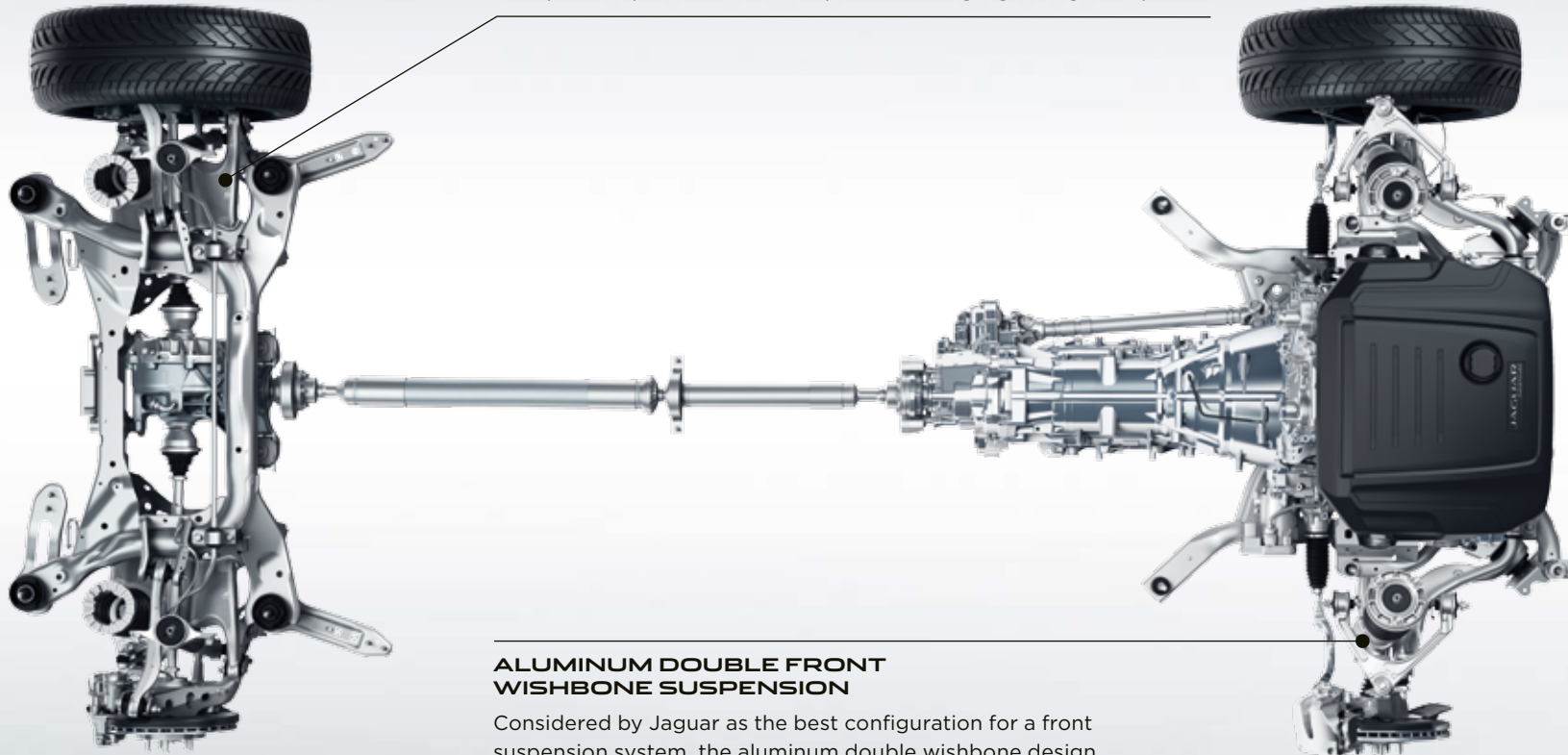

ALUMINUM DOUBLE FRONT WISHBONE SUSPENSION

Considered by Jaguar as the best configuration for a front suspension system, the aluminum double wishbone design is modeled closely on the F-TYPE for precise handling and steering response.

DRIVING TECHNOLOGY

ADVANCED DRIVING DYNAMICS

> ENHANCING AGILITY

Dynamic Mode revises the software of the vehicle to further enhance the sporting character. It sharpens the throttle response, increases steering weighting and performs gearshifts more quickly and at higher engine speeds. It also brings visual drama to the driver as the instrument cluster takes on a red glow. Dynamic Mode enhances your connection with the Jaguar XF inherent Jaguar performance.

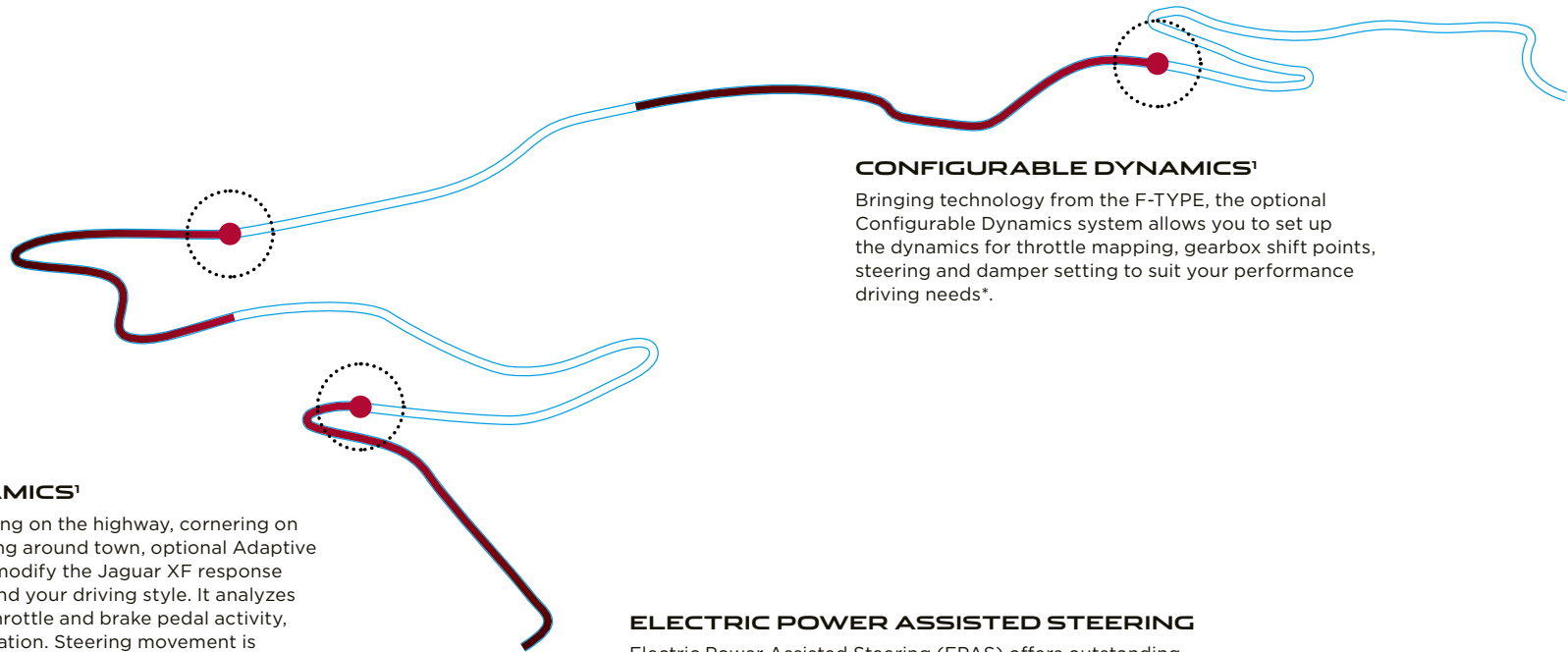

ADAPTIVE DYNAMICS¹

Whether you're accelerating on the highway, cornering on country roads or navigating around town, optional Adaptive Dynamics is designed to modify the Jaguar XF response to match the conditions and your driving style. It analyzes acceleration, cornering, throttle and brake pedal activity, as well as kick down activation. Steering movement is analyzed up to 500 times a second and body movement up to 100 times a second. Using this information, electronically controlled adaptive dampers then constantly adjust the suspension settings and maintain the poise and comfort of the Jaguar XF*.

CONFIGURABLE DYNAMICS¹

Bringing technology from the F-TYPE, the optional Configurable Dynamics system allows you to set up the dynamics for throttle mapping, gearbox shift points, steering and damper setting to suit your performance driving needs*.

ELECTRIC POWER ASSISTED STEERING

Electric Power Assisted Steering (EPAS) offers outstanding feedback, control and immediate power assistance. The EPAS sophisticated computer management varies steering assistance as appropriate - increasing assistance for low speed maneuvering and improving feel at higher speeds. It also enables advanced driver assistance features such as Lane Keep Assist and Park Assist*.

*These features are not a substitute for driving safely with due care and attention and will not function under all circumstances, speeds, weather and road conditions, etc. Driver should not assume that these features will correct errors of judgment in driving. Please consult the owner's manual or your local Jaguar Retailer for more details.

¹Standard on Jaguar XF S and Jaguar XF Sportbrake S.



ADDED DRIVER ASSURANCE



ALL SURFACE PROGRESS CONTROL

ADAPTIVE SURFACE RESPONSE

All Surface Progress Control (ASPC) technology is a low speed cruise control that helps the Jaguar XF to cope with low traction situations. ASPC allows the driver to concentrate on steering the vehicle. Once activated, use the cruise control buttons to set a 'target' speed between 2.2 mph and 18.6 mph. The system then works to achieve and maintain that speed while exerting traction control*.

ASPC is standard and gives Jaguar XF drivers added assistance over slippery, loose surfaces, undulating terrain and even while descending a difficult incline. It helps make the Jaguar XF easier to drive in challenging conditions. ASPC also has a pull-away function allowing the vehicle to progress from rest on low grip surfaces and ascending gradients, as well as a hill descent function that controls vehicle speed on steeper inclines*.

On the Jaguar XF S AWD and the Jaguar XF Sportbrake S, Adaptive Surface Response (AdSR) is designed to recognize differences between surfaces to exploit the maximum available grip. AdSR constantly monitors the car's environment and adjusts the appropriate engine and brake settings. Once selected, AdSR works at all speeds to support you in adverse weather and across challenging surfaces*.



GRAVEL

*These features are not a substitute for driving safely with due care and attention and will not function under all circumstances, speeds, weather and road conditions, etc. Driver should not assume that these features will correct errors of judgment in driving. Please consult the owner's manual or your local Jaguar Retailer for more details.



WET GRASS



SNOW/ICE



WET ROAD



HBS 991

XF

ADVANCED DRIVETRAIN TECHNOLOGY



ALL WHEEL DRIVE

INTELLIGENT DRIVELINE DYNAMICS

The Jaguar XF All Wheel Drive (AWD) system combines the agility and character of Rear Wheel Drive (RWD) with the increased traction provided by AWD. In normal driving, the Jaguar XF is predominantly RWD to deliver handling purity, feel and balance. But when roads become more challenging, or when you accelerate more swiftly on low-grip surfaces, the system is designed to subtly channel power forwards enabling the Jaguar XF to maintain improved traction for comfortable progress in various conditions*.

The Jaguar XF AWD uses a transfer case at the back of the 8-speed Automatic Transmission to manage the appropriate distribution of torque to the front and rear wheels. Engineered to ensure that the Jaguar XF retains the dynamic behavior of a Jaguar car, the transfer case contains an electro-mechanically activated multi-plate clutch with an actuator to build hydraulic pressure. This pressure is quickly and accurately controlled to generate the required force in the clutch to transfer the optimal amount of torque to the front wheels.

Unlike other systems that react to wheel slip, Jaguar's Intelligent Driveline Dynamics (IDD) software is predictive and uses sensors measuring throttle and steering inputs to anticipate wheel slip*. IDD seamlessly co-ordinates these inputs and compares them with responses from the engine, transmission and traction control systems to calculate the traction available and distribute torque accordingly even before grip is lost. From a standstill, the Jaguar XF can transition from RWD to AWD in milliseconds. The result is a drive which blends the character of RWD with the capability of AWD, providing enhanced levels of performance and control*.

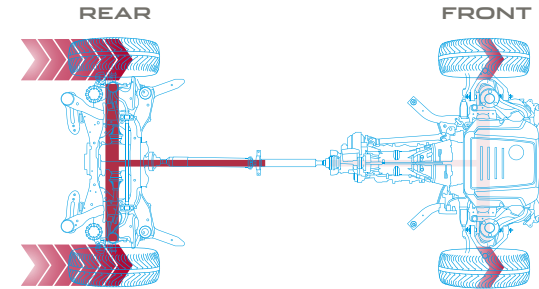

DRY ROAD CONDITIONS

In normal conditions, torque is distributed to the rear wheels, delivering acclaimed Jaguar agility and handling.

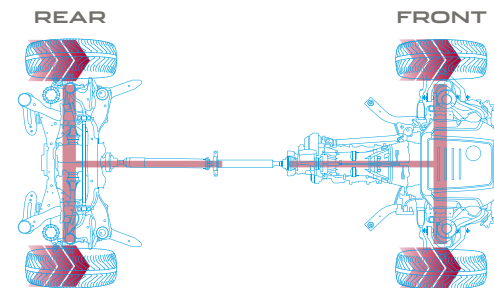

LOW TRACTION CONDITIONS

On slippery surfaces, such as grass or snow, torque can be balanced between the front and rear wheels to improve traction. In extreme conditions where only the front wheels have traction, up to 100 percent of engine torque can be distributed to the front wheels for more optimal grip.

*These features are not a substitute for driving safely with due care and attention and will not function under all circumstances, speeds, weather and road conditions, etc. Driver should not assume that these features will correct errors of judgment in driving. Please consult the owner's manual or your local Jaguar Retailer for more details.

VEHICLE SHOWN: JAGUAR XF SEDAN S IN YULONG WHITE WITH OPTIONAL EQUIPMENT



TORQUE VECTORING

> ENHANCED CORNERING CAPABILITY

Torque Vectoring is designed to improve capability through even the tightest corners. Torque Vectoring technology provides controlled independent braking on the individual inside front and rear wheels to add to the turning forces acting on the car. In most conditions more braking pressure is applied to the rear inside wheel as this supports increased cornering capability, while the front inside wheel is braked for greater effectiveness and refinement. The result is reduced understeer for sharper turning and more consistent road holding. Torque Vectoring delivers increased sports car-like agility and added driver assistance*.

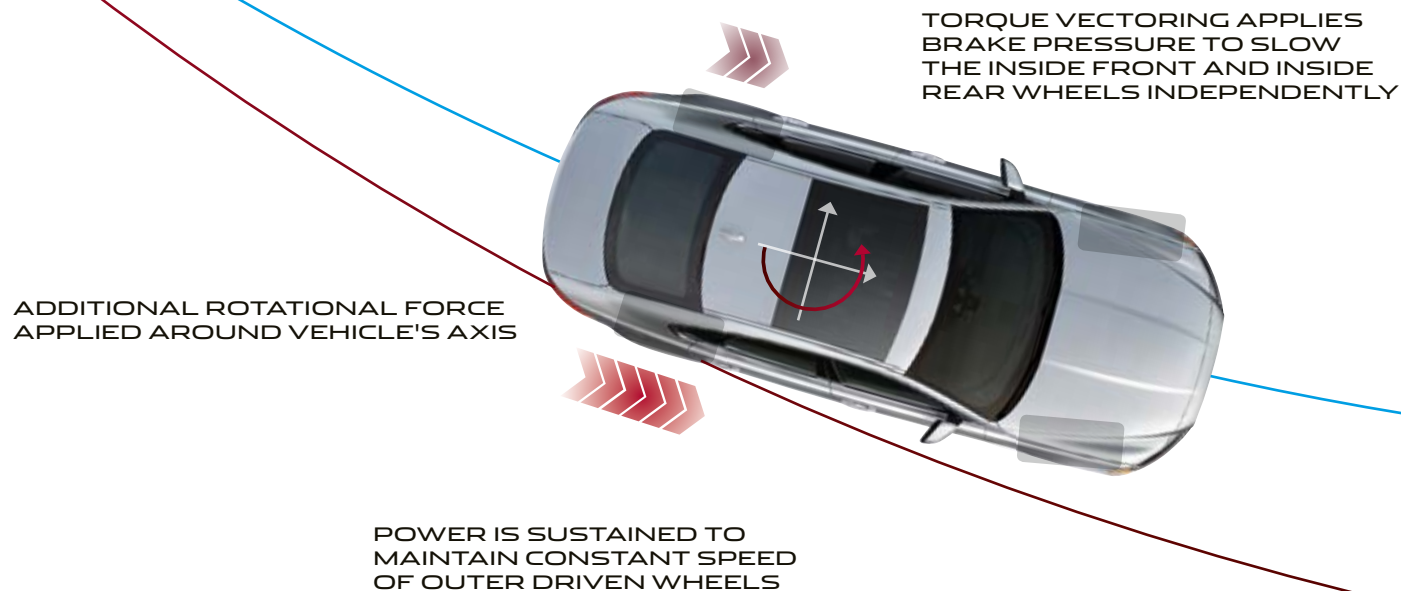

*These features are not a substitute for driving safely with due care and attention and will not function under all circumstances, speeds, weather and road conditions, etc. Driver should not assume that these features will correct errors of judgment in driving. Please consult the owner's manual or your local Jaguar Retailer for more details.

VEHICLE SHOWN: JAGUAR XF SEDAN S IN YULONG WHITE WITH OPTIONAL EQUIPMENT



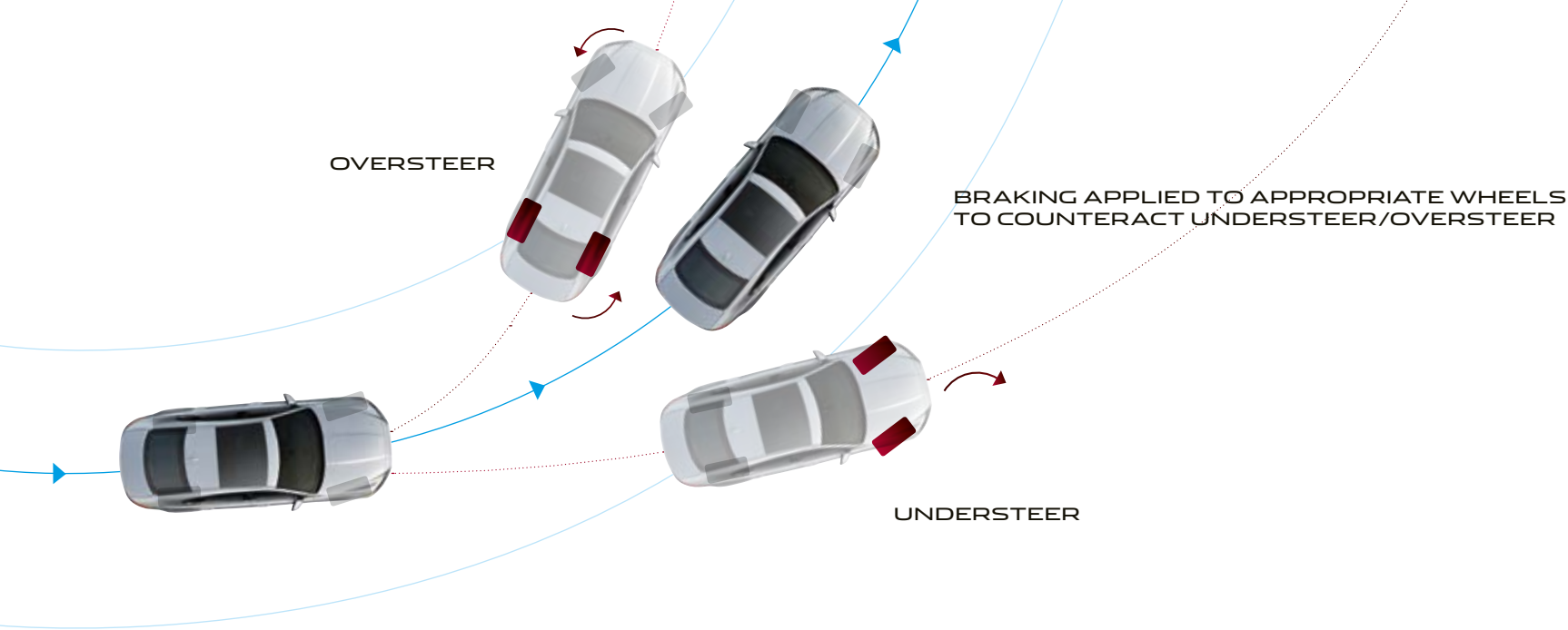

STABILITY AND CONTROL



DYNAMIC STABILITY CONTROL

ENGINE DRAG TORQUE CONTROL

The stability systems are designed to keep the Jaguar XF balanced whether you're driving enthusiastically or simply want some reassurance in challenging conditions.

Dynamic Stability Control (DSC) monitors the dynamic behavior of the Jaguar XF, intervening to assist vehicle stability and improving available grip. DSC is designed to reduce engine torque and apply braking to the appropriate wheels to correct the car direction of travel by counteracting understeer or oversteer. The DSC system fitted to the Jaguar XF has enhanced understeer control to reduce speed and help regain control more effectively*.

Engine Drag Torque Control mitigates the chance of wheel lock-up caused by strong engine braking in slippery conditions. It acts by briefly increasing torque to the driven wheels as appropriate*.

*These features are not a substitute for driving safely with due care and attention and will not function under all circumstances, speeds, weather and road conditions, etc. Driver should not assume that these features will correct errors of judgment in driving. Please consult the owner's manual or your local Jaguar Retailer for more details.

Graphical representation only.

VEHICLE SHOWN: JAGUAR XF SEDAN S IN YULONG WHITE WITH OPTIONAL EQUIPMENT



Darkness
Oliver Baldy
Darkness
6/12



HOME 14:56

Navigation Arlington Avenue Leamington Spa 65 mi 16:55	Media Bluetooth audio Young Before Your Time Corvidae	Phone My iPhone
---	--	--------------------

Navigation icons: Home, Back, Forward, Search, Phone, Bluetooth, App Store, Play Store, CarPlay, Siri.

68°F 71°F

SYNC, WIPER, FOG, HORN, TRIP, AUTO

MAX, MAX A/C, A/C

START/STOP, ENGINE STOP

P R N D S

DRIVE MODE SELECTOR

DRIVE MODES: OFF, SPORT, RACE, WET, SLIP CONTROL OFF, SLIP CONTROL ON

TECHNOLOGY INFOTAINMENT

Delivering a wealth of information and entertainment, every Jaguar XF is equipped with our Jaguar InControl® infotainment system, Touch Pro. It features intuitive and advanced integrated technologies to ensure everyone can make the most of their trip*.



10" TOUCH PRO*

The standard 10" Touchscreen at the heart of the center console supports swipe and pinch gestures and delivers our richest ever audio-visual entertainment. To enhance the in-car experience, Touch Pro offers customizable homescreens and fast response times as well as voice control. Multi-tasking is also made easy thanks to the Interactive Side Panel. Touch Pro is further enhanced by adding the connectivity package, Connect Pro¹.



INTERACTIVE DRIVER DISPLAY

The optional 12.3" high-definition Interactive Driver Display¹ can receive and project a vast amount of driving information, entertainment and driver assistance data including navigation, phone and media. Its high resolution ensures the utmost clarity and its refined processing engine delivers smooth moving pin graphics. To help you find your way more easily, the option of Navigation Pro² enables you to display fullscreen navigation with 3D mapping**.

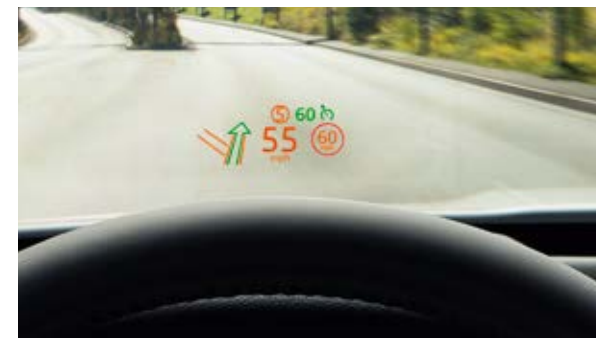

HEAD-UP DISPLAY

Minimizing distractions and the need to take your eyes off the road, Head-up Display³ is an option that presents key vehicle data such as your speed, gear position and navigation directions on the windshield. It features crystal clear full-color graphics in high resolution, enabling you to see all driver inputs and information with ease[†]. It can display important information from the Touch Pro Touchscreen and your phone. The feature can be turned on and off dependent on driver preference.

*Do not use Jaguar InControl® features under conditions that will affect your safety or the safety of others. Driving while distracted can result in loss of vehicle control. **Driving while distracted can result in loss of vehicle control. Do not operate, adjust or view the navigation or multimedia systems under conditions that will affect your safety or the safety of others. Only use mobile phones, and other devices, even with voice commands, when it is safe to do so. †These features are not a substitute for driving safely with due care and attention and will not function under all circumstances, speeds, weather and road conditions, etc. Driver should not assume that these features will correct errors of judgment in driving. Please consult the owner's manual or your local authorized Jaguar Retailer for more details.

¹Requires Navigation Pro. ²Requires Connect Pro package. ³Requires Solar attenuating windshield to be fitted.

Information and images displayed in relation to the InControl technology, including screens or sequences, are subject to software updates, version control and other system/visual changes depending on options selected. Mobile network connectivity cannot be guaranteed in all locations. InControl Apps and Remote App will need to be downloaded from the Apple/Play Store.

CONNECTIVITY

Jaguar InControl® is our suite of standard and optional features that connects you to your vehicle and links you seamlessly with the outside world. There are a variety of packages and options available to choose from. With a selection of apps, even when you're away from your car, some of the InControl features stay with you.

STANDARD FEATURES

PINPOINT TOUCH CONTROL*

Pinpoint touch control allows you to interact with information swiftly. The Touchscreen responds in the same manner as a smartphone or tablet computer, providing multi-touch gestures such as pinch to zoom and swipe.

PERSONALIZED HOMEPAGE*

You can set up your homescreens the way you want them. With over 60 shortcuts and widgets, you can customize your system around the features you use most.

INTERACTIVE SIDE PANEL*

A choice of side panels means you can multi-task. For example, your main screen area can be used for navigation, while the side panel provides phone controls. Simply swipe up and down to switch between multiple panels.

MULTIMEDIA*

Enjoy a variety of multimedia features on the Touchscreen. Connect your device and see details of playlists and music displayed by artist, album and genre.

ENHANCED PHONE INTERFACE*

Making it easier, you can call a favorite contact with a single touch via the customizable homepage. Additional functionality includes direct access to voicemail, conference calling and homescreen integration.

VOICE RECOGNITION SYSTEM*

Complete tasks without taking your eyes off the road. The XF offers intelligent voice recognition. For example, 'Tune to 97.9' or 'Call home'.

*Do not use Jaguar InControl® features under conditions that will affect your safety or the safety of others. Driving while distracted can result in loss of vehicle control. Information and images displayed in relation to the InControl technology, including screens or sequences, are subject to software updates, version control and other system/visual changes depending on options selected. Mobile network connectivity cannot be guaranteed in all locations. InControl Apps and Remote App will need to be downloaded from the Apple/Play Store.



PROTECT

Jaguar Optimized Assistance - You can make a direct call to the Jaguar Assistance team by pressing the button on the overhead console or from the Assistance screen within the InControl Remote smartphone app.

SOS Emergency Call - Emergency services will be automatically notified if the airbags are deployed in an accident. For peace of mind, this service is provided for the first ten years from date of registration.

- **Remote Lock/Unlock** - Lock or unlock your doors remotely. Simply press the 'lock' button on the Vehicle Security screen of the Remote smartphone app to single lock the doors and fold in the side mirrors¹. Press the 'unlock' button to open your vehicle, unfold the side mirrors, turn on the dipped headlights and cause the hazard lights to flash twice to help you locate your vehicle.

- **Remote Climate** - Prepare your Jaguar XF in advance by pre-heating or pre-cooling the cabin, so that you and your passengers are comfortable from the moment you step inside.

- **Beep/Flash** - This feature turns on your Jaguar's hazard lights, dipped headlights and sounds an audible alert to help you locate your vehicle.

Remote - Remote smartphone app provides information on your vehicle and enables you to interact with it remotely. Compatible with most smartphones, Android Wear™ or the Apple Watch®, this service includes:

- **Journeys** - This opt-in feature can automatically record your trip history including your route and mileage statistics. This information can be exported by email to use for expense reporting and can be imported to a spreadsheet.

- **Vehicle Status Check** - Check current fuel level and range, and status of door and window position and locks. See the last parked location of the vehicle and find your way back to it with on-foot directions.

¹When power fold mirrors are specified.

OPTIONAL FEATURES

NAVIGATION PRO

Navigation Pro allows you to save your favorite places, use pinch and zoom gestures for simple map exploration and display a choice of either 2D or 3D crystal clear map graphics. Navigation Pro functionality is further enhanced by the Connect Pro Package*.

CONNECT PRO PACKAGE¹

Connect Pro, which is included with Navigation Pro, consists of a 4G Wi-Fi Hotspot** and Pro Services. It's designed to enhance your in-car and out-of-car experience ensuring you and your passengers enjoy the journey while remaining connected to the world*.

INCONTROL APPS

Jaguar InControl Apps technology allows vehicle-optimized apps on your Android™ or Apple® smartphone to be controlled through the vehicle's Touchscreen, including contacts, calendar and music player via a USB cable. You can also download third-party apps offering a variety of services*.

- **Spotify²** – Access a library of more than 30 million songs with this seamlessly integrated app. Featuring all the same intuitive functionality as the Spotify smartphone app, you can search songs, stations and recommendations, create playlists and access your music in offline mode. Simply log in using your existing Spotify Free or Spotify Premium account.
- **Tile³** – Helps you find lost or misplaced items in seconds. Attach a tiny Bluetooth tracker Tile to your keys, wallet or bag. The easy-to-use Tile app can then help you find these items should they be misplaced. The app is accessible any time through your vehicle's Touchscreen, allowing you to make sure you have everything you need with you, before you set off on your journey*.

4G Wi-Fi

The 4G Wi-Fi Hotspot provides in-car access to the Internet, enabling up to eight wireless devices to be used simultaneously in the car. Passengers can connect through the vehicle's wireless network to surf, work, update social media and stay entertained throughout the trip**.

PRO SERVICES

- **Real Time Traffic Information** – Uses live traffic data feeds to give you the most accurate picture of what the traffic is like on the way to your destination*.
- **One-box Search** – Wherever you are, you can search the surrounding area for places of interest. The system can access expert destination information, travel tips and inspiration as well as online travel reviews of the local area*.
- **Planning Routes and Door-to-Door Routing** – Before setting off, use the Route Planner app or online to search, save locations or set your destination. The app uses the Cloud to send your destination automatically to your vehicle's navigation screen. Once you've parked, the Route Planner app will guide you to your destination – a true door-to-door experience which includes public transportation options*.
- **Share ETA** – You can share your estimated time of arrival so your selected contact(s) will know exactly when you will arrive, as calculated by the navigation guidance system. If you're running late, Share ETA can then send automatic updates via text messages or email, without any further action from you*.

*Do not use Jaguar InControl® features under conditions that will affect your safety or the safety of others. Driving while distracted can result in loss of vehicle control. **The Wi-Fi Hotspot is intended for passenger use only. InControl features may require an additional subscription with separate terms and conditions.

¹Requires Navigation Pro. ²Please check App Store and Google Play for availability. ³Bluetooth tracker tiles must be purchased separately. 2016 Tile Inc. and the Tile design are trademarks of Tile, Inc.

Information and images displayed in relation to the InControl technology, including screens or sequences, are subject to software updates, version control, and other system/visual changes depending on options selected. Mobile network connectivity cannot be guaranteed in all locations. InControl Apps and Remote App will need to be downloaded from the Apple/Play Store.

- **Satellite View** – When you want to get the context of your surroundings from overhead, simply switch to satellite view*.
- **Commute Mode** – Allows the system to learn your commutes and automatically advises you of the expected travel time based on live and historical traffic movements without you having to input a destination. The system learns the routes you take for a given destination and then advises which of those is the quickest. The feature can be turned on and off dependent on driver preference.
- **Parking Service** – As you approach your destination, you can see where parking is available. Simply tap on the parking and the navigation system updates to direct you to it*.
- **Online Routing** – While you're on your way to a destination the system monitors live traffic conditions and takes into account typical traffic patterns for that time of day, keeping you on the optimum route.
- **Fuel Prices** – When you're going to fill up, the Fuel Price service not only finds gas stations along your route, it also enables you to compare fuel prices so you can keep your costs down.



Information and images displayed in relation to the InControl technology, including screens or sequences, are subject to software updates, version control and other system/visual changes depending on options selected. Mobile network connectivity cannot be guaranteed in all locations. InControl Apps and Remote App will need to be downloaded from the Apple/Play Store.

AUDIO

A vehicle's cabin is the ideal place within which to experience your personal choice of music and the Jaguar XF has the option of three different audio systems to bring your music to life:



MERIDIAN™ SOUND SYSTEM

Great definition, crystal clear highs and full, deep bass – delivered through the careful arrangement of 10 speakers and a dual channel subwoofer.

MERIDIAN SURROUND SOUND SYSTEM

All the fullness and clarity of a live performance delivered through an arrangement of 16 front, side and rear speakers and a dual channel subwoofer – seamlessly brought together using Trifield™ technology. Exclusive to Meridian, Trifield perfectly blends the center and surround channels with left and right channels ensuring an optimum, consistent sound experience for each passenger.

SIRIUSXM® SATELLITE RADIO* AND HD RADIO™







SiriusXM® Radio and HD Radio technology offers improved sound quality, and a wide choice of stations and entertainment*.

Image is representative of Meridian Surround Sound System.

*A 3-month trial subscription to the Sirius All Access package is included with the vehicle, which gives you access to 150+ channels of premium programming. Plus you can stream SiriusXM on your computer, smartphone or tablet – it's included in your trial. If you decide to continue service after your trial, the subscription plan you choose will automatically renew thereafter and you will be charged according to your chosen payment method at then-current rates. Fees and taxes apply. To cancel you must call SiriusXM at 1-866-635-2349. See the SiriusXM Customer Agreement for complete terms at siriusxm.com. All fees and programming are subject to change. SiriusXM Satellite Radio is not available in Alaska or Hawaii.

MERIDIAN

Formed in 1977 in Cambridgeshire, England, Jaguar's audio partner Meridian has pioneered many firsts including active speakers and the world's first digital surround sound processor. Meridian's audio technology input has helped ensure that the Jaguar XF is one of the most superb spaces. Meridian Cabin Correction technology was utilized to analyze cabin shape, acoustics and resonance characteristics in order to help remove unwanted sounds. The advanced algorithm ensures that the rhythm, punch and timing of any piece of music are heard precisely how the artist intended, providing a consistently exceptional quality audio experience for all passengers in the vehicle.

	UNIQUE MERIDIAN TECHNOLOGY	SPEAKERS + SUBWOOFER	WATTS
MERIDIAN™ SOUND SYSTEM	  	10+1	380
MERIDIAN™ SURROUND SOUND SYSTEM	   	16+1	825



DIGITAL SIGNAL PROCESSING

Brings all elements of the audio system together as one, for performance that would otherwise require significantly larger speakers.



MERIDIAN CABIN CORRECTION

The advanced algorithm of Meridian's Cabin Correction tailors the sound experience to the precise acoustics of the Jaguar XF interior.



MERIDIAN DIGITAL DITHER SHAPING

To maintain the quality of musical recordings, they are converted into a common digital format. Meridian Digital Dither Shaping ensures that digital signal conversions are made smoothly and seamlessly, preserving the finest details of the audio performance. The result is authentic musical conversion, evoking the emotions of the original recording.



TRIFIELD

Exclusive to Meridian, Trifield blends the center and surround channels seamlessly with left and right channels, delivering a consistent, concert-like experience for all occupants.

DRIVER ASSISTANCE¹

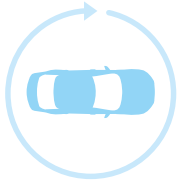

360° SURROUND CAMERA^{2,3}

Helping with various maneuvers, from parking by a curb to getting in and out of tight spaces or intersections, Surround Camera System gives you 360° exterior vision on the Touchscreen. To enhance this system further, new Forward Vehicle Guidance and Forward Traffic Detection are also available. Forming part of the Surround Camera System, Forward Vehicle Guidance provides the driver with an on-screen visualization of the vehicle and parking distance. Forward Traffic Detection helps avoid potential collisions in situations where forward maneuvers involve restricted views*.



REAR CAMERA³

Rear Camera is designed to provide improved visibility when reversing. This valuable parking aid also helps when hitching a trailer. Static lines representing the vehicle's outer perimeter and predicted path are superimposed on the rearward image, to make parking in tight spots as easy as possible*.

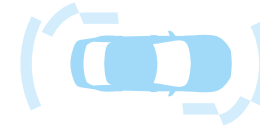

360° PARKING AID

360° Parking Aid uses ultrasonic sensors to the front, rear and sides of the vehicle, designed to alert you to the proximity of objects when parking or exiting from a parking space*.



EMERGENCY BRAKING³

Should a potential collision be detected, the Jaguar XF gives an audible forward collision warning. Visual warnings follow. If the driver takes no action the system is designed to apply the brakes** to help reduce the severity of the possible impact*.



PARK ASSIST

Park Assist makes parking in tight spaces easier than ever. The Jaguar XF can accurately steer itself during both parallel and perpendicular parking maneuvers - the driver only has to control the brakes and accelerator. An exit-assist function can help guide the Jaguar XF while leaving a parallel space*.



TRAFFIC SIGN RECOGNITION AND ADAPTIVE SPEED LIMITER

Traffic Sign Recognition (TSR) technology detects speed limits, including variable limits, and no passing signs via the forward-facing camera, then displays them to the driver. The Adaptive Speed Limiter uses TSR's information, supported by map data from the navigation system, to help keep the Jaguar XF within the appropriate speed limit*.

*These features are not a substitute for driving safely with due care and attention and will not function under all circumstances, speeds, weather and road conditions, etc. Driver should not assume that these features will correct errors of judgment in driving. Please consult the owner's manual or your local Jaguar Retailer for more details.

**Please note that if any action is taken, even minimal steering, the Emergency Braking system will assume the driver resumed control of the vehicle and the system will automatically disengage.

¹Please refer to pages 58-63 for fitment requirements and availability.

²Requires power fold mirrors.

³Requires Rear Parking Aid.



BLIND SPOT ASSIST²³

Blind Spot Assist uses radar sensors to detect quickly approaching vehicles and, if necessary, the system can provide assistance in preventing foreseeable collisions. If your vehicle detects another car in your blind spot when you begin to change lanes, a small warning light illuminates in the corresponding side mirror and a steering torque encourages you to guide your vehicle away from the approaching vehicle*.

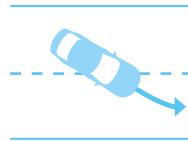

LANE DEPARTURE WARNING

The system senses when your vehicle is unintentionally drifting out of your lane, and notifies you with a visual alert and a gentle vibration of the steering wheel*.



LANE KEEP ASSIST AND DRIVER CONDITION MONITOR

Lane Keep Assist is designed to sense unintentional lane drift and to help steer the Jaguar XF back into its lane. Driver Condition Monitor is designed to detect lapses in concentration due to tiredness by monitoring driver inputs and suggests taking a break via an audible alert and a visual notification in the instrument cluster*.



REAR TRAFFIC MONITOR²³

Reverse Traffic Detection is particularly useful when reversing out of a parking space, the system is designed to warn you of vehicles, pedestrians or other hazards, approaching from either side of your vehicle. It will alert you with both audio and visual warnings so you know what's behind you even when the view is obstructed.



PEDESTRIAN DETECTION

Help protect the people outside your car as well as those inside. If the car makes contact with a pedestrian, the Pedestrian Contact Sensing system is designed to automatically raise the hood to help cushion a potential impact*.



ADAPTIVE CRUISE CONTROL WITH QUEUE ASSIST

Adaptive Cruise Control uses radar technology to automatically adjust your speed to maintain a set distance from the vehicle ahead. If that vehicle slows, your Jaguar XF reduces its speed to maintain a set distance. The Jaguar XF resumes its pre-set speed as soon as the road in front is clear. Should the car in front stop completely, the Queue Assist function is designed to help bring the Jaguar XF to a smooth halt. Once the traffic moves, touch the accelerator and the Jaguar XF will follow the car in front again*.

PERSONALIZATION THE JAGUAR XF - YOUR CHOICE

 Configure your vehicle at jaguarusa.com



CHOOSE YOUR ENGINE

Page 54

Select your Jaguar XF engine, to suit your driving style.

CHOOSE YOUR MODEL & OPTIONS

Page 56

Compare the wealth of standard features and options on the Jaguar XF models.

CHOOSE YOUR COLOR

Page 64

Express your individuality with one of the stunning exterior colors available on the Jaguar XF.

CHOOSE YOUR WHEELS

Page 66

Add the personal finishing touch to your new Jaguar XF, and complement its stunning style, with a set of beautifully designed alloy wheels.

CHOOSE YOUR INTERIOR

Page 68

There's a wide selection of premium materials, leathers, veneers and finishes for every personal taste.

CHOOSE YOUR JAGUAR GEAR

Page 80

Really make it yours by adding style, practicality and versatility with official Jaguar XF Gear Accessories from your local Jaguar Retailer.

1 CHOOSE YOUR ENGINE

 Configure your vehicle at jaguarusa.com

DIESEL ENGINE

2.0 LITER 4-CYLINDER TURBOCHARGED

XF SEDAN
MAXIMUM POWER 177HP
MAXIMUM TORQUE 318 lb-ft
ACCELERATION 0-60
RWD 7.9 seconds / AWD 8.0 seconds*
TOP SPEED RWD 142 mph / AWD 138 mph*
PREMIUM AND PRESTIGE



RWD 0-60 MPH



AWD 0-60 MPH



TOP SPEED MPH



TOP SPEED MPH

GAS ENGINES

2.0 LITER 4-CYLINDER TURBOCHARGED

XF SEDAN
MAXIMUM POWER 247HP
MAXIMUM TORQUE 269 lb-ft
ACCELERATION 0-60
RWD 6.4 seconds / AWD 6.3 seconds*
TOP SPEED RWD 152 mph / AWD 147 mph*
PREMIUM AND PRESTIGE



RWD 0-60 MPH



AWD 0-60 MPH



TOP SPEED MPH



TOP SPEED MPH

*Always follow local speed limits.

2.0 LITER

4-CYLINDER TURBOCHARGED

XF SEDAN

MAXIMUM POWER 296HP

MAXIMUM TORQUE 295 lb-ft

ACCELERATION 0-60

RWD 5.7 seconds / AWD 5.6 seconds*

TOP SPEED RWD 155 mph / AWD 155*

PREMIUM, PRESTIGE, PORTFOLIO

XF SPORTBRAKE

MAXIMUM POWER 296HP

MAXIMUM TORQUE 295 lb-ft

ACCELERATION 0-60

AWD 5.7 seconds*

TOP SPEED 155 mph*

PRESTIGE



RWD 0-60 MPH



AWD 0-60 MPH



AWD 0-60 MPH



TOP SPEED MPH



TOP SPEED MPH

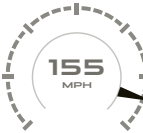

TOP SPEED MPH

3.0 LITER V6

SUPERCHARGED

XF SEDAN

MAXIMUM POWER 380HP

MAXIMUM TORQUE 332 lb-ft

ACCELERATION 0-60

AWD 5.0 seconds*

TOP SPEED 155 mph*

S

XF SPORTBRAKE

MAXIMUM POWER 380HP

MAXIMUM TORQUE 332 lb-ft

ACCELERATION 0-60 mph

AWD 5.3 seconds*

TOP SPEED 121 mph*

S



AWD 0-60 MPH



AWD 0-60 MPH



TOP SPEED MPH

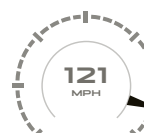

TOP SPEED MPH

2 CHOOSE YOUR MODEL

 Configure your vehicle at jaguarusa.com

LUXURY



PREMIUM

KEY FEATURES

- 18" Alloy Wheels
- Xenon headlights with LED signature DRL and heated power wash
- Luxtec seats
- 10-way front seats (8-way electric)
- Power adjustable steering column with memory
- Rear-folding seat (40/20/40 split)
- Meridian™ Sound System
- All Surface Progress Control (ASPC)
- Premium carpet mats
- Suedecloth headlining



PRESTIGE

KEY FEATURES (IN ADDITION TO PREMIUM)

- 19" alloy wheels
- Perforated grained leather seats
- Soft grain leather heated steering wheel
- Heated front seats with 4-way power lumbar
- Ambient Interior Lighting
- Keyless Entry
- Front and Rear Parking Aid*
- Navigation Pro**

SPORTBRAKE KEY FEATURES (IN ADDITION TO XF PRESTIGE SEDAN)

- Silver Roof Rails
- Integrated Roof Spoiler
- Rear Self Leveling Air Suspension
- Cargo Space Cover
- Powered Gesture Tailgate
- Stainless steel cargo space scuff plate

*These features are not a substitute for driving safely with due care and attention and will not function under all circumstances, speeds, weather and road conditions, etc. Driver should not assume that these features will correct errors of judgment in driving. Please consult the owner's manual or your local Jaguar Retailer for more details.

**Driving while distracted can result in loss of vehicle control. Do not operate, adjust or view the navigation or multimedia systems under conditions that will affect your safety or the safety of others. Only use mobile phones, and other devices, even with voice commands, when it is safe to do so.

> SPORT



PORTFOLIO

KEY FEATURES (IN ADDITION TO PRESTIGE)

Windsor leather 20-way electric front luxury seats with driver and passenger seat memory
Windsor leather wrapped instrument panel
Heated and cooled front seats with heated rear seats
Adaptive LED headlights with signature 'J' blade DRL and Auto High Beam Assist (AHBA)
Blind Spot Monitor and Reverse Traffic Detection*
Electric rear, manual side window sunblinds
InControl Touch Pro™ Navigation**
12.3" Interactive Driver Display
Meridian™ Surround Sound System
Head-up Display*
Powered Gesture Trunk Lid



S

KEY FEATURES

20" alloy wheels
'S' body kit including unique front sport bumper, Gloss Black side sills, rear valance and trunk mounted spoiler
Red brake calipers
18-way electric front sport-style seats
Perforated grained leather 'S' embossed seats with contrast stitching
Satin Grey Figured Ebony veneer
Dark Hex Aluminum instrument panel finisher
Multi-function steering wheel with 'S' branding
Adaptive Dynamics* and Configurable Dynamics

SPORTBRAKE KEY FEATURES (IN ADDITION TO XF S SEDAN)

Gloss Black Roof Rails
Integrated Roof Spoiler
Rear Self Leveling Air Suspension
Cargo Space Cover
Powered Gesture Tailgate
Stainless steel cargo space scuff plate

2 CHOOSE YOUR OPTIONS

 Configure your vehicle at jaguarusa.com

KEY STANDARD & OPTIONAL FEATURES	PREMIUM	PRESTIGE	PORTFOLIO	S
TRANSMISSION, STEERING & DYNAMIC FEATURES				
8-speed ZF electronic Automatic Transmission	●	●	●	●
Electric Power Steering (EPAS) with speed proportional steering*	●	●	●	●
Torque Vectoring*	●	●	●	●
Hill Launch Assist*	●	●	●	●
All Surface Progress Control (ASPC)*	●	●	●	●
Steering wheel mounted shift paddles	●	●	●	●
JaguarDrive Control™	●	●	●	●
Normal, Eco & Dynamic Modes	●	●	●	●
Rain/Ice/Snow Mode*	●	●	●	—
Adaptive Surface Response (AdSR) Mode* (XF S AWD model only)	—	—	—	●
JaguarDrive Selector™ rotary gear selector	●	●	●	●
SUSPENSION				
Four-wheel independent suspension	●	●	●	●
Double wishbone front suspension architecture	●	●	●	●
Integral link rear suspension	●	●	●	●
Rear Air Suspension Architecture	—	● ¹	—	● ¹
Adaptive Dynamics with Configurable Dynamics or Dynamic-i*	—	○	○	●
BRAKES & STABILITY CONTROL				
Anti-lock Braking System (ABS)*	●	●	●	●
Cornering Brake Control (CBC)*	●	●	●	●
Dynamic Stability Control (DSC) with Trac DSC Mode*	●	●	●	●
Electric Parking Brake (EPB) with drive-away release	●	●	●	●
Hazard lights under heavy braking	●	●	●	●

SAFETY & SECURITY	PREMIUM	PRESTIGE	PORTFOLIO	S
SAFETY				
Passive front head restraints (whiplash reduction system)	●	●	●	●
Seat belt-minder system with audio reminder chime and flashing warning light engages if vehicle is moving more than 10 mph and safety belt is not buckled on occupied front or rear seats	●	●	●	●
Driver and front passenger safety belt pretensioners	●	●	●	●
ISOFIX child seat tethered-anchorage	●	●	●	●
Dual-stage front airbags and seat-mounted side airbags for front occupants**	●	●	●	●
Full length side-impact curtain airbags** for front and rear	●	●	●	●
Three-point restraints at all seating positions	●	●	●	●
Tire Pressure Monitoring System (TPMS)	●	●	●	●
SECURITY				
Anti-theft engine immobilizer	●	●	●	●
Security system with perimeter alarm	●	●	●	●
Emergency phosphorescent release in trunk	●	●	●	●
Brake pad wear indicator	●	●	●	●
LOCKING				
2-stage unlock, Touchscreen programmable	●	●	●	●
Central locking with drive-away door locking (Touchscreen programmable)	●	●	●	●
Jaguar Smart Key System™ with emergency blade - provide remote locking/unlocking, access to trunk and activate panic alarm	●	●	●	●
Keyless Entry	○	●	●	●
Soft Door Close	—	P3	●	P3
Power gesture tailgate - power open/close	—	P3	●	P3
Power operated child locks	●	●	●	●
Global window close from exterior lock button	●	●	●	●
Valet function for glove box and trunk security	●	●	●	●

● Standard ○ Option — Not available

P1 Cold Climate Package P2 Vision Assist Package P3 Comfort & Convenience Package P4 Premium Interior Upgrade Package P5 Driver Assistance Package P6 Tech Package P7 Black Package P8 Connect Pro Package

*These features are not a substitute for driving safely with due care and attention and will not function under all circumstances, speeds, weather and road conditions, etc. Driver should not assume that these features will correct errors of judgment in driving. Please consult the owner's manual or your local Jaguar Retailer for more details. **Please remember that the safety belts in a vehicle constitute the primary protection system for driver and passengers in collisions. Airbags are not designed to deploy in all collisions. The airbag Supplemental Restraint System (SRS) is a supplement to the safety belts and is designed to work as a system with the safety belts. Although airbags provide additional protection, airbags without safety belts do not provide optimal protection in a crash. Always wear your safety belts. Children younger than 13 years old should always be properly restrained in a back seat, away from airbags. Never place an infant seat in the front seat.

¹Only available on XF Sportbrake.

DRIVERS AIDS*

	PREMIUM	PRESTIGE	PORTFOLIO	S
Cruise control	●	●	●	●
Automatic Speed Limiter. If Traffic Sign Recognition is fitted on the vehicle, the Adaptive Speed Limiter (ASL) replaces the Automatic Speed Limiter	●	●	●	●
Blind Spot Monitor and Closing Vehicle Sensing	P2	P2	●	●
Blind Spot Assist and Closing Vehicle Sensing	—	—	P5	P5
Rear Camera Parking Aid with guidance lines on display	●	●	●	●
Rear parking sensors with Touchscreen visual indicators	P2	●	●	●
Front parking sensors with Touchscreen visual indicators	P2	●	●	●
360° Surround Camera - 4 cameras for front, side and rear views with images shown on the Touchscreen	—	—	P5	P5
Park Assist - Parallel and Perpendicular Parking plus Parking Exit	—	—	P5	P5
360° Parking Aid - additional sensors to alert the driver to potential side impacts	—	—	P5	P5
Traffic Sign Recognition and Adaptive Speed Limiter (ASL) (ASL replaces the cruise control's Automatic Speed Limiter)	—	—	P5	P5
Adaptive Cruise Control (ACC) with Forward Alert, Queue Assist, Intelligent Emergency Braking and Follow Mode off (When ACC fitted, the front grille insert is Gloss Black)	—	—	P5	P5
Emergency Braking (uses forward facing camera)	P2	P2	●	●
Lane Departure Warning	P2	P2	—	—
Lane Keep Assist	—	—	●	●
Driver Condition Monitor	—	—	●	●
Head-up Display	—	○	●	○

CONVENIENCE FEATURES

	PREMIUM	PRESTIGE	PORTFOLIO	S
Approach illumination	●	●	●	●
Dual function trip computer in Driver Message Center	●	●	●	●
Outside temperature gauge	●	●	●	●
Lockable glove box	●	●	●	●
A/C ducts in glove box for cooling	—	—	●	P4
Garage Door Opener (HomeLink® System) - compatible three-channel garage-door/entry-gate opener	●	●	●	●
Keyless Push Button Start	●	●	●	●
Rain sensing, variable intermittent dual wipers	●	●	●	●
Shopping bag hook and luggage tie downs in trunk	●	●	●	●
Sunglasses holder in overhead console	●	●	●	●
Three 12V power sockets - center console box, rear of center arm rest and right hand trunk wall	●	●	●	●

2 CHOOSE YOUR OPTIONS

 Configure your vehicle at jaguarusa.com

EXTERIOR FEATURES		PREMIUM	PRESTIGE	PORTFOLIO	S
BODY EXTERIOR APPEARANCE					
Bumpers - Body-colored		●	●	●	●
Exhaust tips - Twin single sided		● ¹	● ¹	—	—
Exhaust tips - Dual bright		● ²	● ²	● ²	● ²
Front grille	Grained Black mesh insert with Bright Chrome surround	●	●	●	—
	Gloss Black mesh insert with bright chrome surround	—	—	P5	—
	Grained Black mesh insert with Satin Chrome surround	—	—	—	●
	Gloss Black mesh insert with Satin Chrome surround	—	—	—	P5
Window surround finishers	Gloss Black mesh insert with Gloss Black surround	—	—	—	P7
	Bright Chrome	●	●	●	—
	Gloss Black	—	—	—	●
Trunk plinth finisher	Bright Chrome	●	●	●	—
	Satin Chrome	—	—	—	●
Side power vents	Gloss Black	—	—	—	P7
	Bright Chrome	●	●	●	—
	Satin Chrome	—	—	—	●
Front bumper	Gloss Black	—	—	—	P7
	Sport style front bumper	—	—	—	—
Side sills	'S' Style Bumper	—	—	—	●
	Body Colored	—	—	—	—
Rear valance	Gloss Black	—	—	—	●
	Grained Black	●	●	●	—
Rear spoiler - Body-colored, trunk mounted		—	—	—	●
Full Length Gloss Black Roof Rails (only available on Jaguar XF Sportbrake)		—	—	—	●
Full Length Silver Roof Rails (Only available on XF Sportbrake)		—	●	—	—

EXTERIOR BADGING		PREMIUM	PRESTIGE	PORTFOLIO	S
Trunk left side - Nameplate		●	●	●	●
Center trunk lid - Leaper and Jaguar wordmark		●	●	●	●
Trunk right side	Powertrain badging '20d' with 20d models only	●	●	—	—
	Powertrain badging '25t' with 25t models only	●	●	—	—
	Powertrain badging '30t' with 30t models only	●	●	●	—
	'S' badging	—	—	—	●
Front grille - 'S' Script		●	●	●	●
	'AWD' badging with AWD models only	●	●	●	●
		—	—	—	●
BRAKE CALIPERS					
Red with 'Jaguar' script (word is in white)		—	—	—	●
ELECTRIC PANORAMIC ROOF					
Electric with tilt/slide one-touch operation and electric blind (only available on Jaguar XF Sedan)		●	●	●	●
Fixed Panoramic Roof (only available on Jaguar XF Sportbrake)		—	●	—	●
LIGHTS					
Xenon Headlights with LED Signature DRL and auto leveling		●	●	—	—
Adaptive LED headlights with Signature DRL		P2	P2	●	●
LED signature 'J' blades Daytime Running Lights		●	●	●	●
Headlight power wash		●	●	●	●
Adaptive Front Lighting*		P2	P2	●	●
Cornering Lights*		P2	P2	●	●
Auto High Beam Assist (AHBA)*		P2	P2	●	●
Partial Light Emitting Diode (LED) tail lights		●	●	●	●
MIRRORS & WINDOWS					
Exterior mirrors - body-colored, electrically adjustable, heated with clear side turn indicators		—	—	—	—
Exterior mirrors - body-colored, power folding, electrically adjustable, heated, auto-dimming with puddle lights and clear side turn indicators		●	●	●	●
Passenger side exterior mirror - dip in reverse		●	●	●	●

● Standard ○ Option — Not available

P1 Cold Climate Package P2 Vision Package P3 Comfort & Convenience Package P4 Premium Interior Upgrade Package P5 Driver Assistance Package P6 Technology Package P7 Black Package

*These features are not a substitute for driving safely with due care and attention and will not function under all circumstances, speeds, weather and road conditions, etc. Driver should not assume that these features will correct errors of judgment in driving. Please consult the owner's manual or your local Jaguar Retailer for more details.

¹Standard on 20d models. ²Standard on gas engine models.

INTERIOR FEATURES

	PREMIUM	PRESTIGE	PORTFOLIO	S
CLIMATE CONTROL				
Front deployable vents	●	●	●	●
Automatic A/C with solar sensing, mist sensing, air filtration and dual temperature control for driver and front passenger	●	●	—	●
Four-zone Climate Control with auto-recirculation and air ducts in glove box. (Four-zone fitment results in replacement of the center console storage with a tray)	—	—	●	P4
DOOR SILL FINISHERS				
Illuminated – Metal with Jaguar script	●	●	●	●
Metal with 'S' script	—	—	—	○
FOOTWELL RUGS				
Premium front and rear floor mats (with Nubuck edge and tonal twin-needle stitching)	●	●	●	●
GEAR SELECTOR				
JaguarDrive™ rotary gear selector – Bright Chrome finish	●	●	●	●
INTERIOR LIGHTING				
Overhead light console with JaguarSense™ Control	●	●	●	●
Switchgear and instrument cluster panel lighting, front and rear map lights, front footwell lights, trunk illumination and front and rear downlighters	●	●	●	●
Driver and front passenger sunvisors with illuminated vanity mirrors	●	●	●	●
Blue ambient interior lighting on front and rear door signature lines and front and rear door release	—	●	—	●
Glove box illumination	—	●	●	●
10 color configurable ambient lighting including door storage, console and instrument panel plus rear footwells illumination and front and rear puddle lights	—	—	●	P4
MIRRORS & WINDOWS				
Auto-dimming interior rear view mirror	●	●	●	●
Front and rear electric windows with one-touch open/close and anti-trap	●	●	●	●
Acoustic layer windshield	●	●	●	●
Solar attenuating front windshield glass	●	●	●	●
Heated rear window	●	●	●	●
Heated front windshield with timer. Includes heated windshield jets	○	○	○	○

WINDOW SUNBLINDS

	PREMIUM	PRESTIGE	PORTFOLIO	S
Electric rear window sunblind (not available on Jaguar XF Sportbrake)	—	—	●	P4
Manual rear side window blinds	—	—	●	P4

SEATING

10x10 way front seats with 8x8 electric movement – Fore/Aft (2), Cushion Height (2) & Tilt (2), Squab Recline (2) – plus manual Headrest Height (2)	●	●	—	—
14x14 way front seats with 12x12 electric movements – Fore/Aft (2), Cushion Height (2), Cushion Tilt (2) & Extension (2), Squab Recline (2), Bolster (2) plus manual Headrest Height (2)	—	—	—	●
16x16 way front seats with 14x14 electric movements – Fore/Aft (2), Cushion Height (2), Cushion Tilt (2) & Extension (2), Squab Recline (2), Bolster (2), headrests height (2) plus manual winged headrest	—	—	●	—
Front seats 4-way power lumbar	—	●	●	●
Sport-style front seats	—	—	—	●
3-stage heated front seats	P1	●	●	●
3-stage active ventilated heated and cooled front seats	—	P3	●	P3
3-stage heated rear seats	P1	P3	●	P3
Memory function with 3 settings for driver seat, exterior mirrors and steering wheel column	●	●	●	●
Front passenger seat memory	—	—	●	●
Rear folding seat (40/20/40 split)	●	●	●	●
Rear armrest with twin cupholders	●	●	●	●
Three rear headrests	●	●	●	●

STEERING WHEEL & CONTROLS

Soft grain leather steering wheel with Jaguar Sequential Shift™ paddles and remote controls for audio, cruise control, Bluetooth* wireless technology and JaguarVoice™	●	—	—	—
Soft grain leather sport steering wheel with Jaguar Sequential Shift™ paddles and remote controls for audio, cruise control, Bluetooth* wireless technology and JaguarVoice™	—	●	●	●
Heated steering wheel	P1	●	●	●
'S' script on steering wheel	—	—	—	●
Power adjustable steering column (reach and rake)	●	●	●	●
Three flash lane change/turn indicator	●	●	●	●

2 CHOOSE YOUR OPTIONS

 Configure your vehicle at jaguarusa.com

INTERIOR FEATURES CONTINUED

	PREMIUM	PRESTIGE	PORTFOLIO	S
INTERIOR TRIM				
Front center console with storage compartment ¹ , twin cupholders, auxiliary power socket and armrest	●	●	●	●
Luxtec seat trim	●	—	—	—
Perforated grained leather seat trim	—	●	—	—
Perforated grained leather seat trim with contrast stitch	—	—	—	●
Perforated Windsor leather seat trim	—	—	●	—
Luxtec-wrapped instrument panel	●	●	—	●
Windsor leather wrapped instrument panel topper	—	—	●	—
'S' embossing on front seats	—	—	—	●
Seat back map pocket - Net	—	●	●	●
INSTRUMENT PANEL FINISHERS				
Morse Code Aluminum	●	●	●	—
Dark Morse Code Aluminum	—	—	—	—
Dark Hex Aluminum	—	—	—	●
VENEER TRIM				
Gloss Black finish	●	●	—	—
Grey Figured Ebony	—	—	—	●
Gloss Burl Walnut ²	—	○	○ ²	—
Gloss Figured Ebony	—	—	●	○
Satin Burl Ash ²	—	—	○ ²	—
Satin Fine Line	—	—	—	○
Carbon Fiber finish ²	—	—	○ ²	○
Morzine headlining	○	○	—	○
Suedecloth premium headlining	●	●	●	●
Ebony headlining	—	—	—	●
Light Oyster headlining	●	●	●	—

INFORMATION, COMMUNICATION AND ENTERTAINMENT

	PREMIUM	PRESTIGE	PORTFOLIO	S
MULTIMEDIA				
Physical dials with 5" full color TFT-LCD display	●	●	—	●
12.3" Interactive Driver Display	P6	○	●	○
Touch Pro - 10" capacitive Touchscreen display with controls for audio, climate control, Bluetooth* and navigation*	●	●	●	●
ECO HMI - Includes Eco data analysis, Parasitic load monitor and Driver Eco rating	●	●	●	●
Meridian™ Sound System 380W with 11 speakers including 1 subwoofer	●	●	—	●
Meridian™ Surround Sound System plus Meridian Trifield Mode, 17 speakers including 1 subwoofer, separate DSP, Audyssey MultEQ and Meridian Cabin Correction	P6	○	●	○
Dynamic Volume Control	●	●	●	●
HD Radio™	●	●	●	●
Front media interface (USB & iPod*)	●	●	●	●
SiriusXM® Satellite Radio** (includes 3 months complimentary subscription)	○	○	●	●
InControl Apps™ enables use of optimized 3rd party smartphone apps installed on a phone through the vehicle Touchscreen*	P8	●	●	●
NAVIGATION				
InControl Touch Pro - Navigation system with 60GB Solid-State Drive (SSD) based mapping.	○	●	●	●
Bluetooth* wireless technology for cell phone and audio streaming†	●	●	●	●
TELEMATICS				
Protect - SOS Emergency Call, Jaguar Assistance Call and Stolen Vehicle Locator. Service complimentary for 5 years	●	●	●	●
Remote - Smartphone application for vehicle status (fuel level, security status, last parked, direction to vehicle), vehicle lock/unlock, A/C remote setting through engine start. Feature complimentary for 5 years	●	●	●	●
Wi-Fi Hotspot - 4G Hotspot - includes 3GB or 3 months (which ever comes first) complimentary data subscription**	P8	●	●	●

● Standard ○ Option — Not available NCO No cost option

P1 Cold Climate Package P2 Vision Package P3 Comfort & Convenience Package P4 Premium Interior Upgrade Package P5 Driver Assistance Package P6 Technology Package P7 Black Package P8 Connect Pro Package

*Do not use Jaguar InControl® features under conditions that will affect your safety or the safety of others. Driving while distracted can result in loss of vehicle control. **A 3-month trial subscription to the SiriusXM® All Access package is included with the vehicle, which gives you access to 175+ channels of premium programming. Plus you can stream SiriusXM® on your computer, smartphone or tablet - it's included in your trial. If you decide to continue service after your trial, the subscription plan you choose will automatically renew thereafter and you will be charged according to your chosen payment method at then-current rates. Fees and taxes apply. To cancel you must call SiriusXM® at 1-866-635-2349. See the SiriusXM® Customer Agreement for complete terms at siriusxm.com. All fees and programming are subject to change. SiriusXM® Satellite Radio is not available in Alaska, Hawaii, or Puerto Rico. †Driving while distracted can result in loss of vehicle control. Do not operate, adjust or view the navigation or multimedia systems under conditions that will affect your safety or the safety of others. Only use mobile phones, and other devices, even with voice commands, when it is safe to do so. ††The Wi-Fi Hotspot is intended for passenger use only. Jaguar InControl® features may require an additional subscription with separate terms and conditions. ‡These features are not a substitute for driving safely with due care and attention and will not function under all circumstances, speeds, weather and road conditions, etc. Driver should not assume that these features will correct errors of judgment in driving. Please consult the owner's manual or your local Jaguar Retailer for more details.

¹Not available with Four-zone Climate Control. ²Limited availability.

OPTION PACKAGES

		PREMIUM	PRESTIGE	PORTFOLIO	S	
	CODE					DESCRIPTION
Cold Climate Package (P1)	017CA	○	—	—	—	Heated front seats, heated rear seats, heated steering wheel, heated front windshield with heated washer jets
Vision Assist Package† (P2)	017EK	○	○	—	—	LED headlights with signature Daytime Running Lights, Adaptive Front Lighting with Auto High Beam Assist (AHBA), Front and Rear Parking Aid (standard on the Prestige model, included as part of Package on the Premium model), Emergency Braking, Lane Departure Warning, Blind Spot Monitor with Closing Vehicle Sensing and Reverse Traffic Detection
Comfort & Convenience Package (P3)	017EO	—	○	●	○	Cooled front seats, heated rear seats, Soft Door Close, Power open/close Gesture Tailgate
Premium Interior Upgrade Package (P4)	017HE	—	—	●	○	Electric rear sunblind (not available on Jaguar XF Sportbrake), Manual rear side window blinds, Four-zone Climate Control (inc B-pillar vents and ducts in glove box), ambient lighting upgrade including 10 color variable illumination
Driver Assistance Package‡ (P5)	017DS	—	—	○	○	Adaptive Cruise Control (ACC) with Forward Alert, Advanced Emergency Brake Assist with Queue Assist and Intelligent Emergency Braking, 360° Parking Aid, Traffic Sign Recognition and Intelligent Speed Limiter, Blind Spot Assist, Park Assist - Parallel, Perpendicular & Parallel Exit
Tech Package* (P6)	074PW	—	○	●	○	12.3" Interactive Driver Display, CD/DVD Player, Meridian 825W Surround Sound System
Black Package (P7)	032EI	—	—	—	○	Radiator grille - Gloss Black insert with Gloss Black surround, Gloss Black side power vents, Gloss Black trunk finisher
Connect Pro Package (P8)	011CB	○	—	—	—	InControl Apps, Pro Services and Wi-Fi Hotspot

STAND ALONE OPTIONS

Heated front windshield	040AK	○	○	○	○	—
Head-up Display‡	039IB	—	○	●	○	
4G Wi-Fi Hotspot** with 3GB or 3 month complimentary data plan (which ever comes first)	025RC	P8	●	●	●	Refer to page 46
Adaptive Dynamics with Configurable Dynamics‡	027CW	—	○	○	●	Refer to page 32
Powertrain '20d' '25t' or '30t' debadging	057EV	NCO	NCO	NCO	—	—
Rear Camera‡	086FA	●	●	●	●	—
Keyless Entry	066AC	○	●	●	●	—
Cargo space Partition Net (only available on Jaguar XF Sportbrake)	026EU	—	○	—	○	
Cargo space Storage Rails (only available on Jaguar XF Sportbrake)	135AH	—	○	—	○	
Cabin Air Ionization (only available on Jaguar XF Sportbrake)	022GB	—	○	—	○	
Activity Key (only available on Jaguar XF Sportbrake)	066CA	—	○	—	○	Refer to page 19

3 CHOOSE YOUR COLOR

 [Configure your vehicle at jaguarusa.com](https://www.jaguarusa.com)

SOLID

Fuji White

Narvik Black

METALLIC

Yulong White

Santorini Black

Indus Silver

Corris Grey

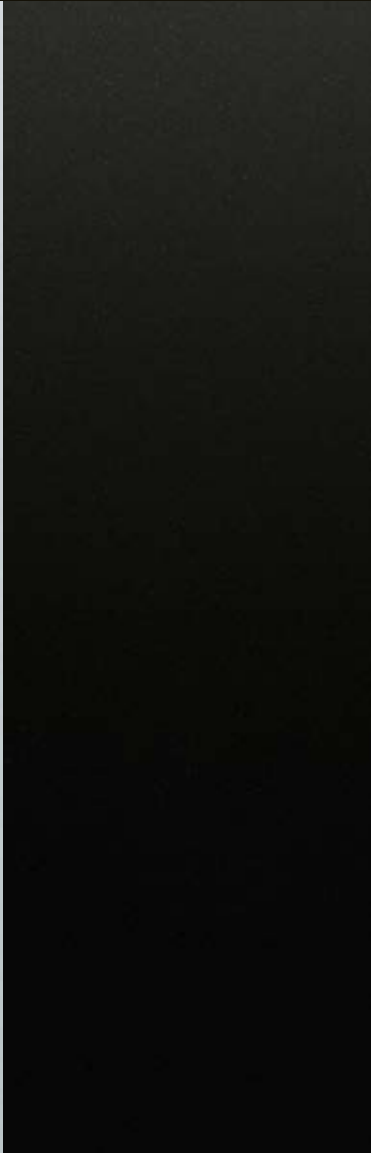
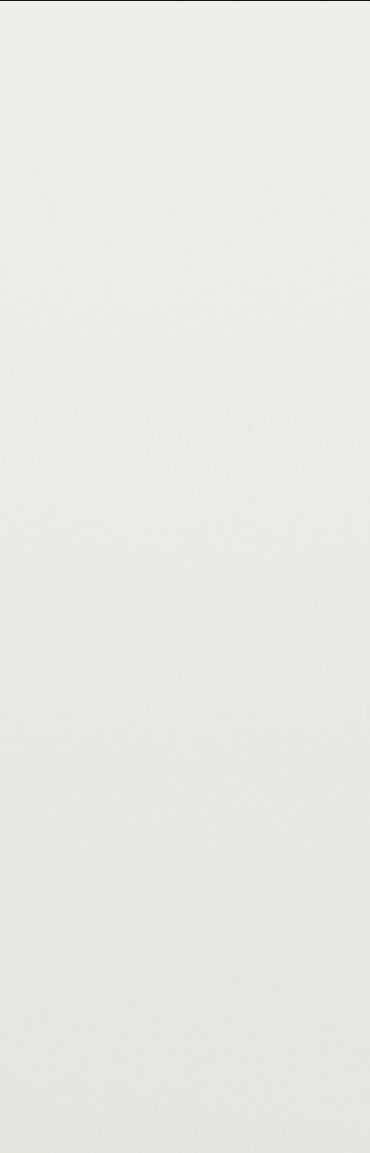

PREMIUM PALETTE

Loire Blue

Caesium Blue

Firenze Red

Rossello Red

Carpathian Grey

Silicon Silver



4 CHOOSE YOUR WHEELS

 Configure your vehicle at jaguarusa.com



18" 5 SPOKE
'STYLE 5034'



18" 5 SPOKE
'STYLE 5033'

ALLOY WHEEL FINISH	18" 5 SPOKE 'STYLE 5034'	18" 5 SPOKE 'STYLE 5033'
ALLOY WHEEL/SIZE	Silver 8.0 J x 18"	Silver 8.0J x 18"
TIRE SIZE	245/45 R18	245/45 R18
CODE	029WK	029WM
Premium	—	● (20d & 25t)
Prestige	—	—
Portfolio	—	—
S	—	—



18" 7 SPLIT-SPOKE
'STYLE 7011'



19" 5 SPOKE
'STYLE 5035'



19" 7 SPLIT-SPOKE
'STYLE 7012'

ALLOY WHEEL FINISH	18" 7 SPLIT-SPOKE 'STYLE 7011'	19" 5 SPOKE 'STYLE 5035'	19" 7 SPLIT-SPOKE 'STYLE 7012'
ALLOY WHEEL/SIZE	Silver 8.0J x 18"	Gloss Dark Grey/Diamond Turned 8.0J x 19"	Silver 8.0J x 19"
TIRE SIZE	245/45 R18	245/40 R19	245/40 R19
CODE	029WL	029WR	029WN
Premium	● (30t only)	—	—
Prestige	—	—	● (30t only)
Portfolio	—	—	● (30t only)
S	—	—	—

● Standard ○ Option — Not Applicable



19" 7 SPLIT-SPOKE
'STYLE 7013'



19" 7 SPLIT-SPOKE
'STYLE 7013'



20" 9 SPLIT-SPOKE
'STYLE 9004'

ALLOY WHEEL FINISH	Silver	Contrast/Diamond Turned	Silver
ALLOY WHEEL/SIZE	8.0J x 19"	8.0J x 19"	8.5J x 20"
TIRE SIZE	245/40 R19	245/40 R19	255/35 R20
CODE	029WO	029WS	029WB

Premium	○	—	—
Prestige	● (20d & 25t)	○	○
Portfolio	—	○	○
S	—	—	—



20" 5 SPLIT-SPOKE
'STYLE 5031'



20" 5 SPLIT-SPOKE
'STYLE 5031'



20" 5 SPLIT-SPOKE
'STYLE 5036'

ALLOY WHEEL FINISH	Gloss Dark Grey/Diamond Turned	Gloss Black	Gloss Dark Grey/Diamond Turned
ALLOY WHEEL/SIZE	8.5J x 20"	8.5J x 20"	8.5J x 20"
TIRE SIZE	255/35 R20	255/35 R20	255/35 R20
CODE	029VZ	029WE	029WA

Premium	—	—	—
Prestige	—	—	—
Portfolio	—	—	—
S	●	○	○

5 CHOOSE YOUR INTERIOR

 Configure your vehicle at jaguarusa.com

PREMIUM						
	SEAT WITH TONAL STITCH	VENEER	UPPER FASCIA WITH TONAL STITCH	HEADLINING SUEDECLOTH ¹	CARPET	INTERIOR TRIM CODES
Luxtec seats	Ebony with Ebony	Gloss Black	Ebony with Ebony	Light Oyster	Ebony	SFY
	Latte with Latte	Gloss Black	Espresso with Espresso	Light Oyster	Espresso	TRA
	Light Oyster with Light Oyster	Gloss Black	Oyster with Oyster	Light Oyster	Oyster	TRB
PRESTIGE						
	SEAT WITH TONAL STITCH	VENEER ²	UPPER FASCIA WITH TONAL STITCH	HEADLINING SUEDECLOTH ¹	CARPET	INTERIOR TRIM CODES
Grained leather seats	Ebony with Ebony	Gloss Black	Ebony with Ebony	Light Oyster	Ebony	SFW
	Latte with Latte	Gloss Black	Espresso with Espresso	Light Oyster	Espresso	TRD
	Light Oyster with Light Oyster	Gloss Black	Oyster with Oyster	Light Oyster	Oyster	TRE

¹Morzine headlining available as an option.

²Optional veneers are available.

PORTFOLIO						
	SEAT WITH INSERT AND CONTRAST STITCH	VENEER ²	UPPER FASCIA WITH CONTRAST STITCH	HEADLINING SUEDECLOTH ¹	CARPET	INTERIOR TRIM CODES
Windsor leather seats	Ebony with Ebony	Ebony with Ebony	Grey Figured Ebony	Light Oyster	Ebony	SGB
	Latte with Latte	Espresso with Espresso	Grey Figured Ebony	Light Oyster	Espresso	TRO
	Light Oyster with Light Oyster	Oyster with Oyster	Grey Figured Ebony	Light Oyster	Oyster	TRP
	Espresso with Espresso	Espresso with Espresso	Grey Figured Ebony	Light Oyster	Espresso	TRR
	Sienna Tan with Sienna Tan	Ebony with Ebony	Grey Figured Ebony	Light Oyster	Ebony	SGA
S						
	SEAT WITH INSERT AND CONTRAST STITCH	VENEER ²	UPPER FASCIA WITH CONTRAST STITCH	HEADLINING SUEDECLOTH ¹	CARPET	INTERIOR TRIM CODES
Grained leather 'S' embossed sports seats	Ebony/Ebony with Light Oyster	Grey Figured Ebony	Ebony with Light Oyster	Ebony	Ebony	SGD
	Pimento Red/Ebony with Ebony	Grey Figured Ebony	Ebony with Pimento Red	Ebony	Ebony	SFZ
	Light Oyster/Ebony with Ebony	Grey Figured Ebony	Ebony with Light Oyster	Ebony	Ebony	SGH
	Brogue/Brogue with Light Oyster	Grey Figured Ebony	Ebony with Light Oyster	Ebony	Ebony	SFU

5 CHOOSE YOUR INTERIOR

⚙️ Configure your vehicle at jaguarusa.com

Interior shown: Ebony Luxtec seats with Ebony fascia, Morse Code Aluminum finisher, Gloss Black veneer and Light Oyster headlining.



XF PREMIUM

INTERIOR COLOR COMBINATIONS

1

SEAT WITH TONAL STITCH

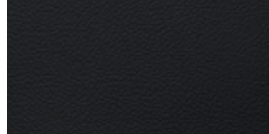

Ebony with Ebony

2

VENEER



Gloss Black

3

HEADLINING SUEDECLOTH*



Light Oyster

4

UPPER FASCIA WITH TONAL STITCH



Ebony with Ebony

5

FINISHER



Morse Code Aluminum

6

CARPETS



Ebony

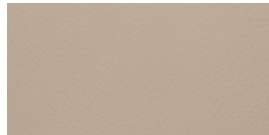

Latte with Latte



Gloss Black

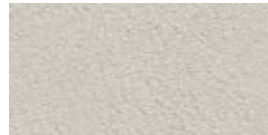

Light Oyster



Espresso with Espresso

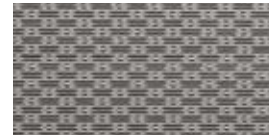

Morse Code Aluminum



Espresso

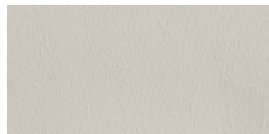

Light Oyster with Light Oyster



Gloss Black

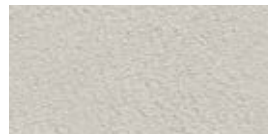

Light Oyster



Oyster with Oyster



Morse Code Aluminum



Oyster

*Morzine headlining available as an option.

5 CHOOSE YOUR INTERIOR











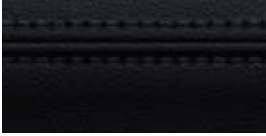

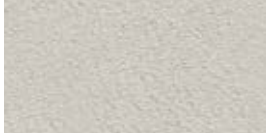
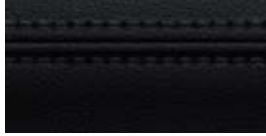

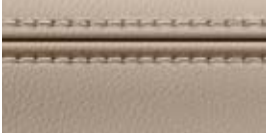
⚙️ Configure your vehicle at jaguarusa.com

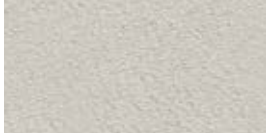
Interior shown: Ebony grained leather seats with Ebony tonal stitch, Ebony fascia, Morse Code Aluminum finisher, Gloss Black veneer and Light Oyster headlining.



PRESTIGE

INTERIOR COLOR COMBINATIONS

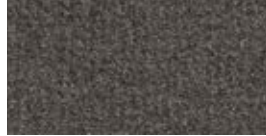
1	2	3	4	5	6
SEAT WITH TONAL STITCH	VENEER	HEADLINING SUEDECLOTH*	UPPER FASCIA WITH TONAL STITCH	FINISHER	CARPETS
					
Ebony with Ebony	Gloss Black	Light Oyster	Ebony with Ebony	Morse Code Aluminum	Ebony
					
Latte with Latte	Gloss Black	Light Oyster	Espresso with Espresso	Morse Code Aluminum	Espresso
					
Light Oyster with Light Oyster	Gloss Black	Light Oyster	Oyster with Oyster	Morse Code Aluminum	Oyster

VENEER OPTIONS

Gloss Burl Walnut Veneer

*Morzine headlining available as an option.

5 CHOOSE YOUR INTERIOR

Configure your vehicle at jaguarusa.com











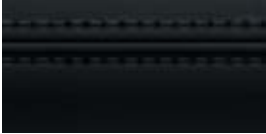

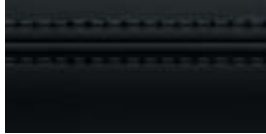















Interior shown: Sienna Tan Windsor leather with Sienna Tan tonal stitch, Ebony fascia, Morse Code Aluminum finisher, Gloss Figured Ebony veneer and Ebony suedecloth headliner.

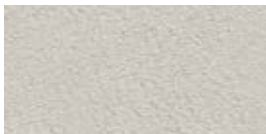

PORTFOLIO

INTERIOR COLOR

STANDARD

1	2	3	4	5	6
SEAT WITH TONAL STITCH	VENEER	HEADLINING SUEDECLOTH*	UPPER FASCIA WITH TONAL STITCH	FINISHER	CARPETS
					
Ebony with Ebony	Gloss Figured Ebony	Light Oyster	Ebony with Ebony	Morse Code Aluminum	Ebony
					
Latte with Latte	Gloss Figured Ebony	Light Oyster	Espresso with Espresso	Morse Code Aluminum	Espresso
					
Light Oyster with Light Oyster	Gloss Figured Ebony	Light Oyster	Oyster with Oyster	Morse Code Aluminum	Oyster
					
Espresso with Espresso	Gloss Figured Ebony	Light Oyster	Espresso with Espresso	Morse Code Aluminum	Espresso
					
Sienna Tan with Sienna Tan	Gloss Figured Ebony	Light Oyster	Ebony with Ebony	Morse Code Aluminum	Ebony

VENEER OPTIONS

Gloss Burl Walnut veneer or Satin Burl Ash Veneer

*Morzine headlining available as an option.

5 CHOOSE YOUR INTERIOR

Configure your vehicle at jaguarusa.com

Interior shown: Light Oyster and Ebony perforated grained leather sports seats with Ebony contrast stitch, Ebony fascia with Light Oyster contrast stitch, Dark Hex Aluminum finisher, Satin Grey Figured Ebony veneer and Ebony headlining.



S

INTERIOR COLOR COMBINATIONS

1

SEAT WITH INSERT
AND CONTRAST STITCH

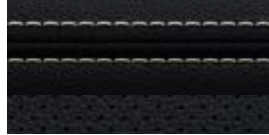

Ebony/Ebony with Light Oyster

2

VENEER



Satin Grey Figured Ebony

3

HEADLINING SUEDECLOTH*



Ebony

4

UPPER FASCIA
WITH CONTRAST STITCH

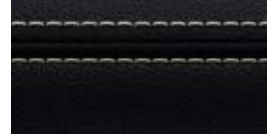

Ebony with Light Oyster

5

FINISHER



Dark Hex Aluminum

6

CARPETS



Ebony



Pimento Red/Ebony with Ebony



Satin Grey Figured Ebony



Ebony



Ebony with Pimento Red



Dark Hex Aluminum



Ebony



Light Oyster/Ebony with Ebony



Satin Grey Figured Ebony



Ebony

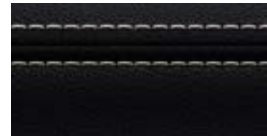

Ebony with Light Oyster



Dark Hex Aluminum



Ebony



Brogue/Brogue
with Light Oyster



Satin Grey Figured Ebony



Ebony

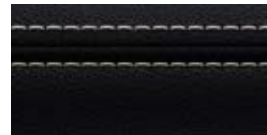

Ebony with Light Oyster



Dark Hex Aluminum



Ebony

VENEER OPTIONS

Gloss Figured Ebony Veneer, Carbon Fiber Veneer or Satin Fine Line Veneer

*Morzine headlining available as an option.

5 CHOOSE YOUR INTERIOR

 Configure your vehicle at jaguarusa.com

Gloss Black Veneer

Carbon Fiber Veneer

Satin Burl Ash Veneer

Gloss Figured Ebony Veneer



Satin Grey Figured Ebony Veneer



Satin Fine Line Veneer



Gloss Burl Walnut Veneer



6 CHOOSE YOUR JAGUAR GEAR - ACCESSORIES

The genuine range of accessories from Jaguar for your XF sedan.

 Configure your vehicle at jaguarusa.com



Watersports Carrier* **C2Z21730**

A versatile system for transporting a variety of water sports equipment including surfboard, kayak or sailboard. Tilts to facilitate loading/unloading.

*Requires roof cross bars T2H14468.

VEHICLE SHOWN: JAGUAR XF SEDAN S IN YULONG WHITE WITH OPTIONAL EQUIPMENT



Aluminum Paddle Shifters
T2R6547MMU (Brushed Aluminum - shown)
T2R6547CAY (Red)

Replacement steering wheel gearshift paddles offered in a premium aluminum material providing a high quality finish to a key contact point in the vehicle. Manufactured from billet machined aluminum, the paddles are hand brushed for a premium finish and anodized to ensure they will not deteriorate with wear.



Premium Carpet Mat Set
T2H7171PVJ (Jet - shown)
T2H7171AMT (Oyster)
T2H7171AAM (Espresso)
T2H7173PVJ (Jet, AWD only)
T2H7173AMT (Oyster, AWD only)
T2H7173AAM (Espresso, AWD only)

Luxurious, tailored 60.46 oz/yd² carpet mats set with Jaguar Ingot and Nubuck edge binding.



Central Armrest Chiller/Warmer
T2H7739

Food and drinks chiller and warmer that acts as a rear center armrest. With a leather-covered top, it is held in place by the center seat belt and powered from the rear auxiliary socket. Ideal for long trips with the family.



Click and Play - iPad Mini
J9C2165

The Click and Play iPad Mini holder is part of the Click and Go range. This removable tablet holder attachment can easily be positioned at multiple angles for in-cabin comfort and rear entertainment.



Personalized Illuminated Sill Treadplates
T2H17122PVJ (Jet)

Elegantly styled stainless steel sill treadplate finishers for driver or passenger doors. Illuminates when either the driver or passenger doors are opened. Highlighted by soft Phosphor Blue lighting. Allows customer to specify a monochrome 'motif' in a choice of approved typefaces/scripts.



Rubber Mats
T4H7742 - LHD
T2H7743 - LHD AWD

Hard wearing Jaguar branded rubber mats provide added protection for your vehicle's carpets.

6 CHOOSE YOUR JAGUAR GEAR - ACCESSORIES

 Configure your vehicle at jaguarusa.com



Gloss Black Side Vent
T2H19534 - Left Side
T2H19531 - Right Side

Jaguar branded, Gloss Black side power vents provide a dynamic exterior styling enhancement.



Carbon Fiber Side Vent
T2H18318 - Left Side
T2H18319 - Right Side

High grade Carbon Fiber side power vents provide a performance-inspired styling upgrade.



Splash Guards
T2H12952 - Front
T2H12953 - Front (R-Sport & S)
T2H12954 - Rear

Jaguar branded splash guards complement the lines of your vehicle, reduce spray and provide protection from dirt and stone chippings.



Gloss Black Mirror Cap
C2D6067PEC - Left Side
C2D6066PEC - Right Side

Gloss Black mirror covers accentuate the dynamic design of the exterior mirrors.



Carbon Fiber Mirror Cap
C2P24177 - Left Side
C2P24176 - Right Side

High grade Carbon Fiber mirror covers provide a performance-inspired styling upgrade.



Rear Tailgate Trim - Gloss Black¹
T2H17748

Add style and visual distinction with Gloss Black finish rear tailgate trim.

¹Requires roof cross bars T2H14468. ²Only available on Jaguar XF Sedan.



Roof Cross Bars²
T2H14468

Jaguar branded cross bars required for fitting all roof carrying equipment. Engineered specifically for your vehicle.



Roof Luggage Box¹
C2C41628

Spacious 14.4 cubic feet capacity lockable roof luggage box, measuring 68 x 32 x 17 inches.



Roof Sport Box¹
C2C41627

Spacious 11.3 cu.ft. capacity lockable roof box designed for sports equipment, measuring 81.1 x 33 x 13.3 inches.



Ski/Snowboard Holder¹
C2A1538

A safe and secure Jaguar branded system for transporting winter sports equipment. Incorporates slider rails for easy loading. For four pairs of skis or two snowboards.



Roof Mounted Cycle Carrier¹
C2A1540

An easy to fit, roof mounted, lockable cycle carrier which carries one bike per holder. A maximum of three holders can be fitted.



All-Weather Car Cover²
T2H7756

All-weather tailored cover for the Jaguar XF with the Jaguar logo. Protect your Jaguar XF from the elements, including showers, frost and dust. Quick and easy to fit.

6 CHOOSE YOUR JAGUAR GEAR - ACCESSORIES

The genuine range of accessories from Jaguar for the XF Sportbrake.

 Configure your vehicle at jaguarusa.com



Roof Mounted Cycle Carrier¹ C2A1539

An easy to fit, roof mounted, lockable cycle carrier which carries one bike per holder. A maximum of three holders can be fitted.

¹Requires roof cross bars T2H24300. ²Only available on Jaguar XF Sportbrake.

VEHICLE SHOWN: JAGUAR XF SPORTBRAKE S IN YULONG WHITE WITH OPTIONAL EQUIPMENT



Roof Cross Bar²
T2H24300

Jaguar branded cross bars required for fitting all roof carrying equipment. Engineered specifically for your vehicle.



Roof Sport Box¹
C2C41627

Spacious 11.3 cu.ft. capacity lockable roof box designed for sports equipment, measuring 81.1 x 33 x 13.3 inches.



Fork Mounted Cycle Carrier¹
C2A1540

Fitted to the roof, the fork mounted cycle carrier provides a simple and secure fitting with the bike front wheel removed, ideally suited to lightweight bikes and 'racing' wheels. A separate carrier is included for the front wheel. Easy to fit, lockable cycle carrier which carries one bike per holder. A maximum of three holders can be fitted.



Watersports Carrier¹
C2Z21730

A versatile system for transporting a variety of water sports equipment including surfboard, kayak or sailboard. Tilts to facilitate loading/unloading.



Ski/Snowboard Holder¹
C2A1538

A safe and secure Jaguar branded system for transporting winter sports equipment. Incorporates slider rails for easy loading. For four pairs of skis or two snowboards.



Central Armrest Cooler
T2H7739

Food and drinks chiller and warmer that acts as a rear center armrest. With a leather-covered top, it is held in place by the center seat belt and powered from the rear auxiliary socket. Ideal for long journeys with the family.

6 CHOOSE YOUR JAGUAR GEAR - ACCESSORIES

 Configure your vehicle at jaguarusa.com



Click and Play - iPad® 2-4¹
J9C2163

Click and Play is a removable tablet holder attachment which is available for various tablets, and can be easily positioned in multiple angles for in cabin comfort and rear entertainment.



Click and Hook¹
J9C2169

Click and Hook is a universal hook that creates extra storage space for items to be hung.



Click and Hang¹
J9C2167

Click and Hang is a removable coat hanger allowing for shirts and jackets to be kept crease-free while transporting.



Union Jack Sill Treadplates
T2H17123PVJ - Ebony
T2H17123AMT - Oyster

Elegantly styled stainless steel sill treadplate finisher for driver or passenger doors featuring a distinctly British design.



Sport Pedal Covers
T2H3746 - Automatic

Made from stainless steel and rubber, the pedal kit fits securely over existing pedals for a contemporary, sporting appearance.



Luggage Compartment Waterproof Liner²
T2H24704

Total protection for the luggage compartment and second row seat back. Bespoke developed for Jaguar XF Sportbrake, the liner is a fully waterproof and is easy to fit or remove in a matter of minutes.

¹Requires Click and Go base unit to be fitted (J9C2168) ²Only available on XF Sportbrake. ³Pet package can be fitted with either Rubber Liner (T2H25062) or Rubber Mat (T2H24552).



Aperture Retention Net²
T2H31242

The aperture retention net prevents small items from falling out of the cargo space when the tailgate is opened and maximizes packing space. Manufactured from premium lightweight materials including high grade machined aluminum to ensure robust quality.



**Pet Package with Luggage
Compartment Partition**
T2H31273

**Luggage Compartment
Rubber Liner³**
T2H25062

Combines the cargo space rubber mat with the full height partition, to protect both your vehicle and your pet. The rubber mat is waterproof, protecting the vehicle's cargo space floor carpet. The full height partition prevents access to the passenger compartment, while containing and protecting your pet.



Luggage Compartment Collapsible Organizer
T2H7752

Collapsible luggage compartment organizer keeps items from shifting during transport with two durable straps.



Luggage Compartment Rubber Mat²
T2H24552

This premium mat is tailored specifically to protect the luggage compartment. Light and durable, it is easily removable for cleaning.



Luggage Compartment Multi-purpose Liner²
T2H24651

All-in-one premium cargo space carpet mat and double layer reversible rubber liner helps protect the rear cargo space area from general dirt. The liner can be folded out to cover the back of the second row seats when folded down. Also includes fold out bumper protector.



Bumper Protector²
T2H24701

Provides protection for the rear bumper from scuffs and scratches and helps to prevent clothing from collecting dirt when loading and unloading.

TECHNICAL DETAILS

 Configure your vehicle at jaguarusa.com

ENGINES		20d 2.0 LITER 4-CYLINDER TURBOCHARGED DIESEL	25t 2.0 LITER 4-CYLINDER TURBOCHARGED GAS	30t 2.0 LITER 4-CYLINDER TURBOCHARGED GAS	20d 2.0 LITER 4-CYLINDER TURBOCHARGED DIESEL
Drive		RWD	RWD	RWD	AWD
Capacity	cc	1,999	1,997	1,997	1,999
Maximum power	hp	177	247	296	177
@rev/min	rpm	4,000	5,500	5,500	4,000
Maximum torque	lb-ft	318	269	295	318
@rev/min	rpm	1,750 – 2,500	1,300 – 4,500	1,500 – 4,500	1,750 – 2,500
Transmission		8-speed Automatic	8-speed Automatic	8-speed Automatic	8-speed Automatic

PERFORMANCE*		XF Sedan	XF Sedan	XF Sedan	XF Sedan
0-60 mph	seconds	7.9	6.4	5.7	8.0
Top speed	mph	142	152	155	138

DIMENSIONS		XF Sedan	XF Sedan	XF Sedan	XF Sedan
Overall length	in	195.0	195.0	195.0	195.0
Overall width (inc. mirrors)	in	82.3	82.3	82.3	82.3
Overall width (exc. mirrors)	in	78.2	78.2	78.2	78.2
Overall height	in	57.4	57.4	57.4	57.4
Wheelbase	in	116.5	116.5	116.5	116.5
Ground clearance	in	4.57	4.57	4.57	4.57
Turning circle diameter (curb-to-curb)	ft	38.1	38.1	38.1	38.1
Trunk volume	cu-ft	19.1	19.1	19.1	19.1
Tank capacity	US gallons	17.4	19.5	19.5	17.4

WEIGHT ¹		XF Sedan	XF Sedan	XF Sedan	XF Sedan
Curb weight from	lbs	3,655	3,590	3,665	3,735
Gross vehicle weight	lbs	5,055	4,980	4,980	5,155

ENGINE AVAILABILITY		XF Sedan	XF Sedan	XF Sedan	XF Sedan
Premium		●	●	●	●
Prestige		●	●	●	●
Portfolio		—	—	●	—
S		—	—	—	—

● Available — Not Available

*Always follow local speed limits.

¹Weights reflect vehicles to standard specifications. Optional extras increase weight.

ENGINES		25t 2.0 LITER 4-CYLINDER TURBOCHARGED GAS	30t 2.0 LITER 4-CYLINDER TURBOCHARGED GAS	S 3.0 LITER V6 380 SUPERCHARGED GAS
Drive		AWD	AWD	AWD
Capacity	cc	1,997	1,997	2,995
Maximum power	hp	247	296	380
@rev/min	rpm	5,500	5,500	6,500
Maximum torque	lb-ft	269	295	332
@rev/min	rpm	1,300 - 4,500	1,500 - 4,500	4,500
Transmission		8-speed Automatic	8-speed Automatic	8-speed Automatic

PERFORMANCE*		XF Sedan	XF Sedan	XF Sportbrake	XF Sedan	XF Sportbrake
0-60 mph	seconds	6.3	5.6	5.7	5.0	5.3
Top speed	mph	147	155	155	155	121

DIMENSIONS		XF Sedan	XF Sedan	XF Sportbrake	XF Sedan	XF Sportbrake
Overall length	in	195.0	195.0	195.1	195.0	195.1
Overall width (inc. mirrors)	in	82.3	82.3	82.3	82.3	82.3
Overall width (exc. mirrors)	in	78.2	78.2	78.2	78.2	78.2
Overall height	in	57.4	57.4	58.9	57.4	58.9
Wheelbase	in	116.5	116.5	116.5	116.5	116.5
Ground clearance	in	4.57	4.57	4.57	4.57	4.57
Turning circle diameter (curb-to-curb)	ft	38.1	38.1	38.1	38.1	38.1
Trunk volume	cu-ft	19.1	19.1	31.7	19.1	31.7
Tank capacity	US gallons	19.5	19.5	19.5	19.5	19.5

WEIGHT ¹		XF Sedan	XF Sedan	XF Sportbrake	XF Sedan	XF Sportbrake
Curb weight from	lbs	3,695	3,770	3,885	3,870	4,035
Gross vehicle weight	lbs	5,090	5,135	5,290	5,220	5,355

ENGINE AVAILABILITY		XF Sedan	XF Sedan	XF Sportbrake	XF Sedan	XF Sportbrake
Premium		●	●	—	—	—
Prestige		●	●	●	—	—
Portfolio		—	●	—	—	—
S		—	—	—	●	●

JAGUAR XF SEDAN DIMENSIONS

 Configure your vehicle at jaguarusa.com

JLR Product to confirm missing numbers



116.5 inches
195.0 inches



Vehicle Height

With roof antenna 57 inches

Headroom

Maximum front headroom with Fixed Metal roof fitted 37 inches
Rear headroom 56 inches

Legroom

Maximum front legroom 41 inches
Maximum rear legroom 3.4 inches

Cargo space Capacity

Rear seats upright

Height 37 inches, Width 38 inches
Cargo space volume 19 cu.ft.
Cargo space width between arches 39 inches
Length at floor 27 inches

Rear seats forward

Height 37 inches, Width 38 inches
Cargo space volume 31 cu.ft.
Cargo space width between arches 39 inches
Length at floor 41 inches

Turning Circle

Curb-to-curb 38 ft.
Wall-to-wall 39.2 ft.
Turns lock-to-lock 2.5



82.3 inches
63.2 inches (62.9 inches 20" Wheels)
78.2 inches



4.6 inches
57.4 inches
62.8 inches (62.4 inches 20" Wheels)

JAGUAR XF SPORTBRAKE DIMENSIONS



Vehicle Height

With roof antenna 59 inches

Headroom

Maximum front headroom with
Fixed panoramic roof fitted 38 inches
Rear headroom 39 inches

Legroom

Maximum front legroom 41 inches
Maximum rear legroom 38 inches

Cargo space Capacity

Rear seats upright

Height 25 inches, Width 41 inches
Cargo space volume 19 cu.ft.
Cargo space width between
arches 41 inches
Length at floor 43 inches

Rear seats forward

Height 25 inches, Width 41 inches
Cargo space volume 60 cu.ft.
Cargo space width between
arches 41 inches
Length at floor 77 inches

Turning Circle

Curb-to-curb 38 ft.
Wall-to-wall 39.2 ft.
Turns lock-to-lock 2.5



SPECIAL VEHICLE OPERATIONS



Special Vehicle Operations (SVO) designs and engineers products that amplify Jaguar and Land Rover core brand values; focusing on luxury, performance and capability.

Our team of specialists is completely focused on enhancing and personalizing our relationship with our most discerning and enthusiastic customers – delivering experiences that our customers will love for life.

SVO is responsible for the creation of a suite of halo products that showcase the pinnacle of Jaguar design and engineering capabilities, enabling our customers to indulge their passion for spectacular new vehicles.

THE NEW SVO TECHNICAL CENTER

In the heart of the British Midlands is SVO's brand new Technical Center. This state-of-the-art facility represents a \$25 million dollar investment by Jaguar Land Rover, and features four zones designed to support the creation of truly breath-taking vehicles. In addition to the Commissioning and Presentation suites, our manufacturing center is responsible for the assembly and hand-finishing of SVO halo and Collector's Edition vehicles, and a world-class paint facility ensures an exquisite finish for every vehicle we create.

BESPOKE BY SVO

Bespoke by SVO was born out of an innate understanding of what our most discerning clients value more than anything else – to own something completely unique to them. Something only they can have, reflecting who they are and what they hold most dear. With that in mind, SVO developed innovative Commissioning and Presentation suites enabling creation of the most refined and luxurious vehicles in the world. This special new facility is housed within the new SVO Technical Center in Warwickshire, England.





THE WORLD OF JAGUAR

Choose the Jaguar XF and you're joining the exciting World of Jaguar.

BEHIND THE SCENES

Our factory tours give you the unique opportunity to experience the whole process of how our vehicles are brought to life - from the molding of sheet metal to those intricate final touches. At our state-of-the-art production facilities, you'll get to see how skilled technicians and sophisticated machines work seamlessly together to perfect some of Jaguar's most breathtaking cars.

Find out more at jaguarusa.com

ICE DRIVE EXPERIENCES

Take your driving to the next level with the Jaguar Land Rover Ice Drive Experience. We currently offer an adventure in Arjeplog, Sweden, that will test and develop your performance driving skills in extreme conditions. It's a rare chance for owners and enthusiasts to tackle some of the harshest and most challenging tracks on earth, under the skilled guidance of our experts. Our driving instructors are of the highest-caliber and will be with you every step of the way - ready to impart years of driving wisdom. You will dance on ice, glide around some of the most awe-inspiring corners imaginable and realize the true exhilarating potential of Jaguar and Land Rover.

If you'd like to be part of the next adventure, find out more by visiting jaguarusa.com





FORMULA E

Jaguar's reputation for performance, technology and design was forged by the world's most challenging circuits and championships. From Le Mans to Formula 1, and now Formula E, the grid is our test-bed. Formula E provides the perfect proving ground for electric vehicle technology in a high performance environment. The racing series accelerates the development of Jaguar's electric powertrains. With every race, Formula E helps Jaguar engineers create better electric vehicles.

JAGUAR COLLECTION

The latest from the Jaguar Collection has been crafted with the same design execution and attention to detail that goes into all of our vehicles. This is evident in our clothing range, premium leather items and luxury travel goods. To celebrate Jaguar's heritage, we also have a collection that honors past achievements and features race inspired gift items and apparel.

Visit shop.jaguarusa.com to browse the Jaguar collection.

THE JAGUAR MAGAZINE

This is our own vibrant, cosmopolitan and contemporary magazine. Produced by a team of enthusiastic designers and feature writers, it goes behind the scenes at Jaguar as well as providing insight into the world of luxury, design, style and travel.





AT YOUR SERVICE

As well as providing a range of exclusive services and lifestyle products, the World of Jaguar makes owning and driving carefree and easy.

JAGUAR ELITECARE*

Enjoy your Jaguar with peace of mind. The Jaguar XF is backed by Jaguar EliteCare, our coverage program including New Vehicle Limited Warranty, Complimentary Scheduled Maintenance, Roadside Assistance and Jaguar InControl Remote & Protect™.

GENUINE PARTS

Jaguar vehicles Genuine Parts are designed, tested and manufactured to our uncompromising standards for quality, fit and durability. Each part is engineered specifically for your Jaguar XF to contribute to optimum performance and to help maximize its lifespan.

FLEET & BUSINESS

Jaguar vehicles are dynamic and distinctive and that help companies express the unique character and personality of their business. We are committed to providing customer focused aftersales services, ensuring that every Jaguar performs to the highest standard and in the most cost-efficient way for businesses. Visit jaguarusa.com/fleet-and-business for more information.

JAGUAR ASSISTANCE

Jaguar Assistance provides assistance in motoring emergencies, from immobilization due to mechanical breakdown to minor problems such as punctures. You can rely on our roadside assistance, whatever the situation, anywhere in North America during the vehicles warranty period.

JAGUAR FINANCIAL SERVICES

New or used, for personal or business use, we have a finance option that puts you in complete control. Please speak to your local Jaguar Retailer to find out more.

IMPORTANT NOTICE

Jaguar Land Rover Limited is constantly seeking ways to improve the specification, design and production of its vehicles, parts and accessories and alterations take place continually. Whilst every effort is made to produce up to date literature, this brochure should not be regarded as an infallible guide to current specifications or availability, nor does it constitute an offer for the sale of any particular vehicle, part or accessory. Distributors and retailers are not agents of Jaguar Land Rover Limited by any express or implied undertaking or representation.

COLORS

The colors reproduced here are subject to the limitations of the printing process and may therefore vary slightly from the actual vehicle. The company reserves the right to alter or withdraw any color finish without notice. Some of these colors may not be obtainable in your country. Please check availability of colors and current specifications with your Jaguar Retailer. Distributors and retailers are not agents of Jaguar Land Rover Limited and have absolutely no authority to bind Jaguar Land Rover Limited to any express or implied undertaking or representation.

ENVIRONMENTAL INNOVATION AT JAGUAR

Jaguar is committed to reducing dependency on fossil fuels, using fewer natural resources and creating less waste as part of our approach to responsible and sustainable business development.

Search 'Jaguar Environmental Innovation' for more details.

*For complete details regarding Jaguar EliteCare coverage please visit JAGUARUSA.COM, call 1.800.4.JAGUAR or visit your local Jaguar Retailer.

Castrol EDGE Professional recommended by Jaguar.

Meridian is the trademark of Meridian Audio Ltd.

The Bluetooth® word mark and logos are owned by the Bluetooth SIG, Inc. and any use of such marks by Jaguar Land Rover Limited is under license. iPhone is a trademark of Apple Inc., registered in the US and other countries. The navigation system must always be used in conditions that will not affect the driver's ability to drive safely or affect the safety of other road users.

VEHICLES SHOWN FRONT COVER: JAGUAR XF SPORTBRAKE S IN YULONG WHITE AND JAGUAR XF SEDAN S IN CORRIS GREY WITH OPTIONAL EQUIPMENT

VEHICLES SHOWN BACK COVER: JAGUAR XF SPORTBRAKE S IN YULONG WHITE AND JAGUAR XF SEDAN S IN CORRIS GREY WITH OPTIONAL EQUIPMENT

Jaguar Land Rover North America LLC
100 Jaguar Land Rover Way
Mahwah, NJ 07495-1100

jaguarusa.com

© 2018 Jaguar Land Rover North America, LLC

1X2601910MCOBUSEN01P

