

JAGUAR XF SALOON AND XF SPORTBRAKE



THE ART OF PERFORMANCE





BY APPOINTMENT TO
HM THE QUEEN
MANUFACTURERS OF
MOTOR VEHICLES
JAGUAR LAND ROVER LIMITED
COVENTRY



BY APPOINTMENT TO
HRH THE DUKE OF EDINBURGH
MANUFACTURERS OF
MOTOR VEHICLES
JAGUAR LAND ROVER LIMITED
COVENTRY



BY APPOINTMENT TO
HRH THE PRINCE OF WALES
MANUFACTURERS OF
MOTOR VEHICLES
JAGUAR LAND ROVER LIMITED
COVENTRY



JAGUAR

THE ART OF PERFORMANCE

Every day we push performance to its limit. Our performance. Our cars' performance.
We innovate, we engineer, we design. We master rules and then break them.
Only to push further. Past the limits of convention. This is when performance becomes art.

Jaguar. The Art of Performance.





CONTENTS

INTRODUCTION

The Concept of XF	07
XF - The Facts	08

DESIGN

Exterior Principles	10
Exterior Aerodynamics	12
Interior	15
Interior Space	17
Space and Versatility	19

PERFORMANCE

Engines Overview	22
Advanced Aerodynamics	26
Lightweight Aluminium Architecture	29
Chassis and Suspension	30

DRIVING TECHNOLOGY

Advanced Driving Dynamics	32
Added Driver Confidence	34
Advanced Drivetrain Technology	37
Torque Vectoring	39
Stability and Control	41

TECHNOLOGY

Infotainment	43
Connectivity	44
Audio	48

SAFETY AND EFFICIENCY

Driver Assistance	50
-------------------	----

XF 300 SPORT EDITION

52

PERSONALISATION

XF - Your Choice	54
Choose your Engine	56
Choose your Model	60
Choose your Options	62
Choose your Colour	70
Choose your Wheels	72
Choose your Interior	74
Choose your Jaguar Gear - Accessories	88

TECHNICAL DETAILS

96

SPECIAL VEHICLE OPERATIONS

102

THE WORLD OF JAGUAR

104

AT YOUR SERVICE

107

VEHICLES SHOWN: XF SPORTBRAKE S IN YULONG WHITE AND XF SALOON R-SPORT IN CORRIS GREY WITH OPTIONAL FEATURES FITTED

VEHICLES SHOWN ARE FROM THE JAGUAR GLOBAL RANGE. SPECIFICATIONS, OPTIONS AND AVAILABILITY WILL VARY BETWEEN MARKETS AND SHOULD BE VERIFIED WITH YOUR LOCAL JAGUAR RETAILER





INTRODUCTION

THE CONCEPT OF XF

XF builds on the success of Jaguar's most award-winning car ever. Possessing an unrivalled combination of style and substance, it delivers an utterly seductive blend of design, dynamics and refinement to create a car that offers both excitement and efficiency. All enhanced by state-of-the-art technologies that help keep you safe, connected and entertained.

XF sits in the Jaguar range between XE's taut athleticism and the supreme luxury of XJ. The fusion of these outstanding Jaguar attributes is what creates XF - the most dynamic, premium business car of its generation. New XF Sportbrake complements XF Saloon's distinctive 'coupé' lines and dynamism with even greater space and versatility.

VEHICLES SHOWN: XF SPORTBRAKE S IN YULONG WHITE AND XF SALOON R-SPORT IN CORRIS GREY WITH OPTIONAL FEATURES FITTED



XF - THE FACTS

An outstanding combination of advanced engineering, the latest technology and contemporary design sets XF apart.

EFFICIENCY AND PERFORMANCE

Find your perfect balance of economy and power in the XF Saloon and XF Sportbrake engine range. Many engines feature our Ingenium technology, including the 2.0 litre 4-cylinder 163PS Manual Turbocharged Diesel that can achieve CO₂ emissions from 129g/km¹ and economy up to 57.6 mpg¹. XF's most powerful Petrol engine, the 2.0 litre 4-cylinder 300PS Turbocharged, can sprint from 0-60mph in 5.6 seconds¹ and reach a top speed of 155mph.

REAR AIR SUSPENSION

Even when fully loaded, XF Sportbrake's comfort and precise handling is maintained by self-levelling rear air suspension. This system automatically inflates air springs to counteract the weight of heavy loads; this helps ensure a level chassis and ride height.

DYNAMIC DESIGN

With a sleek, low swooping roofline and optional 1.6m² panoramic glass roof, XF Sportbrake makes no compromise between assertive style and versatility. Perfectly executed to carry more, its proportions have been shaped to achieve aerodynamic excellence.



ADDED INTELLIGENCE

Innovative technologies make every drive easier and safer. XF offers Adaptive LED headlights, Traffic Sign Recognition and Adaptive Speed Limiter, Lane Keep Assist and Driver Condition Monitor, Emergency Braking, Adaptive Cruise Control with Queue Assist, Park Assist and Blind Spot Assist. With Powered gesture boot lid/tailgate you can access the boot when your hands are full. Simply present your foot under either rear corner and the boot opens or closes.

¹Engine performance and efficiency figures representative of XF Saloon only. For detailed XF Saloon and XF Sportbrake Technical Specifications, see pages 96 to 99.

²40:20:40 split fold rear seats are standard on XF Sportbrake.

³Feature only available with CD/DVD Player and Meridian™ Sound System.

⁴XF Saloon only. Drag coefficient for XF Sportbrake is Cd 0.29.

Some features described here are optional and market dependent. All figures are manufacturer's targets and subject to final confirmation ahead of production. Note that CO₂ and fuel economy figures can vary according to wheel fitment, and the lowest figures may not be achievable with the standard wheels.

VEHICLES SHOWN: XF SPORTBRAKE S IN YULONG WHITE AND XF SALOON R-SPORT IN CORRIS GREY WITH OPTIONAL FEATURES FITTED

CRAFTSMANSHIP AND SPACE

Contemporary craftsmanship and a luxurious, practical interior with the space to stretch out and enjoy every journey. Your front and rear passengers will appreciate leg, knee and headroom that are among the best in class. You can choose the optional 40:20:40 rear seating² configuration for increased volume and versatility.

CONNECTIVITY

Every drive in XF is enhanced by InControl technologies. InControl is a suite of products and services that connects you with your XF and links XF to the wider world. It ensures you are always in touch. With the option of Dual View³, front passenger and driver can enjoy different media on the same Touchscreen.

LIGHTWEIGHT ALUMINIUM ARCHITECTURE

XF's Lightweight Aluminium Architecture creates an incredibly strong body that delivers precise and responsive sports handling with impressive fuel efficiency.

ADVANCED DRIVETRAIN TECHNOLOGY

XF offers Jaguar's unique All Wheel Drive with Intelligent Driveline Dynamics (IDD) and Adaptive Surface Response (AdSR) on both petrol and diesel models. This maximises the legendary Jaguar handling, agility and ride, and gives added confidence in all conditions.

ADVANCED AERODYNAMICS

XF is capable of achieving a drag coefficient of just Cd 0.26⁴. Even the underside of the car is aerodynamically designed to be as smooth as possible, while apertures in the front bumper optimise airflow through the wheel arches. XF cuts through the air, reducing wind noise for enhanced refinement and improved efficiency.





DESIGN EXTERIOR PRINCIPLES



DESIGN PURITY

ADAPTIVE LED HEADLIGHTS

"It's about paring it down to the bare essentials. Good designers have always said less is more."
Ian Callum, Jaguar Design Director.

XF demonstrates the Jaguar principles of design purity. Strong lines radiate dynamic character and enhance its capabilities – be it improving aerodynamics, visibility, stability or safety. XF is available with Adaptive LED headlights* featuring Jaguar signature 'J' blade Daytime Running Lights to give XF a striking on road presence. The quality of LED light is close to daylight, helping your eyes to distinguish objects more easily and reducing fatigue at night.

*Optional feature. Xenon headlights are standard on all XF models.

VEHICLE SHOWN RIGHT: XF SALOON R-SPORT IN CORRIS GREY WITH OPTIONAL FEATURES FITTED



776 XCN

EXTERIOR AERODYNAMICS



AERODYNAMIC DESIGN

F-TYPE INSPIRED DESIGN

XF's sweeping exterior design is naturally aerodynamic. Its advanced form enhances handling, dynamics and refinement. Airflow is carefully managed through and around the car. Intakes either side of the front grille draw air in, then channel it out from the wheel arches to reduce turbulence. As air flows along the car, pressure differences that can cause drag are minimised by the flush, aerodynamically optimised sides.



At the rear, XF's tail lights feature a distinctive, F-TYPE inspired roundel and intersecting horizontal detail. The LED brake lights are not only brighter than halogen bulbs, they use less energy – contributing to XF's overall drive for greater efficiency. LEDs also illuminate faster – so following drivers can react more quickly to XF's braking. Within the tail lights is a pinstripe graphic – one of XF's many exquisite finishing touches.

VEHICLES SHOWN: XF SPORTBRAKE S IN YULONG WHITE AND XF SALOON R-SPORT IN CORRIS GREY WITH OPTIONAL FEATURES FITTED





JAGUAR

140 180 200 220 240 260 280 300
0 km/h
1 2 3 4 5
P



HOME 14:56

Navigation	Media	Phone
Arlington Avenue Leamington Spa 55km 16:55	Bluetooth audio Young Before Your Time Corvidae	My iPhone

21.5 16.5

SYNC MAX MAX A/C A/C

START STOP

P R N D S



INTERIOR

**> DRAMATIC
START-UP SEQUENCE**

**CONTEMPORARY
CRAFTSMANSHIP**

Open XF's door and the Start button entices you inside. Pulsing with a heartbeat it creates an emotional connection between driver and machine. Its 72 per minute double beat is the same as a jaguar cat at rest. XF is poised, ready for action. Now push the Start button. The car awakens and its mood lighting illuminates. With perfect choreography, air vents rotate open, the JaguarDrive Selector rises smoothly, and the engine growls - all inspiring you to anticipate the drive ahead.

XF's interior offers outstanding comfort, a sense of wellbeing and a wealth of choice. The number of switches and buttons is kept to a minimum to keep the look clean and tidy, as well as making them easy to use. Whichever XF interior combination you choose, materials used are always of the highest quality. Leather and finishes are selected with the greatest care to ensure that, inside XF, everything is luxurious to the touch. Whether you prefer aluminium, carbon fibre, or wood veneer finishes to complement the beautiful selection of leathers, your XF will always look and feel just right.

To enhance the cabin's sense of wellbeing, XF Sportbrake offers a new Cabin Air Ionisation system that improves air quality. With this optional system, air is passed through an ioniser that filters and purifies the airflow before it is circulated within the cabin. This neutralises odours as well as minimising bacteria for a more pleasant and healthy in-car environment.

INTERIOR SHOWN: XF SALOON S FEATURING LIGHT OYSTER/EBONY SEATS WITH EBONY UPPER FACIA WITH CONTRAST STITCH, EBONY CARPET AND EBONY HEADLINING WITH OPTIONAL FEATURES FITTED





1. Headroom 957mm (991mm¹ on XF Sportbrake) 2. Knee room 87mm

INTERIOR SPACE



GENEROUS REAR SPACE

IMPRESSIVE VERSATILITY

In both XF Saloon and Sportbrake, the rear of the cabin is a destination of luxury, choice and space. The generous rear knee room is among the best in class, while the ample rear legroom and rear headroom give you room to relax. It all adds up to greater comfort and wellbeing for passengers.

Interior lighting also enhances XF's atmosphere. Opt for Configurable Ambient Interior Lighting and you'll have a choice of ten interior colours. The choice continues with optional Four-zone Climate Control, giving individual passengers the opportunity to set their own temperature and airflow.

At 540 litres, the loadspace of XF Saloon offers plenty of carrying capacity. For even greater versatility, choose the optional 40:20:40 rear seating configuration² - it increases loadspace to an impressive 885 litres. This outstanding practicality is taken to the next level in XF Sportbrake.

¹989mm with optional fixed panoramic roof on XF Sportbrake. ²Standard feature on XF Sportbrake.

INTERIOR SHOWN: XF SALOON S FEATURING LIGHT OYSTER/EBONY SEATS WITH EBONY UPPER FACIA WITH CONTRAST STITCH, EBONY CARPET AND EBONY HEADLINING WITH OPTIONAL FEATURES FITTED



SPACE AND VERSATILITY



SUBSTANTIAL LOADSPACE

ACTIVITY KEY

XF Sportbrake's versatile interior is designed to meet the demands of your lifestyle. Its loadspace provides up to 565 litres of space with the rear seats in place. Fold the rear seats down, and you'll create a space that is two metres in length and over a metre in width at its narrowest point, featuring 1,700 litres of luggage capacity plus discreet underfloor stowage.

To make everything that bit easier, XF Sportbrake offers a powered tailgate as standard, and a Powered gesture tailgate and Activity Key as options. Activity Key is a robust and fully waterproof wristband that allows you to enjoy a range of activities - from skydiving to swimming - while giving you immediate access to the car at all times. The conventional key fob can remain within the car as it is deactivated for security purposes.

INTERIOR SHOWN: XF SPORTBRAKE S FEATURING BROGUE SEATS WITH CONTRAST STITCH, EBONY CARPET AND EBONY HEADLINING WITH OPTIONAL FEATURES FITTED

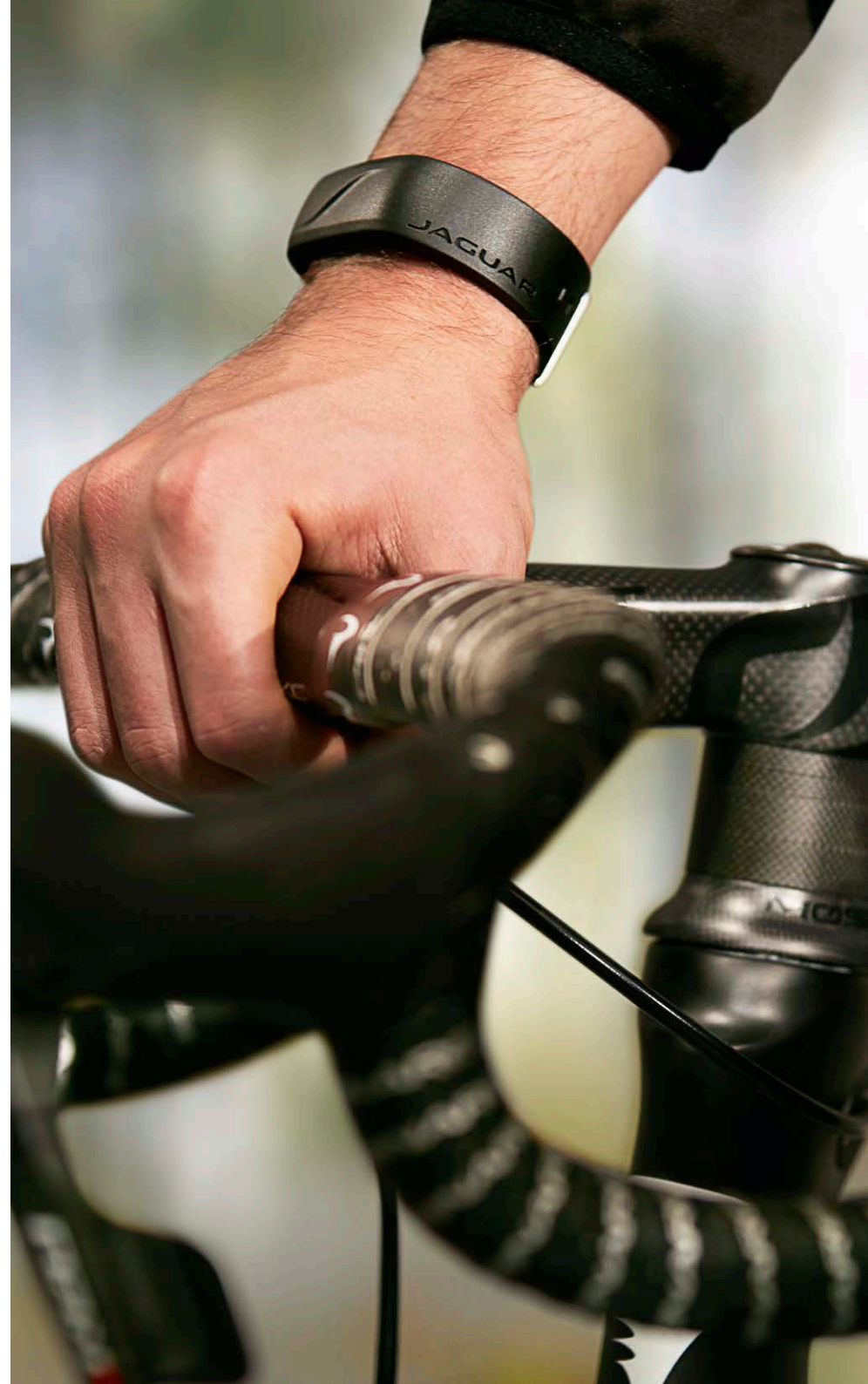

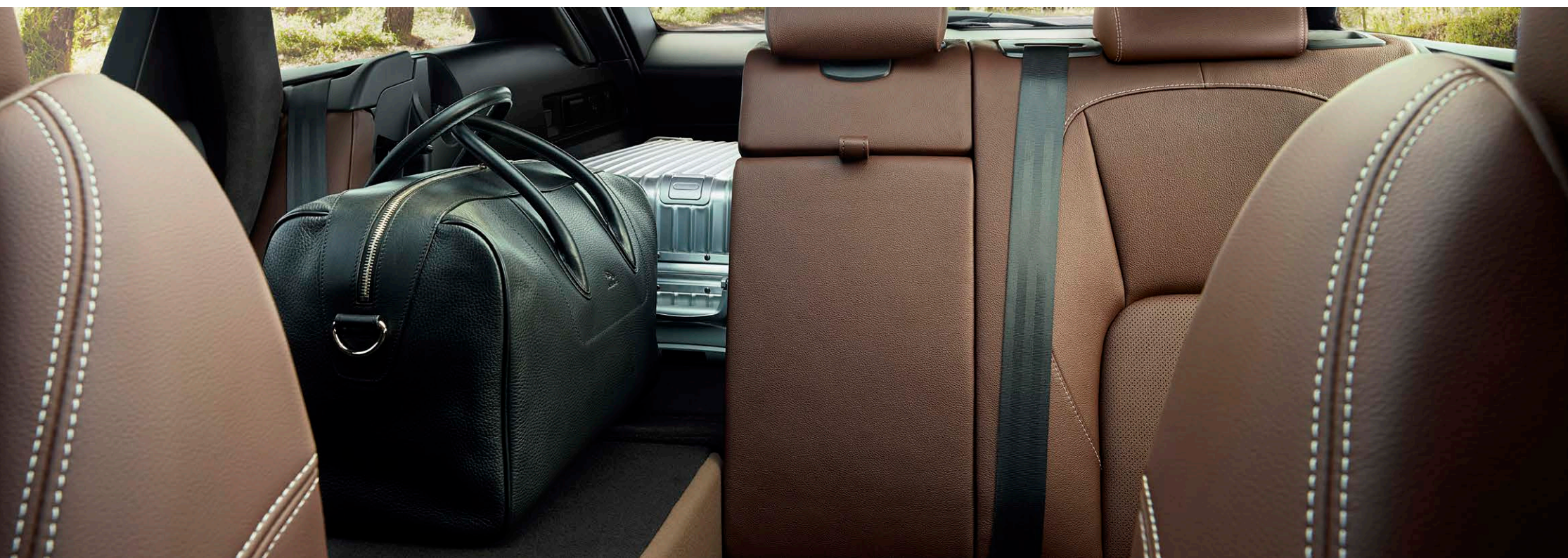



40:20:40 SPLIT FOLD SEATS

FIXED PANORAMIC ROOF

XF Sportbrake's rear seats fold completely flat or can be divided with a 40:20:40 split*, using a thoughtfully placed remote release that's accessible from the tailgate area. Easy-to-use loadspace rails help further increase the adaptability of loadspace stowage, and a divider net prevents objects from falling onto the rear seats.

Introducing even more natural light and airiness to the interior, XF Sportbrake's optional 1.6m² fixed panoramic roof has the largest single piece of roof glass in its class. There's also the option of a gesture roof blind that can be opened and closed with a simple swipe of your hand without you ever having to take your eyes off the road.

*Standard on all XF Sportbrake models. Standard on Portfolio and S models on XF Saloon.

INTERIOR SHOWN: XF SPORTBRAKE S FEATURING BROGUE SEATS WITH CONTRAST STITCH, EBONY CARPET AND EBONY HEADLINING WITH OPTIONAL FEATURES FITTED

PERFORMANCE ENGINES OVERVIEW



INGENIUM ENGINES

STOP/START TECHNOLOGY

Ingenium technology underpins three of the diesel engines in the XF range. These low friction, all-aluminium engines have stiff cylinder blocks and twin balancer shafts to ensure inherently low levels of vibration, for smooth day-to-day performance. All engines are equipped with Stop/Start technology and smart regenerative charging – harvesting kinetic energy from braking to charge the battery – for maximum economy, especially during urban driving. XF's diesel engines are available with either a 6-speed Manual Transmission that provides slick, short changes or an 8-speed Automatic Transmission that is highly responsive, smooth and efficient. For information on transmission availability, fuel consumption, CO₂ emissions and performance figures for XF's engines, please refer to pages 96 to 99.



AdBlue®

INGENIUM DIESEL ENGINES FROM

129g/km CO₂*

The **Ingenium 2.0 litre 4-cylinder 163PS Turbocharged Diesel** is refined and efficient. Low-flow direct injectors precisely control the amount of fuel that enters the combustion chamber for maximum efficiency. Intelligent, electronically controlled, adaptive engine cooling only engages when required – minimising fuel consumption and CO₂ emissions. This doesn't limit driving pleasure, the engine's strong torque gives good performance from low down in the rev range for brisk acceleration.

The **Ingenium 2.0 litre 4-cylinder 180PS Turbocharged Diesel** offers performance and economy. For an engine of this size it offers high levels of torque, but not at the expense of efficiency – a balance achieved thanks to its variable geometry turbocharger. Adapting to the changing flow of exhaust gases, it maximises low speed torque for broad power and responsiveness that is uniform, progressive and avoids lag.

The **Ingenium 2.0 litre 4-cylinder 240PS Twin Turbocharged Diesel** delivers high power and torque. Its series sequential twin turbocharger uses high and low pressure spools to give continuous acceleration and maximise performance. A higher specific power output is created by building on Ingenium technology. Upgrades include a higher pressure common rail fuel system, increased from 1,800 to 2,200 bar, and an improved fuel injector flow rate.

*Engine performance and efficiency figures representative of XF Saloon only. For detailed XF Saloon and Sportbrake technical specifications, see pages 96 to 99.

All figures are manufacturer's targets and subject to final confirmation ahead of production. Note that CO₂ and fuel economy figures can vary according to wheel fitment, and the lowest figures may not be achievable with the standard wheels.

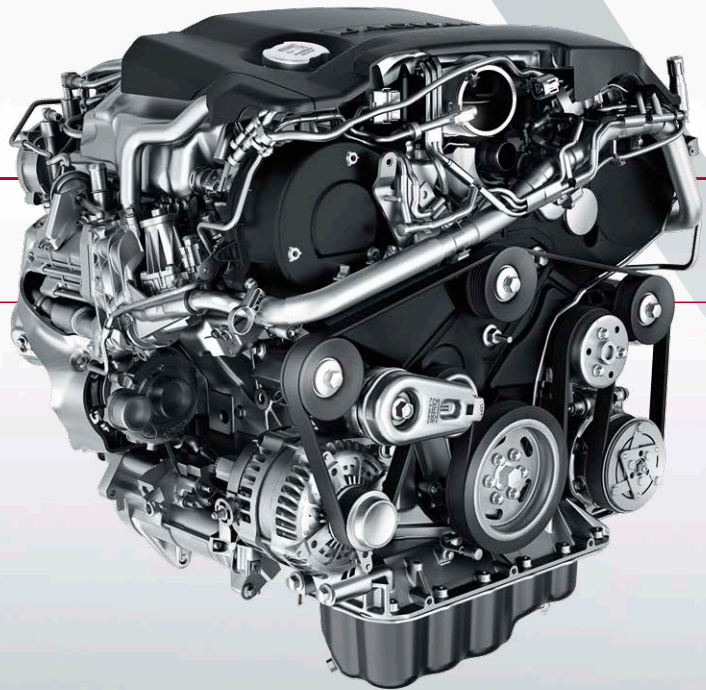

AdBlue®

DIESEL ENGINE

0-60mph in 6.0 seconds*

The **3.0 litre V6 300PS Twin Turbocharged Diesel** engine offers exceptional power, torque and drivability. It uses innovative twin-parallel sequential turbocharging - a concept pioneered by Jaguar Land Rover - for smooth, more immediate delivery of power at all engine speeds, as well as two-stage water cooling to conserve energy.

XF offers a choice of two petrol engines from our Ingenium range. With their lightweight, all-aluminium design, and widespread use of low-friction roller bearings, Ingenium petrol engines are built for smooth, highly efficient performance. To guarantee a responsive drive and effortless acceleration, every XF petrol engine makes use of a rapid-shifting, 8-speed Automatic Transmission. All engines are equipped with Stop/Start technology* and smart regenerative charging – harvesting kinetic energy from braking to charge the battery – for maximum economy, especially during urban driving. For information on transmission availability, fuel consumption, CO₂ emissions and performance figures for XF's engines, please refer to pages 96 to 99.

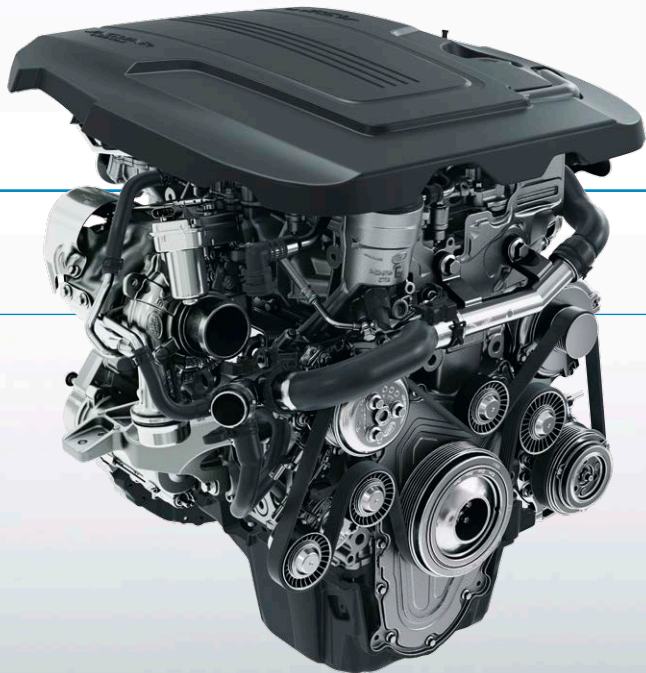

INGENIUM PETROL ENGINES UP TO

0-60mph in 5.6 seconds*

The **Ingenium 2.0 litre 4-cylinder 250PS Turbocharged Petrol** engine delivers outstanding usable power and torque. For excellent acceleration and effortless overtaking, maximum torque is available between 1,300-4,500rpm. This engine's twin scroll turbocharger is fed by an integrated exhaust manifold that synchronises exhaust pulses from two separate pairs of cylinders – significantly reducing turbo lag and improving engine response.

The **Ingenium 2.0 litre 4-cylinder 300PS Turbocharged Petrol** engine's impressive power is balanced with strong fuel economy. For almost instant boost and high efficiency, its low inertia twin-scroll turbocharger features low-friction ball bearings and a high flow compressor wheel. Underpinned by the turbocharger's increased aerodynamic efficiency, the engine delivers rapid acceleration and maximum torque of 400Nm between 1,500-4,500rpm.

*Engine performance and efficiency figures representative of XF Saloon only. For detailed XF Saloon and Sportbrake technical specifications, see page 96 to 99.

All figures are manufacturer's targets and subject to final confirmation ahead of production. Note that CO₂ and fuel economy figures can vary according to wheel fitment, and the lowest figures may not be achievable with the standard wheels.



ADVANCED AERODYNAMICS



LOW DRAG

| CD 0.26*

XF's form has been rigorously optimised for aerodynamic efficiency and stability at motorway speeds. With a drag coefficient as low as Cd 0.26*, XF cuts through the air - reducing fuel consumption and lowering emissions. Every element exploits the exterior's maximum aerodynamic potential while preserving XF's stunning proportions. Vertical apertures in the front bumper outer edges channel air through vents in the wheel arches and out over the front wheels. The airflow then passes along XF's sides where the doors have a flatter cross sectional profile to minimise air pressure differences and contribute further to reduced drag. Even the extensive under body protection is designed to make XF as efficient, economical and refined as possible.

*XF Saloon only. Drag coefficient for XF Sportbrake is Cd 0.29.

VEHICLE SHOWN: XF SALOON PORTFOLIO IN SANTORINI BLACK WITH OPTIONAL FEATURES FITTED



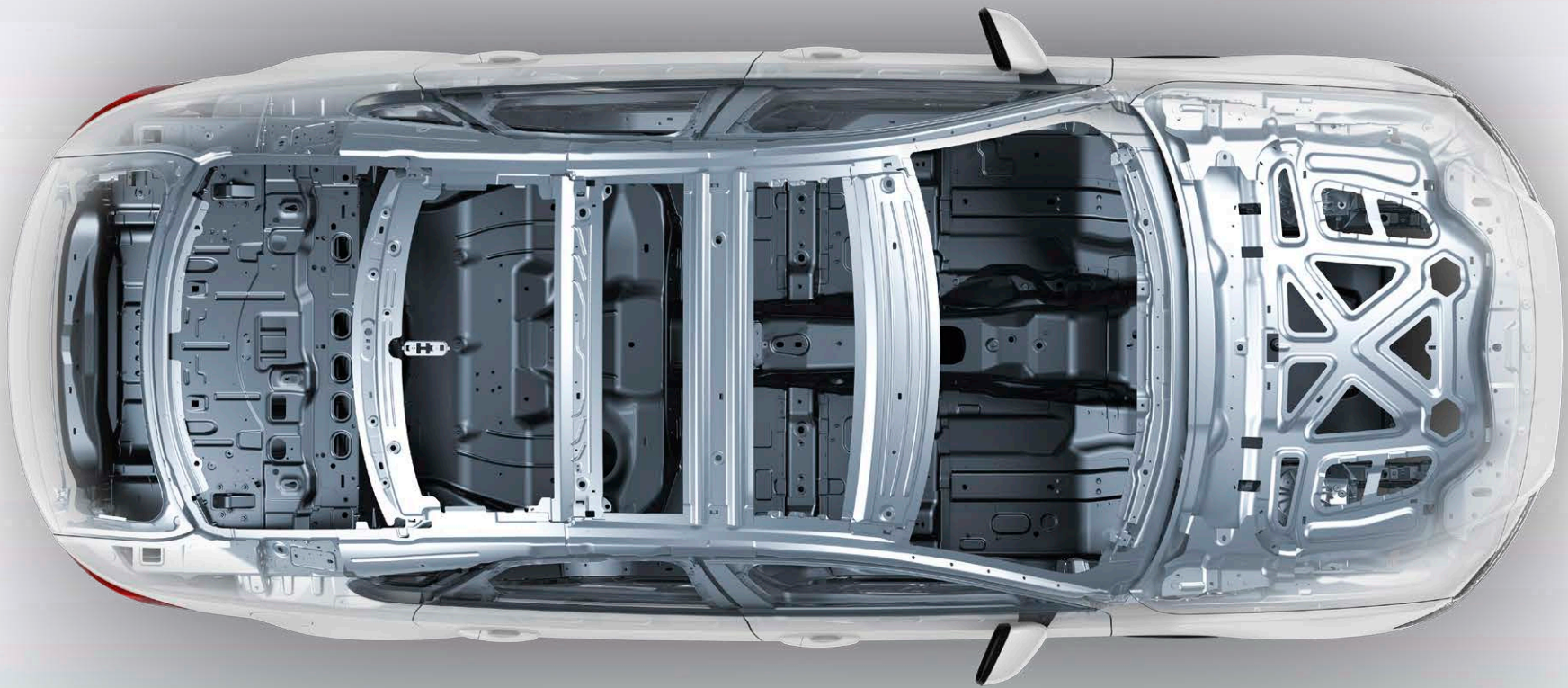

LIGHTWEIGHT ALUMINIUM ARCHITECTURE

 **STRONG** | **RIGID** | **75% ALUMINIUM**

Jaguar has been at the forefront of aluminium car construction for more than a decade. The latest innovation is our high-strength Lightweight Aluminium Architecture, which is not only incredibly strong and reduces weight, it is also extremely stiff - underpinning XF's precise, agile handling. Aluminium has also been used to form the body sides, bonnet and front wings. These panels are bonded together with a super-strong adhesive, then punched with zinc-coated, boron steel rivets that compress the adhesive to form an airtight bond and a phenomenally strong, rigid structure. This cutting-edge process, coupled with the Lightweight Aluminium Architecture, makes XF among the lightest cars in its class. This weight saving facilitates fuel efficiency up to 57.6mpg* and CO₂ emissions from 129g/km*.

*Engine performance and efficiency figures representative of XF Saloon only.
For detailed XF Saloon and XF Sportbrake Technical Specifications, see pages 96 to 99.

All figures are manufacturer's targets and subject to final confirmation ahead of production. Note that CO₂ and fuel economy figures can vary according to wheel fitment, and the lowest figures may not be achievable with the standard wheels.

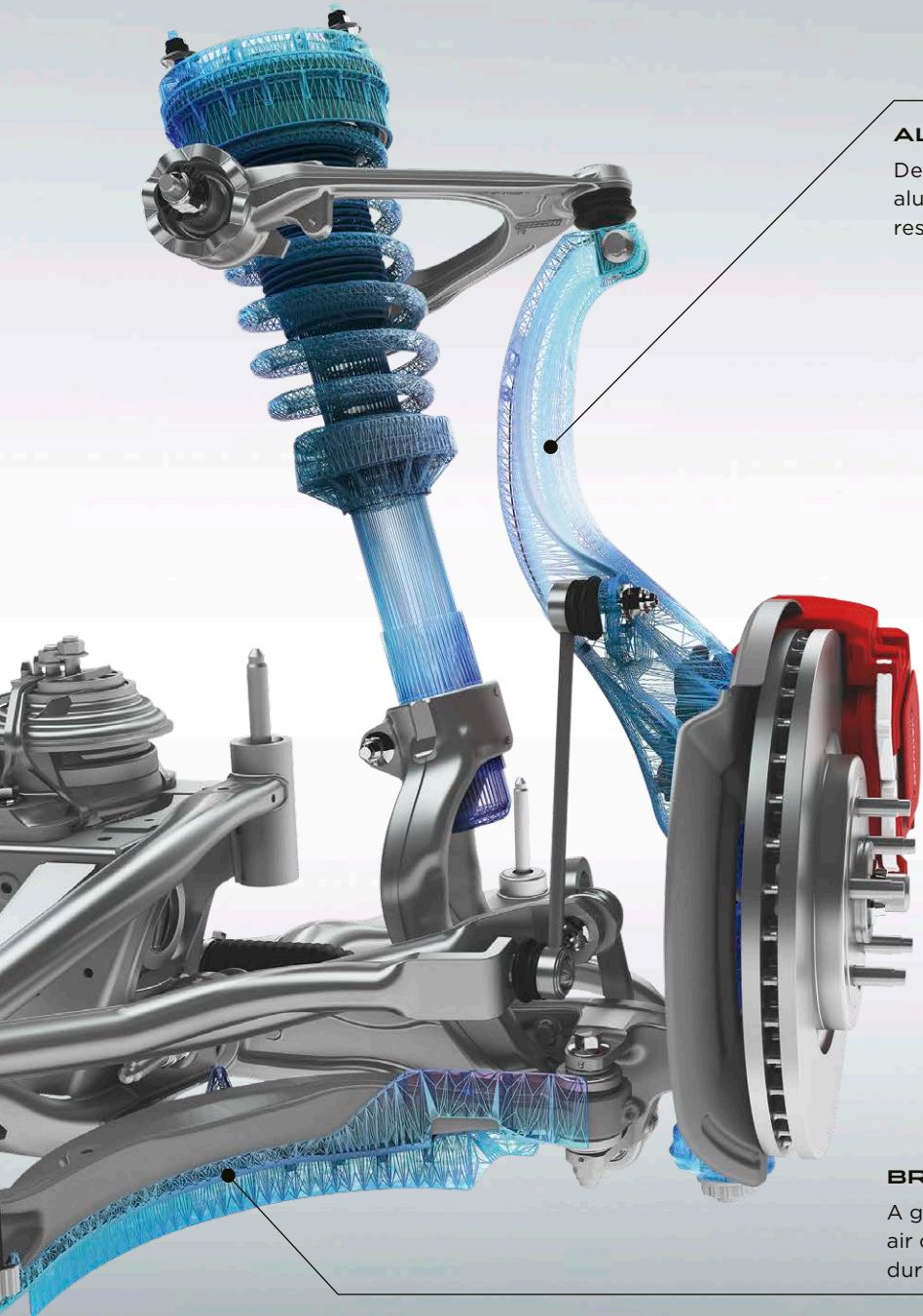

ALUMINIUM FRONT KNUCKLE

Designed to optimise stiffness and strength, the lightweight aluminium front knuckle helps improve XF's agility, responsiveness and refinement for sports car-like control.

CHASSIS AND SUSPENSION



UNIQUE SUSPENSION
TECHNOLOGY

COMFORTABLE
AND DYNAMIC

XF responds with agility and performs with dynamism while always maintaining ride comfort – it's a unique balance that makes it a Jaguar. The ideal foundation for these driving dynamics is XF's light, yet exceptionally strong and stiff, Lightweight Aluminium Architecture with its near 50:50 weight distribution.

The sophisticated front and rear suspension systems complete a chassis that achieves a superb combination of sportiness and refinement. Advanced damper technologies – both passive or adaptive – improve ride quality still further and extend XF's breadth of dynamic capability. The suspension's control, agility and feedback give XF the spirit of a sports car.

BRAKE SCOOP

A glass-filled polypropylene brake scoop channels air onto the brakes for enhanced brake performance during enthusiastic driving.

INTEGRAL LINK REAR SUSPENSION

Integral Link suspension allows XF to realise a perfect combination of a refined, luxurious ride and sharp, responsive handling. The system, the benchmark for this class of car, separates and independently manages the lateral, longitudinal and vertical forces acting on the suspension for enhanced control and comfort. Many components are forged or hollow-cast in aluminium – the optimum production techniques for strong, lightweight suspension.

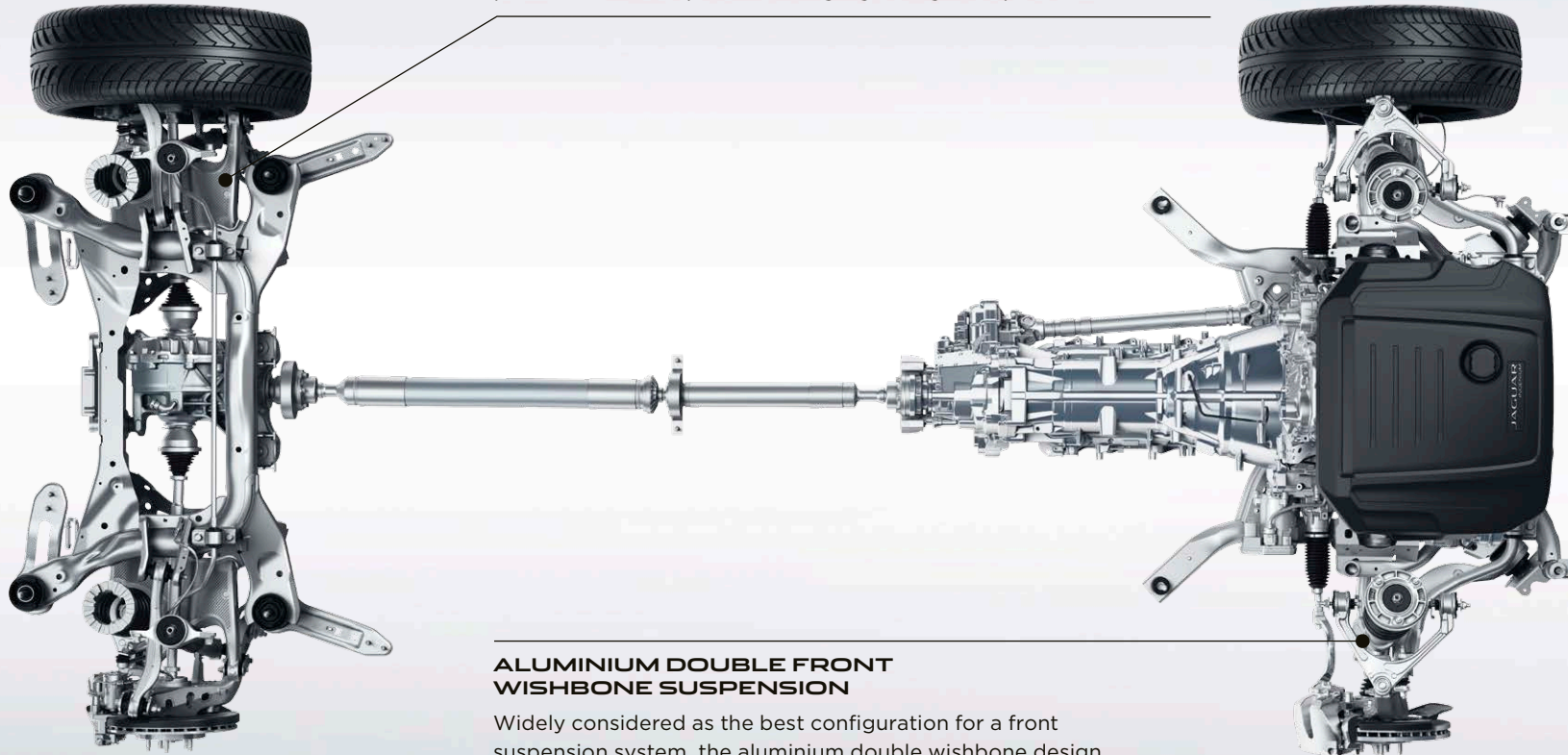

ALUMINIUM DOUBLE FRONT WISHBONE SUSPENSION

Widely considered as the best configuration for a front suspension system, the aluminium double wishbone design is modelled closely on F-TYPE's for precise handling and steering response.

DRIVING TECHNOLOGY

ADVANCED DRIVING DYNAMICS

> MAXIMISING AGILITY

Dynamic Mode revises the car's software to further enhance XF's sporting character. It sharpens the throttle response, increases steering weighting and performs gearshifts more quickly¹ and at higher engine speeds. It also brings visual drama to the driver as the instrument cluster takes on a red glow. Dynamic Mode enhances your connection with XF's inherent Jaguar performance.

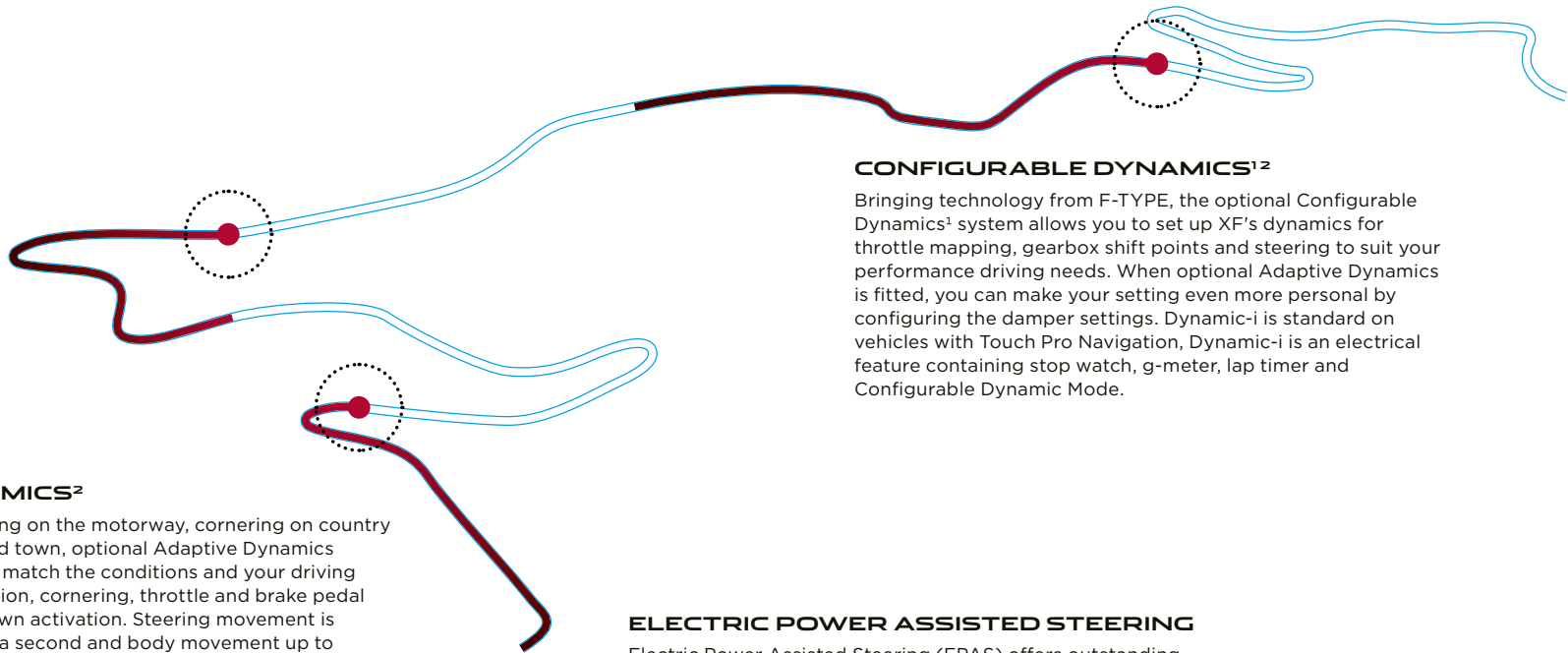

ADAPTIVE DYNAMICS²

Whether you're accelerating on the motorway, cornering on country roads or navigating around town, optional Adaptive Dynamics modifies XF's response to match the conditions and your driving style. It analyses acceleration, cornering, throttle and brake pedal activity, as well as kick-down activation. Steering movement is analysed up to 500 times a second and body movement up to 100 times a second. Using this information, electronically controlled adaptive dampers then constantly adjust to optimise the suspension settings and maintain XF's poise and comfort.

CONFIGURABLE DYNAMICS^{1,2}

Bringing technology from F-TYPE, the optional Configurable Dynamics¹ system allows you to set up XF's dynamics for throttle mapping, gearbox shift points and steering to suit your performance driving needs. When optional Adaptive Dynamics is fitted, you can make your setting even more personal by configuring the damper settings. Dynamic-i is standard on vehicles with Touch Pro Navigation, Dynamic-i is an electrical feature containing stop watch, g-meter, lap timer and Configurable Dynamic Mode.

ELECTRIC POWER ASSISTED STEERING

Electric Power Assisted Steering (EPAS) offers outstanding feedback, control and it is active on demand - saving power for where you really need it, as well as saving fuel. EPAS' sophisticated computer management varies steering assistance as appropriate - increasing assistance for low speed manoeuvring and improving feel at higher speeds. It also enables advanced safety features such as Lane Keep Assist³ and Park Assist³.

¹Automatic transmission only.

²Standard on XF S, not available on 2.0 litre 4-cylinder 163PS Diesel engine.

³Optional feature.



ADDED DRIVER CONFIDENCE



ALL SURFACE PROGRESS CONTROL¹

ADAPTIVE SURFACE RESPONSE

Unique in this class of car, Jaguar's All Surface Progress Control (ASPC) technology is a low speed cruise control that helps XF to cope with low traction situations. ASPC allows the driver to concentrate on steering the vehicle. Once activated, you use the cruise control buttons to set a 'target' speed of between 2mph and 19mph. The system then works to achieve and maintain that speed while exerting optimum traction control.

ASPC is standard on all engines fitted with automatic transmissions and gives XF drivers added confidence over slippery, loose or icy surfaces, undulating terrain and even while descending a difficult incline. It helps make XF easy to drive in challenging conditions. ASPC also has a pull-away function allowing XF to progress from rest on low grip surfaces and ascending gradients, as well as a hill descent function that controls vehicle speed on steeper inclines.

On All Wheel Drive vehicles fitted with Adaptive Dynamics², optional Adaptive Surface Response (AdSR) recognises differences between surfaces to exploit the maximum available grip. Drawing on Jaguar Land Rover's unrivalled expertise with All Wheel Drive systems, AdSR constantly monitors the car's environment and adjusts the appropriate engine and brake settings. Once selected, AdSR works at all speeds to support you in adverse weather and across challenging surfaces.

¹Automatic transmission only.

²Standard on XF S, not available on 2.0 litre 4-cylinder 163PS Diesel engine.

With any given set of tyres, ASPC can accomplish comparable levels of traction to that achievable by an expert driver. Fitting All-season or Winter tyres to XF can improve capability on slippery surfaces.

GRAVEL



WET GRASS



SNOW/ICE



WET ROAD



HBS 991

JAGUAR

XF

ADVANCED DRIVETRAIN TECHNOLOGY



ALL WHEEL DRIVE

INTELLIGENT DRIVELINE DYNAMICS

XF's All Wheel Drive (AWD) system combines the agility and character of Rear Wheel Drive (RWD) with the increased security and traction provided by AWD. In normal driving, XF is predominantly RWD to deliver handling purity, feel and balance. But when roads become more challenging, or when you accelerate more keenly on low-grip surfaces, the system subtly channels power forwards enabling XF to maintain optimum traction for comfortable progress in all conditions.

XF's AWD uses a transfer case at the back of the 8-speed Automatic Transmission to manage the appropriate distribution of torque to the front and rear wheels. Engineered to ensure that XF retains the dynamic behaviour of a Jaguar, the transfer case contains an electro-mechanically activated multi-plate clutch with an actuator to build hydraulic pressure. This pressure is quickly and accurately controlled to generate the required force in the clutch to transfer the optimal amount of torque to the front wheels.

Unlike other systems that react to wheel slip, Jaguar's Intelligent Driveline Dynamics (IDD) software is predictive and uses sensors measuring throttle and steering inputs to anticipate wheel slip. IDD seamlessly co-ordinates these inputs and compares them with responses from the engine, transmission and traction control systems to calculate the traction available and distribute torque accordingly even before grip is lost. From a standstill XF can transition from RWD to AWD in as little as 165 milliseconds or just 100 milliseconds when the car is moving. The result is a drive which blends the character of RWD with the capability of AWD, providing outstanding levels of performance and control whatever the road throws at you.

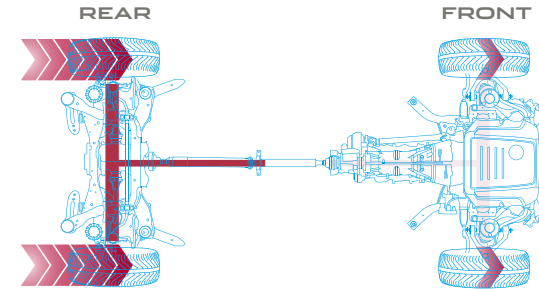

DRY ROAD CONDITIONS

In normal conditions, torque is distributed to the rear wheels, delivering acclaimed Jaguar agility and handling.

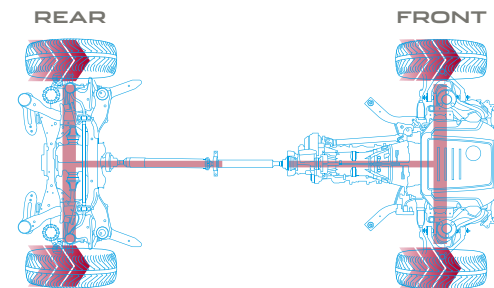

LOW TRACTION CONDITIONS

On slippery surfaces, such as grass and snow, torque can be balanced between the front and rear wheels to maximise traction. In extreme conditions where only the front wheels have traction, up to 100 percent of engine torque can be distributed to the front wheels for optimum grip.



TORQUE VECTORING

➤ MAXIMISED CORNERING CAPABILITY

XF's Torque Vectoring by Braking maximises capability through even the tightest corners. Torque Vectoring technology provides controlled independent braking on the individual inside front and rear wheels to add to the turning forces acting on the car. In most conditions more braking pressure is applied to the rear inside wheel as this supports the most increased cornering capability, while the front inside wheel is braked for greater effectiveness and refinement. The result is reduced understeer for sharper turning and more consistent road holding. Torque Vectoring delivers increased sports car-like agility and added driver confidence.

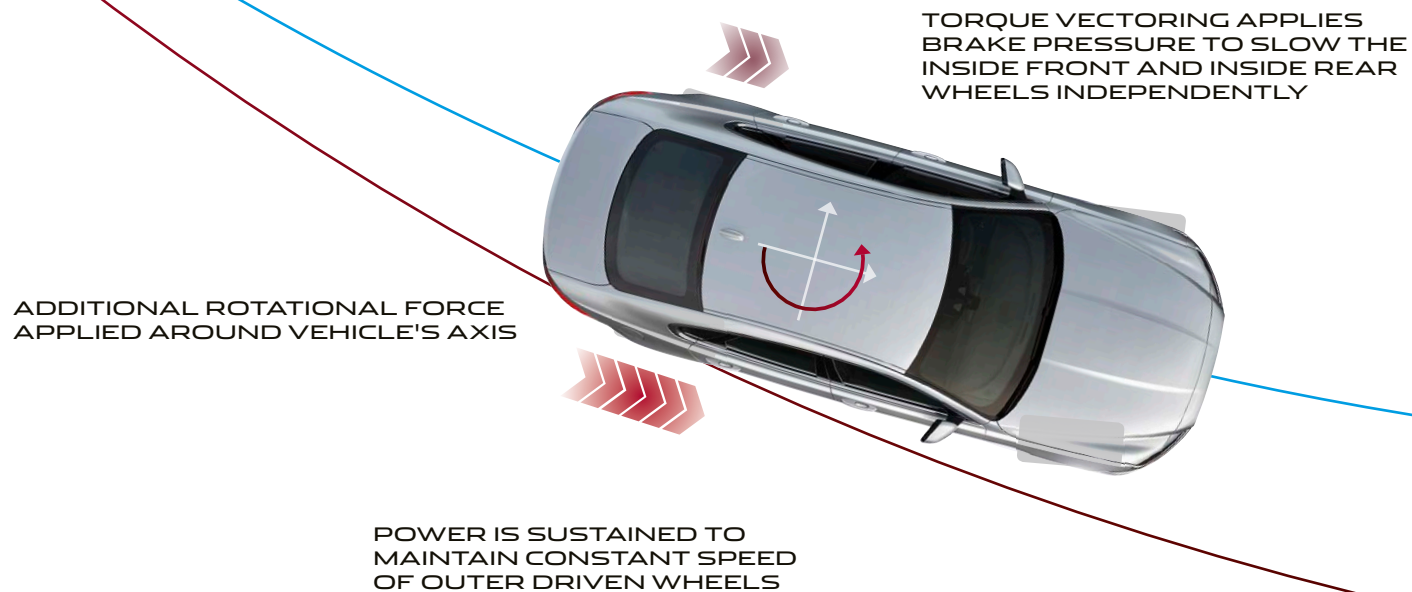

Graphical representation only.

VEHICLE SHOWN PREVIOUS PAGE: XF SALOON S IN YULONG WHITE WITH OPTIONAL FEATURES FITTED



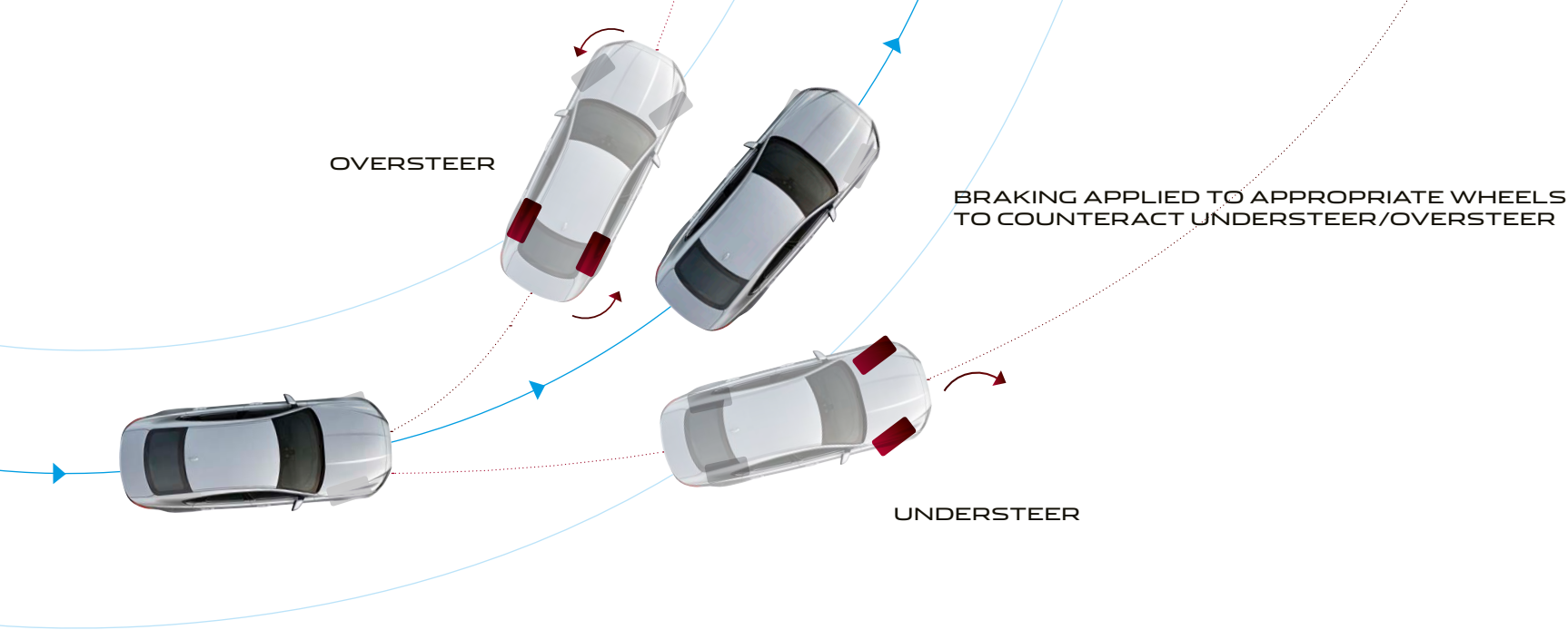

STABILITY AND CONTROL



**DYNAMIC
STABILITY CONTROL**

**ENGINE DRAG
TORQUE CONTROL**

**TRAILER
STABILITY ASSIST**

Jaguar's Stability Systems keep XF safely balanced whether you're driving enthusiastically or simply want the assurance of a car that will remain stable in challenging conditions.

Dynamic Stability Control (DSC) monitors XF's dynamic behaviour, intervening to maximise vehicle stability and optimising available grip. DSC reduces engine torque and applies braking to the appropriate wheels to correct the car's direction of travel by counteracting understeer or oversteer. XF's DSC system has enhanced understeer control to reduce speed and regain control more effectively.

Engine Drag Torque Control (EDC) mitigates the chance of wheel lock-up caused by strong engine braking in slippery conditions. It acts by briefly increasing torque to the driven wheels as appropriate.

Trailer Stability Assist (TSA) gives you greater stability when towing. Should TSA detect a dangerous trailer sway situation is developing, it can help you regain control by gradually reducing XF's speed through lowering engine power and applying the brakes individually on each side of the vehicle to control the sway.

Graphical representation only.

VEHICLE SHOWN PREVIOUS PAGE: XF SALOON S IN YULONG WHITE WITH OPTIONAL FEATURES FITTED



JAGUAR

140 160 180
100 200 220
80 240 260
60 280 300
20

0 km/h

3 4
2 5
1 6
7

P

HOME 14:56

Navigation
Arlington Avenue
Leamington Spa
65km 16:55

Media
Bluetooth audio
Young Before Your Time
Corvidae

Phone
My iPhone

Navigation icons: Home, Search, Navigation, Media, Phone, Bluetooth, P, Power, Screen Off

21.5 16.5

SYNC WINDSCREEN WIPERS TRAFFIC JAM ASSISTANCE SEAT HEATING AUTO

MAX WIPERS MAX A/C A/C

START ENGINE STOP

Power button

P R N D S

ECO

TECHNOLOGY INFOTAINMENT

Delivering a wealth of information and entertainment, every XF is equipped with our InControl infotainment system, Touch Pro. It features intuitive and advanced integrated technologies to ensure everyone can make the most of their journey.



10" TOUCH PRO

The standard 10" Touchscreen at the heart of the centre console supports tap, swipe and pinch to zoom gestures and delivers our richest ever audio-visual entertainment. To enhance the in-car experience, Touch Pro offers customisable homescreens and fast response times as well as voice control. Multi-tasking is also made easy thanks to the Interactive Side Panel.



INTERACTIVE DRIVER DISPLAY

The optional 12.3" high-definition Interactive Driver Display can receive and project a vast amount of driving information, entertainment and active safety data including navigation, phone and media. Its high resolution ensures the utmost clarity and its refined processing engine delivers smooth moving pin sharp graphics. To help you find your way more easily, Navigation Pro enables you to display full screen navigation with 3D mapping.

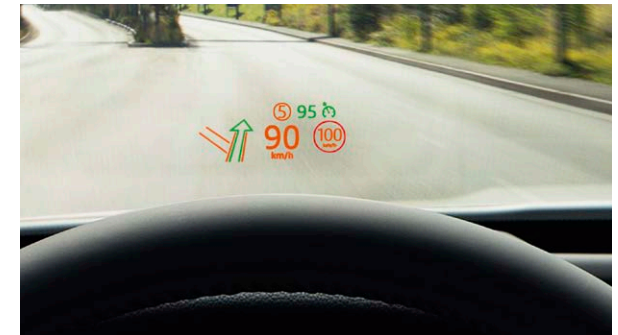

HEAD-UP DISPLAY

To help reduce distraction or the need for you to take your eyes off the road, Head-up Display* is an option that presents key vehicle data such as your speed, gear position and navigation directions on the windscreen. It features crystal clear colour graphics in high resolution, enabling you to see all information with ease. The feature can be turned on and off dependent on driver preference.

*Requires Solar attenuating windscreen to be fitted.

Remote contains subscription services that can be extended after the initial term advised by your Jaguar Retailer. InControl features, options and their availability remain market dependent - check with your Jaguar Retailer for local market availability and full terms. Information and images displayed in relation to the InControl technology, including screens or sequences, are subject to software updates, version control and other system/visual changes depending on options selected. Mobile network connectivity cannot be guaranteed in all locations. InControl Apps and Remote App will need to be downloaded from the Apple/Google Play Store. All in-car features should be used by drivers only when safe for them to do so. Drivers must ensure they are in full control of the vehicle at all times. Stay connected while on the move your new Jaguar XF will arrive with a SIM Card equipped with an Essential data plan of 500MB of data per month for the initial warranty period. You'll be better connected, receiving live traffic updates and more. Additional data can be purchased.

CONNECTIVITY

InControl is Jaguar's suite of standard and optional features that connects you to your vehicle and links you seamlessly, and securely, with the outside world. There are a range of packs and options available to choose from. With a selection of apps, even when you're away from your car, some of the InControl features stay with you, making sure the Jaguar experience is more enjoyable than ever.

STANDARD FEATURES

PINPOINT TOUCH CONTROL

Pinpoint touch control allows you to interact with information swiftly. The Touchscreen responds in the same manner as a smartphone or tablet computer, providing multi-touch gestures such as pinch to zoom and swipe.

PERSONALISED HOMEPAGE

You can set up your homescreens the way you want them. With over 60 shortcuts and widgets, you can customise your system around the features you use most.

INTERACTIVE SIDE PANEL

A choice of side panels means you can multi-task. For example, your main screen area can be used for navigation, while the side panel provides phone controls. Simply swipe up and down to switch between multiple panels.

MULTIMEDIA

Enjoy a range of multimedia features on the Touchscreen. Connect your device and see details of playlists and music displayed by artist, album and genre.

ENHANCED PHONE INTERFACE

Making it easier and safer, you can call a favourite contact with a single touch via the customisable homepage. Additional functionality includes direct access to voicemail, conference calling and homescreen integration.

VOICE RECOGNITION SYSTEM

So you can complete tasks without taking your eyes off the road, XF offers intelligent voice recognition. For example, 'Tune to 97.9', 'Call office' or 'Navigate home'.

Remote contains subscription services that can be extended after the initial term advised by your Jaguar Retailer. InControl features, options and their availability remain market dependent - check with your Jaguar Retailer for local market availability and full terms. Information and images displayed in relation to the InControl technology, including screens or sequences, are subject to software updates, version control and other system/visual changes depending on options selected. Mobile network connectivity cannot be guaranteed in all locations. InControl Apps and Remote App will need to be downloaded from the Apple/Google Play Store. All in-car features should be used by drivers only when safe for them to do so. Drivers must ensure they are in full control of the vehicle at all times.



PROTECT

Jaguar Optimised Assistance - If you break down you can make a direct call to the Jaguar Assistance team by pressing the button on the overhead console or from the Assistance screen within the Remote smartphone app.

SOS Emergency Call - In a more serious incident, SOS Emergency Call will automatically connect you to the emergency response team who will notify the emergency services to your location. For peace of mind, this service is provided for the first ten years from date of registration.

Remote Essentials - Remote smartphone app provides information on your vehicle and enables you to interact with it remotely. Compatible with most smartphones, Android Wear™ or the Apple Watch®, this service includes:

- **Journey Tracking** - This opt-in feature can automatically record your journey history including your route and mileage statistics. This information can be exported by email to use for expense reporting and can be imported to a spreadsheet.
- **Vehicle Status Check** - Check current fuel level and range, and status of door and window position and locks. See the last parked location of the vehicle and find your way back to it with on-foot directions.

OPTIONAL FEATURES

NAVIGATION PRO

Navigation Pro allows you to save your favourite places, use swipe and pinch to zoom gestures for simple map exploration and display a choice of either 2D or 3D crystal clear map graphics. Navigation Pro functionality is further enhanced by the Connect Pro Pack.

CONNECT PRO PACK

Connect Pro consists of InControl Apps, Remote Premium, a 4G Wi-Fi Hotspot, Pro Services and Connected Navigation. It's designed to enhance your in-car and out-of-car experience, ensuring you and your passengers enjoy the journey whilst remaining connected to the world.

INCONTROL APPS

Jaguar InControl Apps technology allows vehicle-optimised apps on your Android™ or Apple smartphone to be controlled through the vehicle's Touchscreen, including contacts, calendar and music player via a USB cable. You can also download third-party apps offering a range of services.

- **Spotify¹** – Access a library of more than 30 million songs with this seamlessly integrated app. Featuring all the same intuitive functionality as the Spotify smartphone app, you can search songs, stations and recommendations, create playlists and access your music in offline mode. Simply log in using your existing Spotify Free or Spotify Premium account.
- **Tile²** – Helps you find lost or misplaced items in seconds. Attach a tiny Bluetooth tracker Tile to your keys, wallet or bag. The easy-to-use Tile app can then help you find these items should they be misplaced. The app is accessible any time through your vehicle's Touchscreen, allowing you to make sure you have everything you need with you, before you set off on your journey.

REMOTE PREMIUM

Remote Premium provides the following enhancements to the Remote Essentials smartphone app:

- **Remote Lock/Unlock** – Lock or unlock your doors remotely with the click of a button. Simply press the 'lock' button on the Vehicle Security screen of the Remote smartphone app to single lock the doors, arm the alarm, fold in the wing mirrors³ and close the windows. Press the 'unlock' button to unfold the wing mirrors, turn on the dipped headlights and cause the hazard lights to flash twice.

- **Remote Climate** – Prepare your XF in advance by pre-heating or pre-cooling the cabin, so that you and your passengers are comfortable from the moment you step inside.
- **Beep/Flash** – This feature turns on your Jaguar's hazard lights, dipped headlights and sounds an audible alert to help you locate your vehicle in a crowded car park.

4G Wi-Fi

The 4G Wi-Fi Hotspot provides in-car access to the Internet, enabling up to eight wireless devices to be used simultaneously in the car. Passengers can connect through the vehicle's wireless network to surf, work, update social media and stay entertained throughout the journey.

PRO SERVICES

- **Real Time Traffic Information** – Uses live traffic data feeds to give you the most accurate picture of what the traffic is like on the way to your destination.
- **One-box Search** – Wherever you are, you can search the surrounding area for places of interest. The system can access expert destination information, travel tips and inspiration as well as online travel reviews of the local area.
- **Planning Routes and Door-to-Door Routing** – Before setting off, use the Route Planner app or online portal to search, save locations or set your destination. The app uses the Cloud to send your destination automatically to your vehicle's navigation screen. Once you've parked, the Route Planner app will guide you to your destination – a true door-to-door experience which includes public transport options.
- **Share ETA** – You can share your estimated time of arrival so your selected contact(s) will know exactly when you will arrive, as calculated by the navigation guidance system. If you're running late, Share ETA can then send automatic updates via text messages or email, without any further action from you.

Remote contains subscription services that can be extended after the initial term advised by your Jaguar Retailer. InControl features, options and their availability remain market dependent – check with your Jaguar Retailer for local market availability and full terms. Information and images displayed in relation to the InControl technology, including screens or sequences, are subject to software updates, version control and other system/visual changes depending on options selected. Mobile network connectivity cannot be guaranteed in all locations. InControl Apps and Remote App will need to be downloaded from the Apple/Google Play Store. All in-car features should be used by drivers only when safe for them to do so. Drivers must ensure they are in full control of the vehicle at all times.

Stay connected while on the move your new Jaguar XF will arrive with a SIM Card equipped with an Essential data plan of 500MB of data per month for the initial warranty period. You'll be better connected, receiving live traffic updates and more. Additional data can be purchased.

- **Satellite View** – When you want to get the context of your surroundings from overhead, simply switch to satellite view.
- **Commute Mode** – Allows the system to learn your commutes and automatically advises you of the expected journey time based on live and historical traffic movements without you having to input a destination. The system learns the routes you take for a given destination and then advises which of those is the quickest. The feature can be turned on and off dependent on driver preference.
- **Parking Service** – As you approach your destination, you can see where parking is available. Simply tap on your preferred car park and the navigation system updates to direct you to it.
- **Online Routing** – While you're on your way to a destination the system monitors live traffic conditions and takes into account typical traffic patterns for that time of day, keeping you on the optimum route.
- **Safety Cameras** – Alerts you to the location of accident black spots monitored by safety cameras.
- **Fuel Prices** – When you're going to fill up, the Fuel Price service not only finds filling stations along your route, it also enables you to compare fuel prices so you can keep your costs down.

OPTIONAL FEATURE

SECURE TRACKER⁴

Uses tracking technology to alert you to an attempted theft, and signals your vehicle's location to the relevant authorities, for a timely recovery.

¹Please check App Store and Google Play for availability.

²Bluetooth tracker tiles must be purchased separately. 2016 Tile Inc. and the Tile design are trademarks of Tile, Inc.

³When power fold mirrors are specified.

⁴Secure Tracker will require further subscription after the initial term as advised by your Jaguar Retailer.



AUDIO

A vehicle's cabin is the ideal place within which to experience your personal choice of music and Jaguar XF has the option of three different audio systems to bring your music to life:



SOUND SYSTEM

Excellent acoustic range through eight speakers.

MERIDIAN™ SOUND SYSTEM

Great definition, crystal clear highs and full, deep bass – delivered through the careful arrangement of 10 speakers and a dual channel subwoofer.

MERIDIAN SURROUND SOUND SYSTEM







All the fullness and clarity of a live performance delivered through an arrangement of 16 front, side and rear speakers and a dual channel subwoofer – seamlessly brought together using Trifield™ technology. Exclusive to Meridian, Trifield perfectly blends the centre and surround channels with left and right channels ensuring an optimum, consistent sound experience for each passenger.

DIGITAL AUDIO BROADCAST (DAB) RADIO

DAB radio technology offers improved sound quality, a wide choice of stations and live text information about the station, show and song you are listening to.

MERIDIAN

Formed in 1977 in Cambridgeshire, England, Jaguar’s audio partner Meridian has pioneered many firsts including active speakers and the world’s first digital surround sound processor. Meridian’s audio technology input has helped ensure that Jaguar XF is the most superb space within which to experience sound. Meridian Cabin Correction technology was utilised to analyse cabin shape, acoustics and resonance characteristics in order to help remove unwanted sounds. The advanced algorithm ensures that the rhythm, punch and timing of any piece of music are heard precisely how the artist intended, providing a consistently exceptional quality audio experience for all passengers in the vehicle.

	UNIQUE MERIDIAN TECHNOLOGY	SPEAKERS + SUBWOOFER	WATTS
SOUND SYSTEM	N/A	8	180
MERIDIAN™ SOUND SYSTEM	  	10+1	380
MERIDIAN™ SURROUND SOUND SYSTEM	   	16+1	825



DIGITAL SIGNAL PROCESSING

Brings all elements of the audio system together as one, for performance that would otherwise require significantly larger speakers.



MERIDIAN CABIN CORRECTION

The advanced algorithm of Meridian’s Cabin Correction tailors the sound experience to the precise acoustics of XF’s interior.



MERIDIAN DIGITAL DITHER SHAPING

To maintain the quality of musical recordings, they are converted into a common digital format. Meridian Digital Dither Shaping ensures that digital signal conversions are made smoothly and seamlessly, preserving the finest details of the audio performance. The result is authentic musical conversion, evoking the emotions of the original recording.



TRIFIELD

Exclusive to Meridian, Trifield blends the centre and surround channels seamlessly with left and right channels, delivering a consistent, concert-like experience for all occupants.

Meridian is a registered trademark of Meridian Audio Ltd.
Trifield and the “three fields” device is a trademark of Trifield Productions Ltd.
Features and their availability may differ by vehicle specification and market.

SAFETY AND EFFICIENCY DRIVER ASSISTANCE

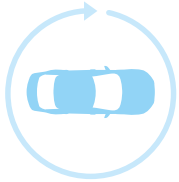

360° SURROUND CAMERA¹

Helping with various manoeuvres, from parking by a kerb to getting in and out of tight spaces and junctions, Surround Camera System gives you 360° exterior vision on the Touchscreen. To enhance this system further, new Forward Vehicle Guidance and Forward Traffic Detection are also available. Forming part of the 360° Surround Camera, Forward Vehicle Guidance provides the driver with an onscreen visualisation of the vehicle and parking distance. Forward Traffic Detection helps avoid potential collisions in situations where forward manoeuvres involve restricted views.



REAR CAMERA

Rear Camera provides improved visibility when reversing. This valuable parking aid also helps when hitching a trailer. Static lines representing the vehicle's outer perimeter and predicted path are superimposed on the rearward image, to make parking in tight spots as easy as possible.

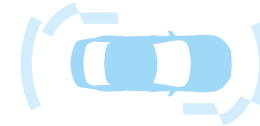

360° PARKING AID

360° Parking Aid uses ultrasonic sensors to the front, rear and sides of the vehicle to alert you to the proximity of objects when parking or exiting from a bay.



AUTONOMOUS EMERGENCY BRAKING

Should a potential collision be detected, XF gives an audible forward collision warning. Visual warnings follow. If the driver takes no action, the system applies the brakes to help reduce the severity of the possible impact.



PARK ASSIST

Park Assist makes parking in tight spaces easier than ever. XF can accurately steer itself during both parallel and bay parking manoeuvres - the driver only has to control the brakes and accelerator. An exit-assist function can help guide XF while leaving a parallel space.



TRAFFIC SIGN RECOGNITION AND ADAPTIVE SPEED LIMITER

Traffic Sign Recognition technology detects speed limits, including variable limits, and no overtaking signs via the forward-facing cameras, then displays them to the driver. The Adaptive Speed Limiter uses detected traffic sign information to help keep XF within the appropriate speed limit. Where no traffic sign is detected, the Adaptive Speed Limiter can also use the map data from the navigation guidance system.

¹Requires power fold mirrors.

²Only available on automatic transmission.

Please refer to pages 62 to 69 for fitment requirements and availability.



BLIND SPOT ASSIST¹

Blind Spot Assist can help you prevent collisions. If your vehicle detects another car in your blind spot when you begin to change lanes, a small warning light illuminates in the corresponding wing mirror and a steering torque encourages you to guide your vehicle away from the approaching vehicle.

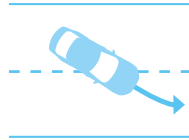

LANE DEPARTURE WARNING

Lane Departure Warning can help make long journeys much safer. The system senses when your vehicle is unintentionally drifting out of your lane, and notifies you with a visual alert and a gentle vibration of the steering wheel.



LANE KEEP ASSIST AND DRIVER CONDITION MONITOR

Building on Lane Departure Warning, Lane Keep Assist senses unintentional lane drift and helps steer XF back into its lane. Driver Condition Monitor detects lapses in concentration due to tiredness by monitoring driver inputs and suggests taking a break via an audible alert and a visual notification in the instrument cluster.



REVERSE TRAFFIC DETECTION¹

Reverse Traffic Detection is particularly useful when reversing out of a parking bay, the system warns you of vehicles, pedestrians or other hazards, approaching from either side of your vehicle. It will alert you with both audio and visual warnings so you know what's behind you even when the view is obstructed.



PEDESTRIAN CONTACT SENSING

Help protect the people outside your car as well as those inside. If the car makes contact with a pedestrian, our industry leading Pedestrian Contact Sensing system is designed to automatically raise the bonnet to help cushion a potential impact.

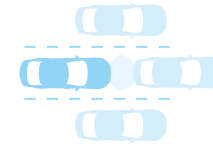

ADAPTIVE CRUISE CONTROL WITH QUEUE ASSIST²

Adaptive Cruise Control uses radar technology to automatically adjust your speed to maintain a safe distance from the vehicle ahead. XF resumes its pre-set speed as soon as the road in front is clear. Should the car in front stop completely, the Queue Assist function brings XF to a smooth halt. Once the traffic moves off, touch the accelerator and XF will follow the car in front again.



**300
SPORT**

XF 300 SPORT EDITION

Racing heritage flares throughout XF 300 SPORT. Exclusive styling enhances its exterior, suggesting it is something special. The theme continues inside, with subtle yet exciting detailing accentuating all aspects of the interior. Beneath the aluminium bonnet lies a choice between a Turbocharged Ingenium Petrol engine or a V6 Twin Turbocharged Diesel, each delivering an impressive 300PS.

XF 300 SPORT FEATURES

• 2.0 litre 4-cylinder Turbocharged petrol • 3.0 litre V6 Twin Turbocharged diesel

Exterior:

- A flash of Yellow on the brake calipers • Striking Yellow badging on the bootlid/tailgate and on the mesh grille
- Purposeful looking fender vents in Dark Satin Grey match the exclusive 19" wheels with Dark Satin Grey Metallic finish
- Available in Yulong White, Indus Silver and Santorini Black

Interior:

- Soft grain leather steering wheel • Gearshift paddles, machined from billet aluminium • Sports pedals and 300 SPORT branded treadplates • Yellow twin-needle contrast stitching throughout.



PERSONALISATION XF - YOUR CHOICE

 Configure your vehicle at jaguar.co.uk



CHOOSE YOUR ENGINE

Page 56

Select one of XF's powerful, efficient petrol or diesel engines to suit your driving style.

CHOOSE YOUR MODEL & OPTIONS

Page 60

Compare the wealth of standard features and options on XF models.

CHOOSE YOUR COLOUR

Page 70

Express your individuality with one of XF's stunning exterior colours.

CHOOSE YOUR WHEELS

Page 72

Add the personal finishing touch to your new XF, and complement its stunning style, with a set of beautifully designed alloy wheels.

CHOOSE YOUR INTERIOR

Page 74

There's a wide selection of premium materials, leathers, veneers and finishes for every personal taste.

CHOOSE YOUR JAGUAR GEAR - ACCESSORIES

Page 88

Really make it yours by adding style, practicality and versatility with official XF Gear Accessories from your local Jaguar Retailer.

1 CHOOSE YOUR ENGINE

 Configure your vehicle at jaguar.co.uk

> DIESEL ENGINES

2.0 LITRE

4-CYLINDER TURBOCHARGED E-PERFORMANCE

XF SALOON	XF SPORTBRAKE
MAXIMUM POWER 163PS	MAXIMUM POWER 163PS
MAXIMUM TORQUE 380Nm	MAXIMUM TORQUE 380Nm
ACCELERATION 0-60 mph Manual RWD 9.3 seconds Automatic RWD 8.6 seconds	ACCELERATION 0-60 mph Manual RWD 9.5 seconds Automatic RWD 8.8 seconds
TOP SPEED Manual RWD/Automatic RWD 132 mph	TOP SPEED Manual RWD/Automatic RWD 132 mph
PRESTIGE, PORTFOLIO, R-SPORT	PRESTIGE, PORTFOLIO, R-SPORT

2.0 LITRE

4-CYLINDER TURBOCHARGED

XF SALOON	XF SPORTBRAKE
MAXIMUM POWER 180PS	MAXIMUM POWER 180PS
MAXIMUM TORQUE 430Nm	MAXIMUM TORQUE 430Nm
ACCELERATION 0-60 mph Manual RWD 8.7 seconds Automatic RWD 7.9 seconds Automatic AWD 8.0 seconds	ACCELERATION 0-60 mph Automatic RWD 8.0 seconds Automatic AWD 8.1 seconds
TOP SPEED Manual RWD/Automatic RWD/Automatic AWD 136 mph	TOP SPEED Automatic RWD/Automatic AWD 136 mph
PRESTIGE, PORTFOLIO, R-SPORT	PRESTIGE, PORTFOLIO, R-SPORT

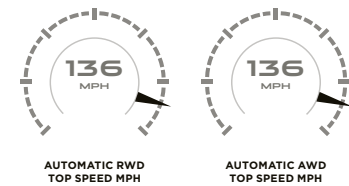
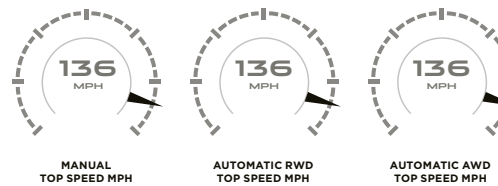
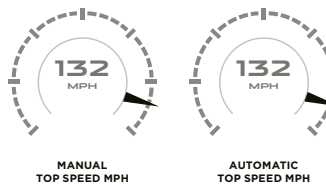
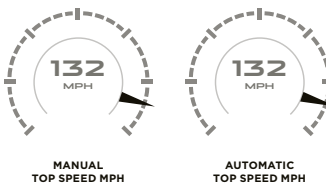
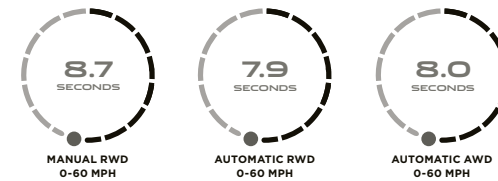
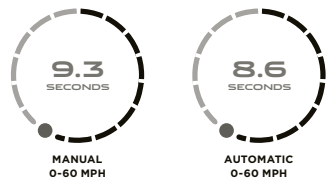

Please refer to Technical Specification pages 96 to 99 for full fuel consumption figures.

All figures are manufacturer's targets and subject to final confirmation ahead of production. Note that CO₂ and fuel economy figures can vary according to wheel fitment, and the lowest figures may not be achievable with the standard wheels.

2.0 LITRE

4-CYLINDER TWIN TURBOCHARGED

XF SALOON

MAXIMUM POWER 240PS

MAXIMUM TORQUE 500Nm

ACCELERATION 0-60 mph
Automatic AWD 6.5 seconds

TOP SPEED
Automatic AWD 153 mph

PRESTIGE, PORTFOLIO, R-SPORT

XF SPORTBRAKE

MAXIMUM POWER 240PS

MAXIMUM TORQUE 500Nm

ACCELERATION 0-60 mph
Automatic AWD 6.7 seconds

TOP SPEED
Automatic AWD 150 mph

PRESTIGE, PORTFOLIO, R-SPORT



AUTOMATIC AWD
0-60 MPH



AUTOMATIC AWD
0-60 MPH

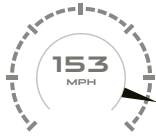

AUTOMATIC AWD
TOP SPEED MPH

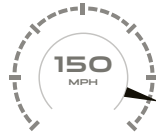

AUTOMATIC AWD
TOP SPEED MPH

3.0 LITRE V6

6-CYLINDER TWIN TURBOCHARGED

XF SALOON

MAXIMUM POWER 300PS

MAXIMUM TORQUE 700Nm

ACCELERATION 0-60 mph
Automatic RWD 6.0 seconds

TOP SPEED
Automatic RWD 155 mph

PORTFOLIO, S

XF SPORTBRAKE

MAXIMUM POWER 300PS

MAXIMUM TORQUE 700Nm

ACCELERATION 0-60 mph
Automatic RWD 6.1 seconds

TOP SPEED
Automatic RWD 155 mph

PORTFOLIO, S



AUTOMATIC RWD
0-60 MPH



AUTOMATIC RWD
0-60 MPH



AUTOMATIC RWD
TOP SPEED MPH

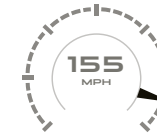

AUTOMATIC RWD
TOP SPEED MPH

1 CHOOSE YOUR ENGINE

 Configure your vehicle at jaguar.co.uk

> PETROL ENGINES

2.0 LITRE

4-CYLINDER TURBOCHARGED

XF SALOON

MAXIMUM POWER 250PS

MAXIMUM TORQUE 365Nm

ACCELERATION 0-60 mph
Automatic RWD 6.4 seconds

TOP SPEED Automatic RWD 152 mph

PRESTIGE, PORTFOLIO, R-SPORT

XF SPORTBRAKE

MAXIMUM POWER 250PS

MAXIMUM TORQUE 365Nm

ACCELERATION 0-60 mph
Automatic RWD 6.5 seconds

TOP SPEED Automatic RWD 150 mph

PRESTIGE, PORTFOLIO, R-SPORT



AUTOMATIC RWD
0-60 MPH



AUTOMATIC RWD
TOP SPEED MPH



AUTOMATIC RWD
0-60 MPH



AUTOMATIC RWD
TOP SPEED MPH

2.0 LITRE

4-CYLINDER TURBOCHARGED

XF SALOON

MAXIMUM POWER 300PS

MAXIMUM TORQUE 400Nm

ACCELERATION 0-60 mph
Automatic AWD 5.6 seconds

TOP SPEED Automatic AWD 155 mph

PRESTIGE, PORTFOLIO, R-SPORT

XF SPORTBRAKE

MAXIMUM POWER 300PS

MAXIMUM TORQUE 400Nm

ACCELERATION 0-60 mph
Automatic AWD 5.7 seconds

TOP SPEED Automatic AWD 155 mph

PRESTIGE, PORTFOLIO, R-SPORT



AUTOMATIC AWD
0-60 MPH

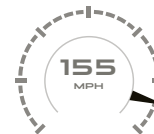

AUTOMATIC AWD
TOP SPEED MPH



AUTOMATIC AWD
0-60 MPH



AUTOMATIC AWD
TOP SPEED MPH

Please refer to Technical Specification pages 96 to 99 for full fuel consumption figures.

All figures are manufacturer's targets and subject to final confirmation ahead of production. Note that CO₂ and fuel economy figures can vary according to wheel fitment, and the lowest figures may not be achievable with the standard wheels.

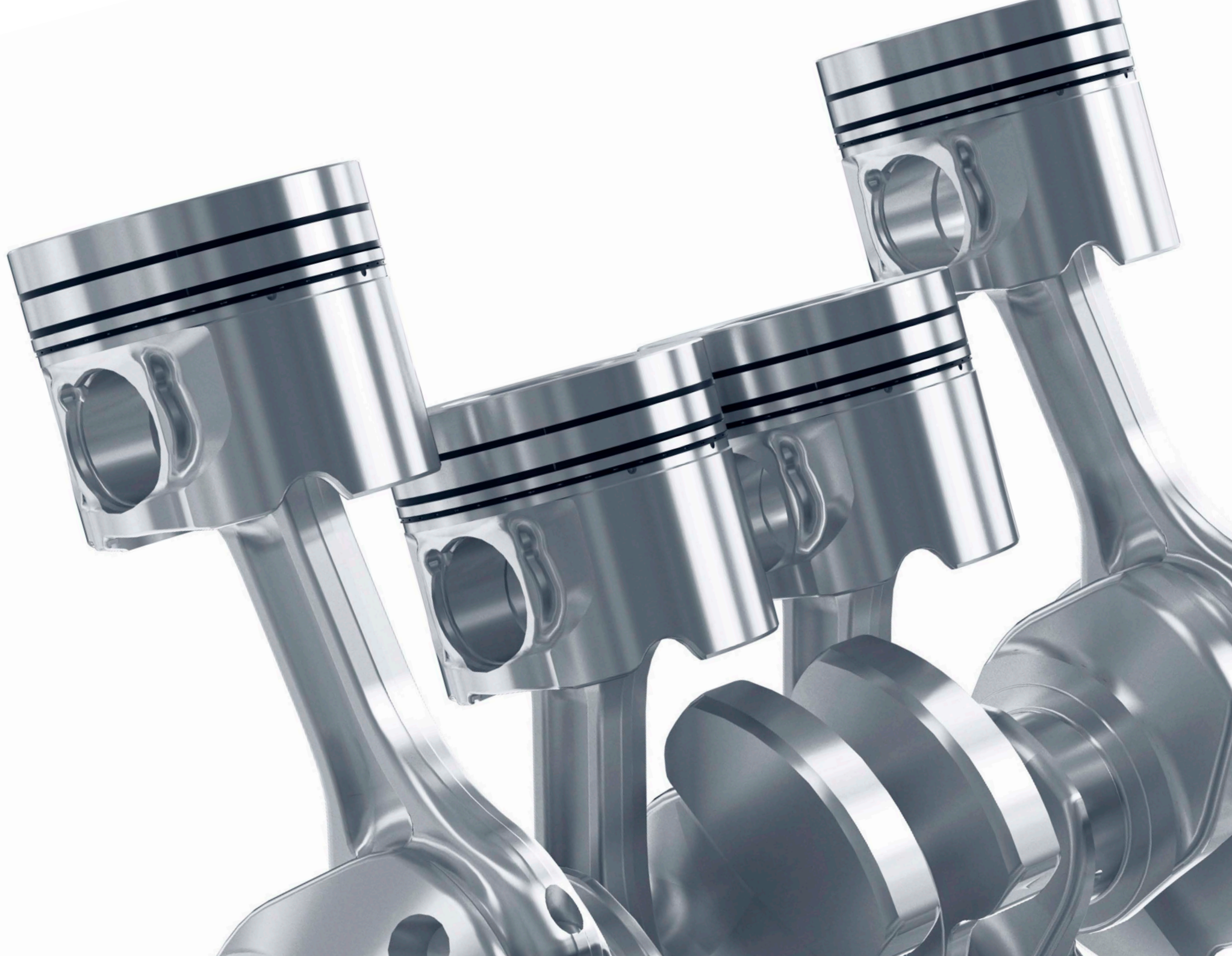

2 CHOOSE YOUR MODEL

 Configure your vehicle at jaguar.co.uk

LUXURY



PRESTIGE

KEY FEATURES

- 17" alloy wheels
- Bi-functional Xenon headlights with LED 'J' blade Daytime Running Lights and power wash
- Perforated grained heated leather seats (8-way adjustable)
- Premium carpet mats
- Gloss Black trim finisher
- Suedecloth headlining
- Frameless auto-dimming interior rear view mirror
- Ambient Interior Lighting
- 10" Touch Pro Screen with Navigation Pro
- InControl Apps, Remote Premium, Protect, Wi-Fi
- Sound System (180W)
- Illuminated metal treadplates with Jaguar script

XF SPORTBRAKE KEY FEATURES (IN ADDITION TO SALOON)

- Integrated roof rails
- Integrated roof spoiler
- Rear self-levelling air suspension
- Automatic loadspace cover
- 40:20:40 split fold rear seats
- Powered tailgate
- Stainless steel loadspace scuff plate

*Boot mounted spoiler only available on XF Saloon.

Images feature optional equipment. Please note that standard features may be replaced when selecting alternative trim levels. Standard features may also vary depending on engine variant and transmission. Please refer to Specification and Price Guide or jaguar.co.uk



PORTFOLIO

KEY FEATURES (IN ADDITION TO PRESTIGE)

- 18" alloy wheels (17" alloy wheels on 2.0 litre 4-cylinder 163PS Diesel engine)
- Perforated Windsor leather seats (10-way adjustable)
- Windsor leather instrument panel finisher
- 40:20:40 split fold rear seats
- Gloss Figured Ebony veneer
- Keyless Entry
- Heated windscreen
- Auto-dimming, power fold, heated door mirrors with approach lights
- Rear Camera

XF SPORTBRAKE KEY FEATURES (IN ADDITION TO SALOON)

- Integrated roof rails
- Integrated roof spoiler
- Rear self-levelling air suspension
- Automatic loadspace cover
- Powered tailgate
- Stainless steel loadspace scuff plate

> SPORT



R-SPORT

KEY FEATURES (IN ADDITION TO PRESTIGE)

18" alloy wheels (17" alloy wheels on 2.0 litre 4-cylinder 163PS Diesel engine)
R-Sport body kit including sports front bumper, side sills and boot mounted spoiler*
Sports suspension (only available on Ingenium 2.0 litre Petrol 250PS RWD engine and Ingenium Diesel 180PS and 240PS RWD engines)
Perforated grained leather sport seats with contrast stitching (8-way adjustable)
Multi-function steering wheel with R-Sport branding
Gloss Black side window surround
Dark Morse Code Aluminium instrument panel finisher
Front Parking Aid

XF SPORTBRAKE KEY FEATURES (IN ADDITION TO SALOON)

Gloss Black roof rails
Integrated roof spoiler
Rear self-levelling air suspension
Automatic loadspace cover
40:20:40 split fold rear seats
Powered tailgate
Stainless steel loadspace scuff plate



S

KEY FEATURES (IN ADDITION TO R-SPORT)

19" alloy wheels
S body kit including sports front bumper, Gloss Black side sills, rear valance and boot mounted spoiler*
Red brake calipers
Sports grained leather S embossed seats
Grey Figured Ebony veneer
Dark Hex Aluminium instrument panel finisher
Multi-function steering wheel with S branding
40:20:40 split fold rear seats
Adaptive Dynamics

XF SPORTBRAKE KEY FEATURES (IN ADDITION TO SALOON)

Gloss Black roof rails
Integrated roof spoiler
Rear self-levelling air suspension
Automatic loadspace cover
Powered tailgate
Stainless steel loadspace scuff plate

2 CHOOSE YOUR OPTIONS

 Configure your vehicle at jaguar.co.uk

KEY STANDARD FEATURES

	PRESTIGE	PORTFOLIO	R-SPORT	S	DESCRIPTION
Intelligent Stop/Start system	●	●	●	●	Refer to page 22
Hill Launch Assist	●	●	●	●	Prevents your XF from rolling backwards when pulling away on an incline, helping you to make the perfect hill start every time
JaguarDrive Control with Eco, Dynamic, Normal and Rain/Ice/Snow Mode	●	●	●	●	
Electric Power Assisted Steering (EPAS)	●	●	●	●	Refer to page 32
Electric Park Brake with drive away release	●	●	●	●	Automatically releases the parking brake without the need for driver input as you press the accelerator to drive away
Emergency Brake Assist	●	●	●	●	Increases braking pressure in an emergency situation
Autonomous Emergency Braking	●	●	●	●	Refer to page 50
Hazard lights under heavy braking	●	●	●	●	
Airbags	●	●	●	●	Driver and front passenger with seat occupant detector for passenger, front side and full length side window curtain
Torque Vectoring	●	●	●	●	Refer to page 39
Dynamic Stability Control and Traction Control	●	●	●	●	Refer to page 41
Cruise Control with Speed Limiter	●	●	●	●	
Lane Departure Warning	●	●	●	●	Refer to page 51
Trailer Stability Assist	●	●	●	●	Intervenes when the system detects sway or potentially dangerous movement to bring the trailer back under control
Electric front and rear windows with one-touch open/close and anti-trap	●	●	●	●	
Rain sensing windscreen wipers	●	●	●	●	
Body-coloured, heated, electric exterior door mirror	●	●	●	●	
Two-zone Climate Control	●	●	●	●	
10" Touch Pro Screen	●	●	●	●	Refer to page 43
USB, Auxiliary socket and iPod* connectivity	●	●	●	●	Refer to page 44-47
Bluetooth* telephone connectivity	●	●	●	●	Refer to page 44-47
Bluetooth* streaming	●	●	●	●	Refer to page 44-47
Jaguar Smart Key System – Keyless Start	●	●	●	●	
LED tail lights	●	●	●	●	
ISOFIX anchor points for rear child seats	●	●	●	●	
Heated rear windscreen	●	●	●	●	
Power operated child locks	●	●	●	●	
Tailgate spoiler (not available on XF Saloon)	●	●	●	●	
Rear self-levelling air suspension (not available on XF Saloon)	●	●	●	●	Refer to page 8

● Standard ○ Option — Not available

Please consult your local Jaguar Retailer for details.

For a complete list of optional features and packs refer to the XF Specification and Price Guide or configure your vehicle at jaguar.co.uk

KEY OPTIONAL FEATURES

		PRESTIGE	PORTFOLIO	R-SPORT	S			
DYNAMIC FEATURES		CODE				DESCRIPTION		
6-speed Manual Transmission with Optimal Shift Indicator (only available on 2.0 litre 4-cylinder Diesel engines)			●	●	●	—		
8-speed Automatic Transmission with Jaguar Sequential Shift, gearshift paddles and All Surface Progress Control			○	○	○	●		
Sports suspension upgrade (only available on 2.0 litre 4-cylinder Petrol RWD engines and 2.0 litre 4-cylinder Diesel 180PS. Only available on XF Saloon)			—	—	●	—	Adds sports springs and dampers	
Adaptive Dynamics (not available on 2.0 litre 4-cylinder 163PS Diesel engine. Includes Configurable Dynamics on automatic transmission)	027CW	○	○	○	○	●		Refer to page 32
Configurable Dynamics (not available with 163PS Diesel engine or manual transmission)	184AB	○	○	○	○	●		Refer to page 32
Adaptive Cruise Control with Queue Assist (requires automatic transmission)	065AG	○	○	○	○	○		Refer to page 51
Adaptive Surface Response (AdSR) (replaces Rain Ice Snow Mode, requires AWD, automatic transmission and Adaptive Dynamics)	088IG	○	○	○	○	—		Refer to page 34
350mm brakes (option only on 2.0 litre 4-cylinder 180PS and 240PS Diesel engines and 2.0 litre 4-cylinder 250PS Petrol engine. Standard on 300PS engines)	020DA	○	○	○	○	●		

EXTERIOR FEATURES AND FINISHERS

EXTERIOR FEATURES AND TRIM							
Electric tilt/slide sunroof (only available on XF Saloon)	041CZ	○	○	○	○		
Fixed panoramic roof (only available on XF Sportbrake)	041CX	○	○	○	○		Refer to page 21
Full length Gloss Black roof rails (only available on XF Sportbrake)	060BB	—	—	●	●		
Full length Silver roof rails (only available on XF Sportbrake)	060BA	●	●	○	—		Finish of roof rails to match side window surround
Powered tailgate/boot lid	070AV	○	○	○	○		Standard on XF Sportbrake
Powered gesture tailgate/boot lid (requires Keyless Entry)	070BA	○	○	○	○		Refer to page 8
Soft door close (requires Keyless Entry)	173AB	○	○	○	○		Automatically ensures that doors close softly, securely and with minimum exertion
Chrome radiator grille with Chrome surround	064FR	—	●	—	—		
Chrome side window surround	081DA	●	●	○	○		
Gloss Black side window surround	081DB	—	—	●	●		
R-Sport body kit		—	—	●	—		Includes R-Sport front bumper, body-coloured side sills and boot lid mounted spoiler (XF Saloon only), Satin Chrome side power vents with R-Sport badge
S body kit		—	—	—	●		Includes S front bumper, Gloss Black side sills and rear valance, body-coloured boot lid mounted spoiler (XF Saloon only), Satin Chrome side power vents
Engine de-badge (not available on 2.0 litre 4-cylinder 163PS Diesel engine)	057EV	○	○	○	—		Removes engine badging

2 CHOOSE YOUR OPTIONS

 Configure your vehicle at jaguar.co.uk

EXTERIOR FEATURES AND FINISHERS CONTINUED

		PRESTIGE	PORTFOLIO	R-SPORT	S	
GLASS AND EXTERIOR MIRRORS						
Solar attenuating windscreen (front screen only)	047EB	<input type="radio"/>	<input type="radio"/>	<input type="radio"/>	<input type="radio"/>	This windscreen reflects infrared rays, keeping XF's interior cooler
Heated front windscreen with heated washer jets	040AK	<input type="radio"/>	<input checked="" type="radio"/>	<input type="radio"/>	<input checked="" type="radio"/>	
Privacy glass	047DB	<input type="radio"/>	<input type="radio"/>	<input type="radio"/>	<input type="radio"/>	
Auto-dimming heated door mirrors with power fold and approach lights	030NK	<input type="radio"/>	<input checked="" type="radio"/>	<input type="radio"/>	<input checked="" type="radio"/>	
HEADLIGHTS AND LIGHTING						
Bi-function Xenon headlights with LED 'J' blade Daytime Running Lights, automatic levelling and headlight power wash	064CW	<input checked="" type="radio"/>	<input checked="" type="radio"/>	<input checked="" type="radio"/>	<input checked="" type="radio"/>	
LED headlights with LED 'J' blade Daytime Running Lights, adaptive lighting, turning light, Automatic High Beam Assist and headlight power wash	064GJ	<input type="radio"/>	<input type="radio"/>	<input type="radio"/>	<input type="radio"/>	Refer to page 10
TOWING						
Detachable tow bar ¹	028EM	<input type="radio"/>	<input type="radio"/>	<input type="radio"/>	<input type="radio"/>	Tow bar is not available with 20" wheels if space saver spare is fitted on XF Sportbrake
Electrically deployable tow bar ^{1 2}	028EJ	<input type="radio"/>	<input type="radio"/>	<input type="radio"/>	<input type="radio"/>	Tow bar is not available with 20" wheels if space saver spare is fitted on XF Sportbrake
EXTERIOR COLOURS						
Solid paint		<input checked="" type="radio"/>	<input checked="" type="radio"/>	<input checked="" type="radio"/>	<input checked="" type="radio"/>	Refer to page 70
Metallic paint		<input type="radio"/>	<input type="radio"/>	<input type="radio"/>	<input type="radio"/>	Refer to pages 70-71
Premium paint		<input type="radio"/>	<input type="radio"/>	<input type="radio"/>	<input type="radio"/>	Refer to page 71
WHEELS						
Jaguar Tyre Repair System		<input checked="" type="radio"/>	<input checked="" type="radio"/>	<input checked="" type="radio"/>	<input checked="" type="radio"/>	
Space saver spare wheel (18")	029VT	<input type="radio"/>	<input type="radio"/>	<input type="radio"/>	<input type="radio"/>	Not available with 20" wheels if tow bar is fitted on XF Sportbrake
Tyre Pressure Monitoring System		<input checked="" type="radio"/>	<input checked="" type="radio"/>	<input checked="" type="radio"/>	<input checked="" type="radio"/>	

● Standard ○ Option — Not available ■ Part of Pack

¹Not available on 2.0 litre 4-cylinder 163PS Diesel engine on XF Saloon with manual transmission.

²Not available on 2.0 litre 4-cylinder 163PS Diesel engine on XF Sportbrake. Reduced towing limit on 2.0 litre 4-cylinder 163PS Diesel engine on XF Saloon.

³Only available in sports grained leather (033YF).

Please consult your local Jaguar Retailer for details.

For a complete list of optional features and packs refer to the XF Specification and Price Guide or configure your vehicle at jaguar.co.uk

SEATING AND VENEERS

		PRESTIGE	PORTFOLIO	R-SPORT	S	
SEATING		CODE				DESCRIPTION
Heated front seats	033BV	●	●	●	●	
Heated front and rear seats	033EQ	○	○	○	○	
Climate front seats (requires leather seats and 4-way electric lumbar adjust)	033GP	○	○	○	○	Heated and cooled front seats
Climate front seats and heated rear seats (requires leather seats and 4-way electric lumbar adjust)	033GQ	○	○	○	○	Heated and cooled front and rear seats
8-way manual front seat with electric recline		●	—	●	—	
10-way electric front seats with manual headrest height	033UK	○	○	●	●	
4-way electric lumbar adjust (not available with 8-way seats)	033JT	○	●	○	●	
Driver memory		■	■	■	■	Adjusts driver seat, mirrors and steering column. Only available as part of Memory Pack without power fold mirrors and Memory Pack with power fold mirrors
18-way electric front sports seats		—	—	■ ³	■	With manual headrest height, 4-way electric lumbar adjust and passenger and driver memory. Only available as part of Premium Seat Upgrade with Memory Pack
20-way electric front luxury seats		—	■	—	—	With manual winged headrest height, 4-way electric lumbar adjust and passenger and driver memory. Only available as part of Premium Seat Upgrade with Memory Pack
Sports grained leather seats	033YF	—	—	●	●	
40:20:40 split fold rear seat with armrest (standard on all XF Sportbrake models)	033LP	○	●	○	●	

VENEERS

Refer to pages 86-87 for full range of veneers

HEADLINING AND INTERIOR FEATURES

HEADLINING					
Light Oyster headlining	032FE	●	●	○	○
Ebony headlining	032CU	○	○	●	●
Suedecloth headlining	088HE	●	●	●	●
Morzine headlining	088HH	○	○	○	○

2 CHOOSE YOUR OPTIONS

 Configure your vehicle at jaguar.co.uk

HEADLINING AND INTERIOR FEATURES CONTINUED

INTERIOR FEATURES	CODE	PRESTIGE	PORTFOLIO	R-SPORT	S	DESCRIPTION
Illuminated metal treadplates with Jaguar script	048BD	●	●	●	●	
Metal treadplates with R-SPORT branding	048BN	—	—	○	—	
Metal treadplates with S branding	048BP	—	—	—	○	
Premium carpet mats	079BO	●	●	●	●	
Bright metal pedals	051AJ	●	●	●	●	
Soft grain leather sport steering wheel		●	●	—	—	
R-Sport branded soft grain leather steering wheel		—	—	●	—	
S branded soft grain leather steering wheel		—	—	—	●	
Heated steering wheel (requires heated front seats)	032DV	○	○	○	○	
Electrically adjustable steering column	049AP	○	○	○	○	
Cabin pre-conditioning with remote	043BH	○	○	○	○	
Four-zone Climate Control with two additional power sockets (requires air quality sensor and lockable cooled glove box)*	022BC	○	○	○	○	Refer to page 17
Air quality sensor and lockable cooled glove box	022FA, 030DH	○	○	○	○	
Cabin Air Ionisation (only available on XF Sportbrake)	022GB	○	○	○	○	Refer to page 15
Manual rear side window sunblinds	112RC	○	○	○	○	
Electric rear window sunblind (not available on XF Sportbrake)	019CA	○	○	○	○	
Powered gesture roof blind (only available on XF Sportbrake. Requires fixed panoramic roof. Not available if Dual View is fitted. Removes sunglasses holder if fitted)	188FB	○	○	○	○	Refer to page 21
Ambient Interior lighting	064FB	●	●	●	●	
Configurable Ambient Interior Lighting with (10 colours)	064FC	○	○	○	○	Refer to page 17
Smoker's Pack	094AA	○	○	○	○	Includes single front ashtray, single cigar lighter and two single ashtray holders in rear door bins
Two additional power sockets	054AK	○	○	○	○	Additional 12V power socket in rear centre console and boot
Loadspace storage rails (only available on XF Sportbrake)	135AH	●	●	●	●	Refer to page 21

● Standard ○ Option — Not available

*Not available on 2.0 litre 4-cylinder 163PS Diesel engine.

Please consult your local Jaguar Retailer for details.

For a complete list of optional features and packs refer to the XF Specification and Price Guide or configure your vehicle at jaguar.co.uk

SAFETY AND SECURITY

		PRESTIGE	PORTFOLIO	R-SPORT	S	
SAFETY AND SECURITY	CODE					DESCRIPTION
Front Parking Aid	086EG	○	●	●	●	
Rear Parking Aid	086EH	●	●	●	●	
Rear Camera	086FA	○	●	○	○	Refer to page 50
360° Surround Camera (requires power fold mirrors and Rear Parking Aid)	086GC	○	○	○	○	Refer to page 50
Park Assist (requires Front Parking Aid)	086HA	○	○	○	○	Refer to page 50
360° Parking Aid (requires Front Parking Aid)	036MB	○	○	○	○	Refer to page 50
Garage Door Opener (HomeLink®)	025CT	○	○	○	○	
Lane Keep Assist and Driver Condition Monitor	086BD	○	○	○	○	Refer to page 51
Blind Spot Monitor and Reverse Traffic Detection (requires power fold mirrors)	086GF	○	○	○	○	Refer to page 51
Blind Spot Assist and Reverse Traffic Detection (requires power fold mirrors)	086GG	○	○	○	○	Refer to page 51
Traffic Sign Recognition and Adaptive Speed Limiter	086DC	●	●	●	●	Refer to page 50
Keyless Entry	066AC	○	●	○	●	
Activity Key (only available with XF Sportbrake)	066CA	○	○	○	○	Refer to page 19

2 CHOOSE YOUR OPTIONS

 Configure your vehicle at jaguar.co.uk

INCONTROL INFOTAINMENT AND CONNECTIVITY

INCONTROL INFOTAINMENT AND CONNECTIVITY	CODE	PRESTIGE	PORTFOLIO	R-SPORT	S	DESCRIPTION
10" Touch Pro		●	●	●	●	Refer to page 43
Analogue Dials with Central TFT Display		●	●	●	●	
Interactive Driver Display	038ID	○	○	○	○	
Jaguar Sound System		●	—	●	—	Refer to page 48-49
Meridian™ Sound System	025LM	○	●	○	●	Refer to page 48-49
Meridian™ Surround Sound System	025LN	○	○	○	○	Refer to page 48-49
Touch Pro Navigation Pack with 12.3" high-definition Interactive Driver Display, CD/DVD player and Meridian™ Sound System	017EG	○	○	○	○	Refer to page 43-47
Touch Pro Navigation Pack with 12.3" high-definition Interactive Driver Display, CD/DVD player and Meridian™ Surround Sound System	017EI	○	○	○	○	Refer to page 43-47
10" Touch Pro Dual View Screen (requires CD/DVD player and Meridian™ Sound System)	087AS	○	○	○	○	
Digital TV (requires CD/DVD player)	129AA	○	○	○	○	
Connect Pro Pack (Remote Premium, InControl Apps and Pro Services and Wi-Fi Hotspot)	011CB	●	●	●	●	Refer to page 46-47
Navigation Pro	087AU	●	●	●	●	Refer to page 46-47
CD/DVD player	025AM	○	○	○	○	
Digital Audio Broadcast (DAB) radio	025JB	●	●	●	●	
Protect		●	●	●	●	Includes SOS Emergency Call, Jaguar Optimised Assistance and Remote Essentials smartphone app. Refer to page 45
Secure Tracker	011AE	○	○	○	○	Stolen Vehicle Tracking via your smartphone app. Refer to page 47
Head-up Display with solar attenuating windscreen	017FG	○	○	○	○	Refer to page 43

● Standard ○ Option — Not available

*Not available on 2.0 litre 4-cylinder 163PS Diesel engine.

Please consult your local Jaguar Retailer for details.

For a complete list of optional features and packs refer to the XF Specification and Price Guide or configure your vehicle at jaguar.co.uk

OPTION PACKS

		PRESTIGE	PORTFOLIO	R-SPORT	S	
	CODE					DESCRIPTION
Cold Climate Pack	017CA	○	○	○	○	Consists of heated front windscreen, heated washer jets, heated steering wheel and heated front and rear seats
Power Convenience Pack	017DY	○	○	○	○	Consists of Keyless Entry, powered gesture boot lid and two additional power sockets
Parking Pack	017CO	○	—	—	—	Consists of Front and Rear Parking Aids and Rear Camera
Advanced Park Assist Pack	017CP	○	—	○	—	Consists of Parking Pack features plus 360° Parking Aid and Park Assist. Refer to page 50
Advanced Park Assist Pack with Surround Camera System	017CQ	○	○	○	○	Consists of Advanced Parking Assist Pack features plus 360° Camera System
Active Safety Pack	017DZ	○	○	○	○	Consists of Adaptive Cruise Control with Queue Assist (only available with automatic transmission), Lane Keep Assist and Driver Condition Monitor, Blind Spot Monitor and Reverse Traffic Detection (requires power fold mirrors and Rear Parking Aid)
Black Pack	032EI	—	—	○	—	Consists of Gloss Black radiator grille and surround, side power vents, boot lid finisher and body kit blades
Memory Pack with power fold mirrors	017CT	○	○	○	○	Consists of auto-dimming, power fold, heated door mirrors with memory and approach lights, auto-dimming rear view mirror, electrically adjustable steering column, driver seat memory and 10-way electric front seats
Premium Seat Upgrade with Memory Pack	017GU	—	○	○	○	Consists of auto-dimming, power fold, heated door mirrors with memory and approach lights, auto-dimming rear view mirror, electrically adjustable steering column, driver and passenger seat memory, 18-way electric front sport seats or 20-way electric front luxury seats
Rear Comfort Pack*	017FJ	○	○	○	○	Consists of heated front and rear seats, Four-zone Climate Control, manual rear side window sunblinds, lockable cooled glove box, air quality sensing and electric rear window sunblind (Saloon only)
Sportbrake Convenience Pack (only available on XF Sportbrake)	017GL	○	○	○	○	Consists of powered gesture boot lid, Keyless Entry, Activity Key and loadspace partition net

3 CHOOSE YOUR COLOUR

 Configure your vehicle at jaguar.co.uk

SOLID

Fuji White



Narvik Black

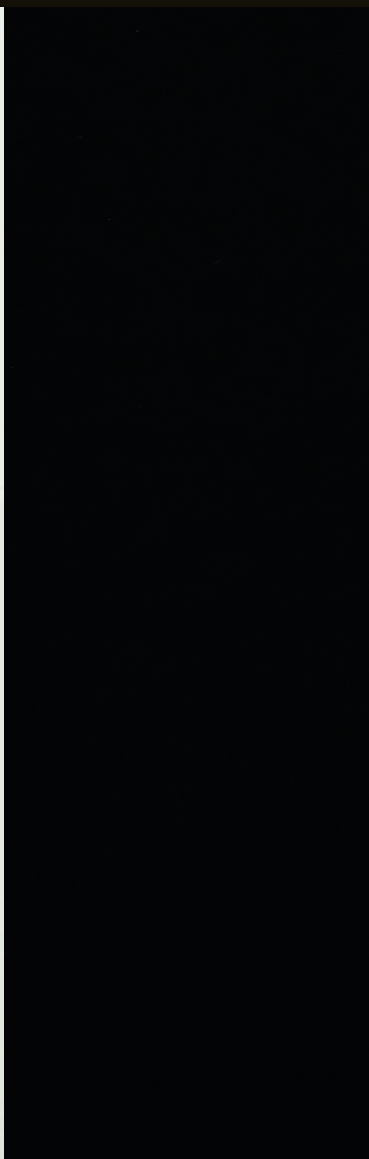

METALLIC

Yulong White

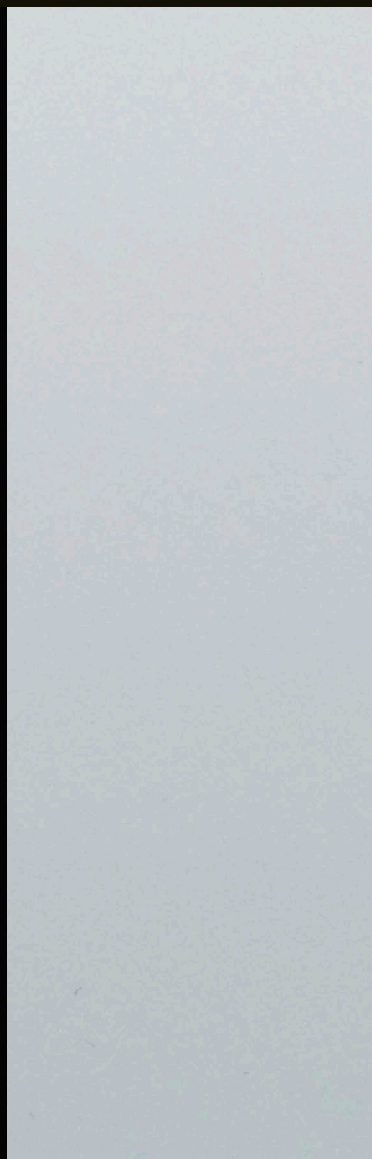

Santorini Black



Indus Silver



Corris Grey



Loire Blue



Caesium Blue



Firenze Red

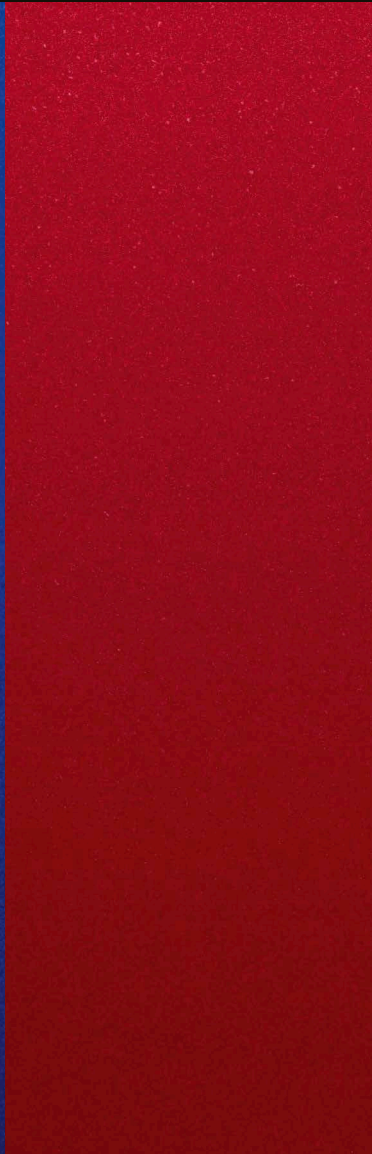

Rossello Red



PREMIUM PALETTE

Carpathian Grey



Silicon Silver

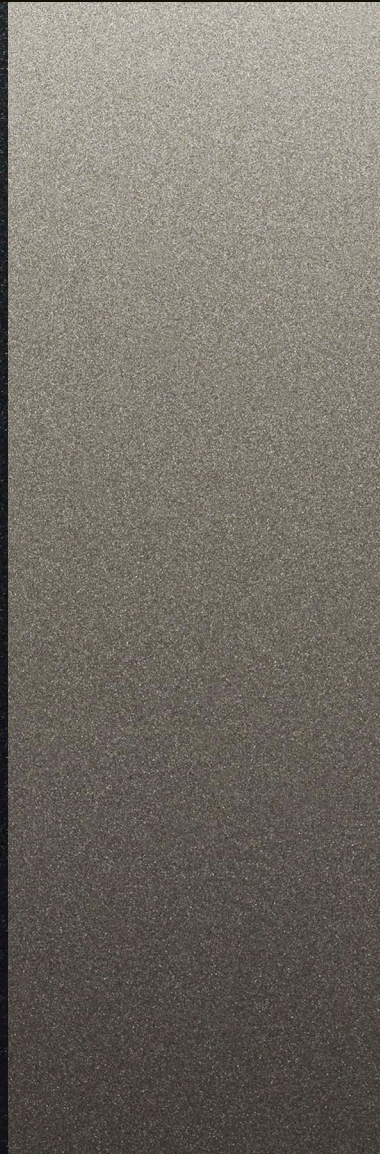

4 CHOOSE YOUR WHEELS

 Configure your vehicle at jaguar.co.uk



17" 10 SPOKE
'STYLE 1017'^{1,2}



17" 15 SPOKE
'STYLE 1016'³



17" 9 SPOKE
'STYLE 9005'³



18" 5 SPOKE
'STYLE 5034'^{4,7}



18" 7 SPLIT-SPOKE
'STYLE 7011'⁷

ALLOY WHEEL FINISH	Silver	Silver	Silver	Silver	Silver
ALLOY WHEEL/SIZE	7.5J x 17"	7.5J x 17"	7.5J x 17"	8.0J x 18"	8.0J x 18"
TYRE SIZE	225/55 R17	225/55 R17	225/55 R17	245/45 R18	245/45 R18
CODE	029WT	029WU	029WV	029WK	029WL
Prestige	<input type="radio"/>	<input checked="" type="radio"/> ^{4,5,6}	<input type="radio"/> <input checked="" type="radio"/> ^{7,8}	<input type="radio"/> ⁹	<input type="radio"/>
Portfolio	<input checked="" type="radio"/>	<input type="radio"/> ^{2,5}	<input type="radio"/> ^{1,2}	<input type="radio"/>	<input checked="" type="radio"/>
R-Sport	<input type="radio"/>	<input type="radio"/> ^{2,5}	<input checked="" type="radio"/> ^{1,2}	<input type="radio"/>	<input type="radio"/>
S	—	—	—	—	—



18" 5 SPLIT-SPOKE
'STYLE 5033'⁷



18" 5 SPLIT-SPOKE
'STYLE 5033'⁷



18" 5 SPLIT-SPOKE
'STYLE 5033'⁷



19" 7 SPLIT-SPOKE
'STYLE 7012'⁷



19" 7 SPLIT-SPOKE
'STYLE 7013'⁷

ALLOY WHEEL FINISH	Silver	Contrast/Diamond Turned	Gloss Black	Silver	Silver
ALLOY WHEEL/SIZE	8.0J x 18"	8.0J x 18"	8.0J x 18"	8.0J x 19"	8.0J x 19"
TYRE SIZE	245/45 R18	245/45 R18	245/45 R18	245/40 R19	245/40 R19
CODE	029WM	029WJ	029WH	029WN	029WO
Prestige	<input type="radio"/>	<input type="radio"/>	<input type="radio"/>	<input type="radio"/>	<input type="radio"/>
Portfolio	<input type="radio"/>	<input type="radio"/>	<input type="radio"/>	<input type="radio"/>	<input type="radio"/>
R-Sport	<input checked="" type="radio"/>	<input type="radio"/>	<input type="radio"/>	<input type="radio"/>	<input type="radio"/>
S	—	—	—	<input type="radio"/>	<input type="radio"/>

● Standard ○ Option — Not Applicable

¹Not available on XF Sportbrake. ²Only available with XF Saloon models with 2.0 litre 4-cylinder 163PS Diesel engine. ³Only available with 4-cylinder engines, excluding 300PS engines.

⁴Optional on XF Sportbrake with 180PS Diesel and 250PS Petrol engines. ⁵Standard on XF Sportbrake with 2.0 litre 4-cylinder 163PS Diesel engine. ⁶Optional on XF Sportbrake with 2.0 litre 4-cylinder 240PS AWD Diesel engine. ⁷Not available with 2.0 litre 4-cylinder 163PS Diesel engine. ⁸Standard on XF Sportbrake. ⁹Standard on 300PS engines.

On XF Sportbrake, when space saver wheel is fitted, 19" is the maximum wheel size permissible for the fitment of detachable tow bar 028EM and electrically deployable tow bar 028EJ.



19" 7 SPLIT-SPOKE
'STYLE 7013'¹⁷



19" 10 SPOKE
'STYLE 1018'¹⁷



19" 5 SPOKE
'STYLE 5035'¹⁷



19" 5 SPOKE
'STYLE 5035'¹⁷



20" 9 SPLIT-SPOKE
'STYLE 9004'¹⁷

ALLOY WHEEL FINISH	Contrast/Diamond Turned	Silver	Gloss Dark Grey/Diamond Turned	Gloss Black	Silver
ALLOY WHEEL/SIZE	8.0J x 19"	8.0J x 19"	8.0J x 19"	8.0J x 19"	8.5J x 20"
TYRE SIZE	245/40 R19	245/40 R19	245/40 R19	245/40 R19	255/35 R20
CODE	029WS	029WP	029WR	029WQ	029WB
Prestige	<input type="radio"/>	<input type="radio"/>	<input type="radio"/>	<input type="radio"/>	<input type="radio"/>
Portfolio	<input type="radio"/>	<input type="radio"/>	<input type="radio"/>	<input type="radio"/>	<input type="radio"/>
R-Sport	<input type="radio"/>	<input type="radio"/>	<input type="radio"/>	<input type="radio"/>	<input type="radio"/>
S	<input type="radio"/>	<input type="radio"/>	<input checked="" type="radio"/>	<input type="radio"/>	<input type="radio"/>



20" 9 SPLIT-SPOKE
'STYLE 9004'¹⁷



20" 5 SPLIT-SPOKE
'STYLE 5071'¹⁷



20" 5 SPLIT-SPOKE
'STYLE 5031'¹⁷



20" 5 SPLIT-SPOKE
'STYLE 5031'¹⁷



20" 5 SPLIT-SPOKE
'STYLE 5036'¹⁷

ALLOY WHEEL FINISH	Contrast/Diamond Turned	Silver	Gloss Dark Grey/Diamond Turned	Gloss Black	Gloss Dark Grey/Diamond Turned
ALLOY WHEEL/SIZE	8.5J x 20"	8.5J x 20"	8.5J x 20"	8.5J x 20"	8.5J x 20"
TYRE SIZE	255/35 R20	255/35 R20	255/35 R20	255/35 R20	255/35 R20
CODE	029WC	029WD	029VZ	029WE	029WA
Prestige	<input type="radio"/>	<input type="radio"/>	<input type="radio"/>	<input type="radio"/>	<input type="radio"/>
Portfolio	<input type="radio"/>	<input type="radio"/>	<input type="radio"/>	<input type="radio"/>	<input type="radio"/>
R-Sport	<input type="radio"/>	<input type="radio"/>	<input type="radio"/>	<input type="radio"/>	<input type="radio"/>
S	<input type="radio"/>	<input type="radio"/>	<input type="radio"/>	<input type="radio"/>	<input type="radio"/>

5 CHOOSE YOUR INTERIOR

 Configure your vehicle at jaguar.co.uk

PRESTIGE						
	SEAT WITH TONAL STITCH	UPPER FACIA WITH TONAL STITCH	INTERIOR TRIM AND OPTION CODES	HEADLINING SUEDECLOTH ¹	CARPET	VENEER
Standard						
Grained leather seats	Ebony with Ebony	Ebony with Ebony	TRC	Ebony ² or Light Oyster	Ebony	Gloss Black
	Latte with Latte	Espresso with Espresso	TRD	Light Oyster	Espresso	Gloss Black
	Light Oyster with Light Oyster	Oyster with Oyster	TRE	Light Oyster	Oyster	Gloss Black
PORTFOLIO						
	SEAT WITH TONAL STITCH	UPPER FACIA WITH TONAL STITCH	INTERIOR TRIM AND OPTION CODES	HEADLINING SUEDECLOTH ¹	CARPET	VENEER
Standard						
Windsor leather seats	Ebony with Ebony	Ebony with Ebony	TRN	Ebony ² or Light Oyster	Ebony	Gloss Figured Ebony
	Latte with Latte	Espresso with Espresso	TRO	Light Oyster	Espresso	Gloss Figured Ebony
	Light Oyster with Light Oyster	Oyster with Oyster	TRP	Light Oyster	Oyster	Gloss Figured Ebony
	Espresso with Espresso	Espresso with Espresso	TRR	Light Oyster	Espresso	Gloss Figured Ebony
	Siena Tan with Siena Tan	Ebony with Ebony	TRQ	Ebony ² or Light Oyster	Ebony	Gloss Figured Ebony

¹Morzine headlining available as an option.

²Ebony headlining available as an option.

³Light Oyster headlining available as an option.

R-SPORT						
	DUO TONE SEAT WITH CONTRAST STITCH	UPPER FACIA WITH CONTRAST STITCH	INTERIOR TRIM AND OPTION CODES	HEADLINING SUEDECLOTH¹	CARPET	VENEER
Standard						
Grained leather sports seats	Ebony/Ebony with Light Oyster	Ebony with Light Oyster	TRF + 033YF	Ebony or Light Oyster ³	Ebony	Gloss Black
	Ebony/Pimento with Pimento	Ebony with Pimento	TRG + 033YF	Ebony or Light Oyster ³	Ebony	Gloss Black
	Ebony/Light Oyster with Light Oyster	Ebony with Light Oyster	TRH + 033YF	Ebony or Light Oyster ³	Ebony	Gloss Black
	Brogue/Brogue with Light Oyster	Ebony with Light Oyster	TRI + 033YF	Ebony or Light Oyster ³	Ebony	Gloss Black
S						
	DUO TONE SEAT WITH CONTRAST STITCH	UPPER FACIA WITH CONTRAST STITCH	INTERIOR TRIM AND OPTION CODES	HEADLINING SUEDECLOTH¹	CARPET	VENEER
Standard						
Grained leather sports seats	Ebony/Ebony with Light Oyster	Ebony with Light Oyster	TRJ + 033YF	Ebony or Light Oyster ³	Ebony	Grey Figured Ebony
	Pimento/Ebony with Ebony	Ebony with Pimento	TRK + 033YF	Ebony or Light Oyster ³	Ebony	Grey Figured Ebony
	Light Oyster/Ebony with Ebony	Ebony with Light Oyster	TRL + 033YF	Ebony or Light Oyster ³	Ebony	Grey Figured Ebony
	Brogue/Brogue with Light Oyster	Ebony with Light Oyster	TRM + 033YF	Ebony or Light Oyster ³	Ebony	Grey Figured Ebony
Option						
Sports grained leather seats with suedecloth inserts	Ebony/Ebony with Light Oyster	Ebony with Light Oyster	TRJ	Ebony or Light Oyster ³	Ebony	Grey Figured Ebony
	Pimento/Ebony with Ebony	Ebony with Pimento	TRK	Ebony or Light Oyster ³	Ebony	Grey Figured Ebony

5 CHOOSE YOUR INTERIOR

Configure your vehicle at jaguar.co.uk











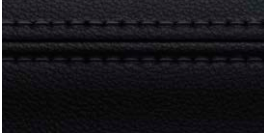

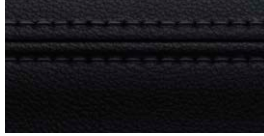
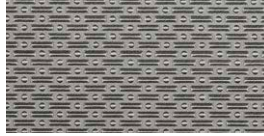

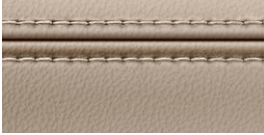
Interior shown: Ebony grained leather seats with Ebony tonal stitch, Ebony facia, Morse Code Aluminium finisher, Gloss Black veneer and optional Ebony headlining.

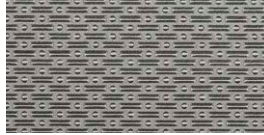

PRESTIGE

INTERIOR COLOUR COMBINATIONS

STANDARD

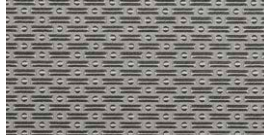
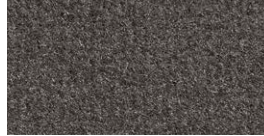
1	2	3	4	5	6
SEAT WITH TONAL STITCH	VENEER	HEADLINING SUEDECLOTH ¹	UPPER FACIA WITH TONAL STITCH	FINISHER	CARPETS
					
Ebony with Ebony	Gloss Black	Ebony ² or Light Oyster	Ebony with Ebony	Morse Code Aluminium	Ebony
					
Latte with Latte	Gloss Black	Light Oyster	Espresso with Espresso	Morse Code Aluminium	Espresso
					
Light Oyster with Light Oyster	Gloss Black	Light Oyster	Oyster with Oyster	Morse Code Aluminium	Oyster

VENEER OPTIONS

Carbon Fibre Veneer, Satin Burr Ash Veneer, Gloss Figured Ebony Veneer, Grey Figured Ebony Veneer, Satin Fine Line Veneer, Satin Rosewood Veneer or Gloss Burr Walnut Veneer

¹Morzine headlining available as an option.
²Ebony headlining available as an option.

5 CHOOSE YOUR INTERIOR

Configure your vehicle at jaguar.co.uk











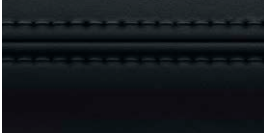

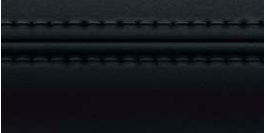

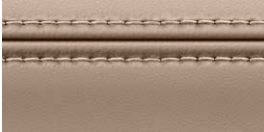







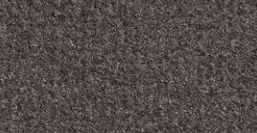
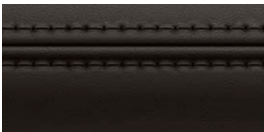

Interior shown: Latte Windsor leather seats with Latte tonal stitch, Espresso facia, Morse Code Aluminium finisher, Gloss Figured Ebony veneer and Light Oyster headlining.

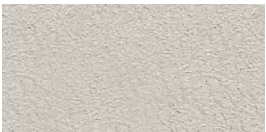
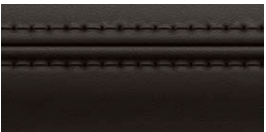

PORTFOLIO

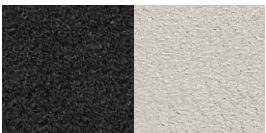
INTERIOR COLOUR COMBINATIONS

STANDARD

1	2	3	4	5	6
SEAT WITH TONAL STITCH	veneer	HEADLINING SUEDECLOTH ¹	UPPER FACIA WITH TONAL STITCH	FINISHER	CARPETS
					
Ebony with Ebony	Gloss Figured Ebony	Ebony ² or Light Oyster	Ebony with Ebony	Morse Code Aluminium	Ebony
					
Latte with Latte	Gloss Figured Ebony	Light Oyster	Espresso with Espresso	Morse Code Aluminium	Espresso
					
Light Oyster with Light Oyster	Gloss Figured Ebony	Light Oyster	Oyster with Oyster	Morse Code Aluminium	Oyster
					
Espresso with Espresso	Gloss Figured Ebony	Light Oyster	Espresso with Espresso	Morse Code Aluminium	Espresso
					
Siena Tan with Siena Tan	Gloss Figured Ebony	Ebony ² or Light Oyster	Ebony with Ebony	Morse Code Aluminium	Ebony

VENEER OPTIONS

Gloss Black Veneer, Carbon Fibre Veneer, Satin Burr Ash Veneer, Grey Figured Ebony Veneer, Satin Fine Line Veneer, Satin Rosewood Veneer or Gloss Burr Walnut Veneer

¹Morzine headlining available as an option.

²Ebony headlining available as an option.

5 CHOOSE YOUR INTERIOR

⚙️ Configure your vehicle at jaguar.co.uk













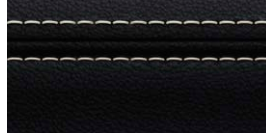
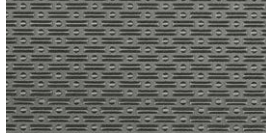

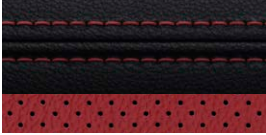

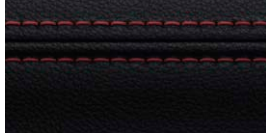
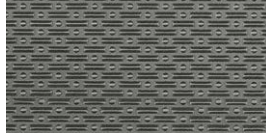



Interior shown: Ebony and Light Oyster perforated grained leather sports seats with Light Oyster contrast stitch, Ebony facia with Light Oyster contrast stitch, Dark Morse Code Aluminium finisher, optional Satin Fine Line veneer and optional Light Oyster headlining.

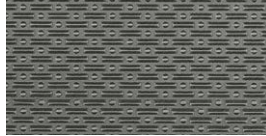

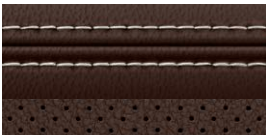
R-SPORT

INTERIOR COLOUR COMBINATIONS

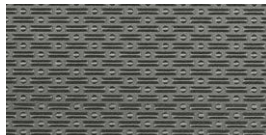
STANDARD

1	2	3	4	5	6
<p>DUO TONE SEAT WITH CONTRAST STITCH</p>  <p>Ebony/Ebony with Light Oyster</p>	<p>VENEER</p>  <p>Gloss Black</p>	<p>HEADLINING SUEDECLOTH¹</p>  <p>Ebony or Light Oyster²</p>	<p>UPPER FACIA WITH CONTRAST STITCH</p>  <p>Ebony with Light Oyster</p>	<p>FINISHER</p>  <p>Dark Morse Code Aluminium</p>	<p>CARPETS</p>  <p>Ebony</p>
 <p>Ebony/Pimento with Pimento</p>	 <p>Gloss Black</p>	 <p>Ebony or Light Oyster²</p>	 <p>Ebony with Pimento</p>	 <p>Dark Morse Code Aluminium</p>	 <p>Ebony</p>
 <p>Ebony/Light Oyster with Light Oyster</p>	 <p>Gloss Black</p>	 <p>Ebony or Light Oyster²</p>	 <p>Ebony with Light Oyster</p>	 <p>Dark Morse Code Aluminium</p>	 <p>Ebony</p>
 <p>Brogue/Brogue with Light Oyster</p>	 <p>Gloss Black</p>	 <p>Ebony or Light Oyster²</p>	 <p>Ebony with Light Oyster</p>	 <p>Dark Morse Code Aluminium</p>	 <p>Ebony</p>

VENEER OPTIONS

Carbon Fibre Veneer, Satin Burr Ash Veneer, Gloss Figured Ebony Veneer, Grey Figured Ebony Veneer, Satin Fine Line Veneer, Satin Rosewood Veneer or Gloss Burr Walnut Veneer

¹Morzine headlining available as an option.

²Light Oyster headlining available as an option.

5 CHOOSE YOUR INTERIOR

Configure your vehicle at jaguar.co.uk











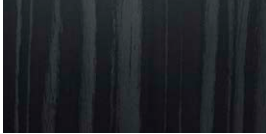

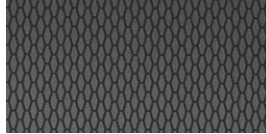

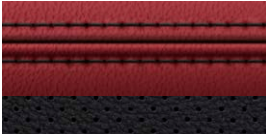

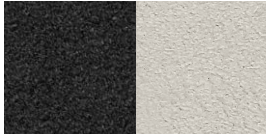
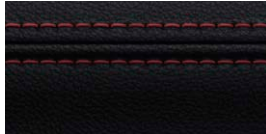
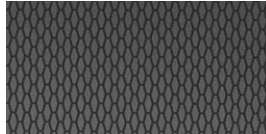
Interior shown: Light Oyster and Ebony perforated grained leather sports seats with Ebony contrast stitch, Ebony facia with Light Oyster contrast stitch, Dark Hex Aluminium finisher, Grey Figured Ebony veneer and Ebony headlining.

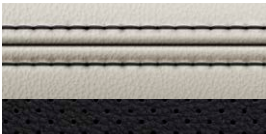

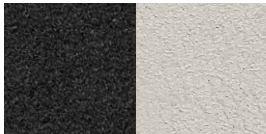
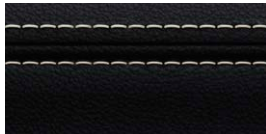
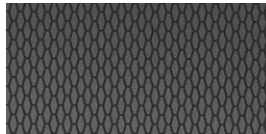
S

INTERIOR COLOUR COMBINATIONS

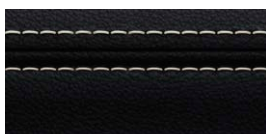
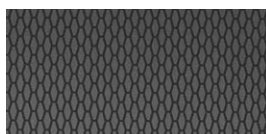
STANDARD

1	2	3	4	5	6
<p>DUO TONE SEAT WITH CONTRAST STITCH</p>  <p>Ebony/Ebony with Light Oyster</p>	<p>VENEER</p>  <p>Grey Figured Ebony</p>	<p>HEADLINING SUEDECLOTH¹</p>  <p>Ebony or Light Oyster²</p>	<p>UPPER FACIA WITH CONTRAST STITCH</p>  <p>Ebony with Light Oyster</p>	<p>FINISHER</p>  <p>Dark Hex Aluminium</p>	<p>CARPETS</p>  <p>Ebony</p>
 <p>Pimento/Ebony with Ebony</p>	 <p>Grey Figured Ebony</p>	 <p>Ebony or Light Oyster²</p>	 <p>Ebony with Pimento</p>	 <p>Dark Hex Aluminium</p>	 <p>Ebony</p>
 <p>Light Oyster/Ebony with Ebony</p>	 <p>Grey Figured Ebony</p>	 <p>Ebony or Light Oyster²</p>	 <p>Ebony with Light Oyster</p>	 <p>Dark Hex Aluminium</p>	 <p>Ebony</p>
 <p>Brogue/Brogue with Light Oyster</p>	 <p>Grey Figured Ebony</p>	 <p>Ebony or Light Oyster²</p>	 <p>Ebony with Light Oyster</p>	 <p>Dark Hex Aluminium</p>	 <p>Ebony</p>

VENEER OPTIONS

Gloss Black Veneer, Carbon Fibre Veneer, Satin Burr Ash Veneer, Gloss Figured Ebony Veneer, Satin Fine Line Veneer, Satin Rosewood Veneer or Gloss Burr Walnut Veneer

¹Morzine headlining available as an option.

²Light Oyster headlining available as an option.

5 CHOOSE YOUR INTERIOR

Configure your vehicle at jaguar.co.uk









Interior shown: Ebony grained leather sports seats with Ebony suedecloth inserts and Light Oyster contrast stitch, Ebony facia with Light Oyster contrast stitch, Dark Hex Aluminium finisher, Grey Figured Ebony veneer and Ebony headlining.

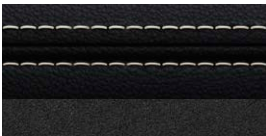

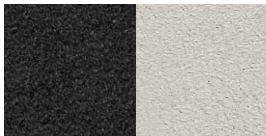
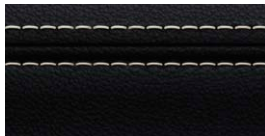
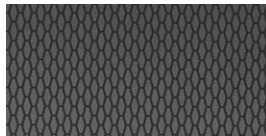
S

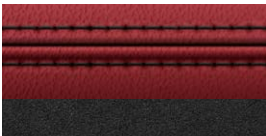
INTERIOR COLOUR COMBINATIONS

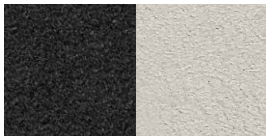
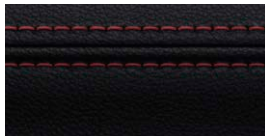
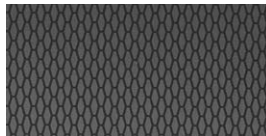
OPTION

①	②	③	④	⑤	⑥
DUO TONE SEAT WITH CONTRAST STITCH	VENEER	HEADLINING SUEDECLOTH ¹	UPPER FACIA WITH CONTRAST STITCH	FINISHER	CARPETS
					
Ebony/Ebony with Light Oyster	Grey Figured Ebony	Ebony or Light Oyster ²	Ebony with Light Oyster	Dark Hex Aluminium	Ebony
					
Pimento/Ebony with Ebony	Grey Figured Ebony	Ebony or Light Oyster ²	Ebony with Pimento	Dark Hex Aluminium	Ebony

VENEER OPTIONS

Gloss Black Veneer, Carbon Fibre Veneer, Satin Burr Ash Veneer, Gloss Figured Ebony Veneer, Satin Fine Line Veneer, Satin Rosewood Veneer or Gloss Burr Walnut Veneer

¹Morzine headlining available as an option.

²Light Oyster headlining available as an option.

5 CHOOSE YOUR INTERIOR

 Configure your vehicle at jaguar.co.uk

Gloss Black Veneer

Carbon Fibre Veneer

Satin Burr Ash Veneer

Gloss Figured Ebony Veneer



Grey Figured Ebony Veneer



Satin Fine Line Veneer



Satin Rosewood Veneer



Gloss Burr Walnut Veneer

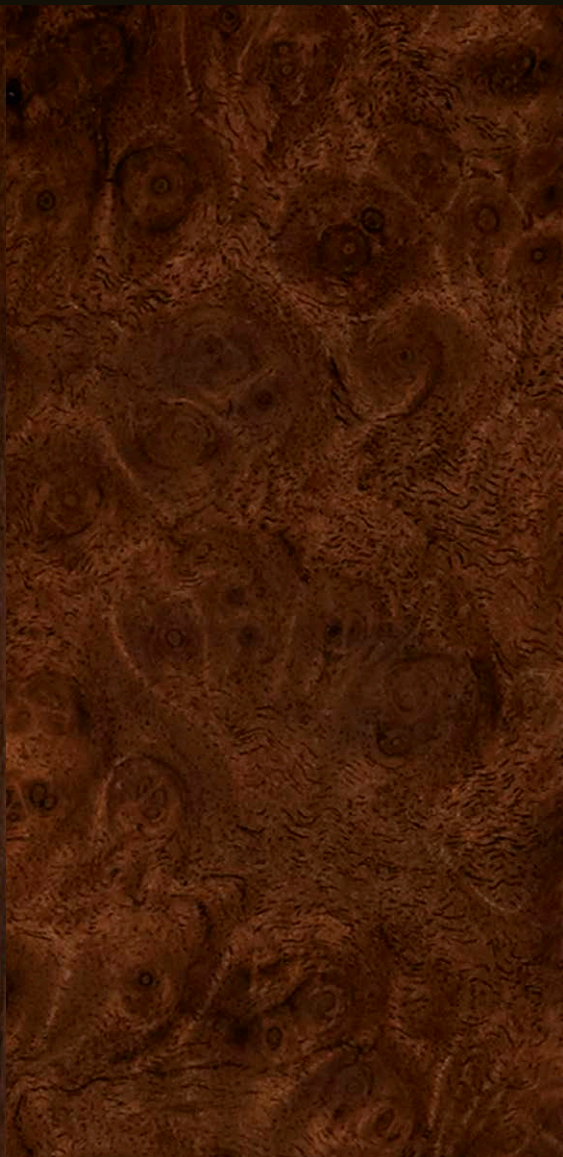

6 CHOOSE YOUR JAGUAR GEAR - ACCESSORIES

The genuine range of accessories from Jaguar.

 Configure your vehicle at jaguar.co.uk



Water Sports Carrier* **C2Z21730**

A versatile system for transporting a variety of water sports equipment including surfboard, kayak or sailboard. Tilts to facilitate loading/unloading.

*Requires roof cross bars T2H14468.

VEHICLE SHOWN: XF SALOON S IN YULONG WHITE WITH OPTIONAL FEATURES FITTED



Aluminium Gearshift Paddles
T2R6547 Aluminium Automatic transmission only
T2R6547CAY Aluminium, Red Automatic transmission only

Replacement steering wheel gearshift paddles offered in a premium aluminium material providing a high quality finish to a key contact point in the vehicle. Manufactured from billet machined aluminium, the paddles are hand brushed for a premium finish and anodised to ensure they will not deteriorate with wear.



Luxury Carpet Mats
T2H7172PVJ

Luxurious, tailored 2,050g/m² pile front carpet mats with embossed Jaguar logo and Nubuck edge binding. The premium mats provide a well appointed finishing touch to the interior.



Central Armrest Chiller/Warmer
T2H7739

Food and drinks chiller and warmer that acts as a rear centre armrest. With a leather-covered top, it is held in place by the centre seat belt and powered from the rear auxiliary socket. Ideal for long journeys with the family.



Click and Play - iPad Mini
J9C2165

The Click and Play iPad Mini holder is part of the Click and Go range. This removable tablet holder attachment can easily be positioned at multiple angles for in-cabin comfort and rear entertainment.



Personalised Illuminated Sill Treadplates
T2H17122PVJ

Elegantly styled stainless steel sill treadplate finishers for driver or passenger doors. Illuminates when either the driver or passenger doors are opened. Highlighted by soft Phosphor Blue lighting. Allows you to specify a monochrome 'motif' in a choice of approved typefaces/scripts.



Rubber Mats
T2H7741
T2H24470 - AWD

Hard wearing Jaguar branded rubber mats provide added protection for your vehicle's carpets.

6 CHOOSE YOUR JAGUAR GEAR - ACCESSORIES

 Configure your vehicle at jaguar.co.uk



Gloss Black Side Vent¹
T2H19534 - Left Side
T2H19531 - Right Side

Jaguar branded, Gloss Black side power vents provide a dynamic exterior styling enhancement.



Carbon Fibre Side Vent
T2H18319 - Left Side
T2H18318 - Right Side

High grade Carbon Fibre side power vents provide a performance-inspired styling upgrade.



Noble Chrome Mirror Caps
T2H26929

Chrome mirror covers accentuate the stylish design of the exterior mirrors.



Gloss Black Mirror Covers
C2D6067PEC - Left Side
C2D6066PEC - Right Side

Gloss Black mirror covers accentuate the dynamic design of the exterior mirrors.



Carbon Fibre Mirror Covers
C2P24176 - Right Side
C2P24177 - Left Side

High grade Carbon Fibre mirror covers provide a performance-inspired styling upgrade.



Rear Tailgate Trim - Gloss Black²
T2H17748

Add style and visual distinction with Gloss Black finish rear tailgate trim.

¹R-Sport requires Left side - T2H19535 and Right side - T2H19532. ²Only available on XF Saloon. ³Requires roof cross bars T2H14468.



Roof Cross Bars²
T2H14468

Jaguar branded cross bars required for fitting all roof carrying equipment. Engineered specifically for your vehicle.



Roof Luggage Box³
C2C41628

Spacious 410 litre capacity lockable roof luggage box, measuring 175 x 82 x 45cm.



Roof Sport Box³
C2C41627

Spacious 320 litre capacity lockable roof box designed for sports equipment, measuring 206 x 84 x 34cm.



Ski/Snowboard Holder³
C2A1538

A safe and secure Jaguar branded system for transporting winter sports equipment. Incorporates slider rails for easy loading. For four pairs of skis or two snowboards.



Fork Mounted Cycle Carrier³
C2A1540

Fitted to the roof, the fork mounted cycle carrier provides a simple and secure fitting with the bike front wheel removed, ideally suited to lightweight bikes and 'racing' wheels. A separate carrier is included for the front wheel. Easy to fit, lockable cycle carrier which carries one bike per holder. A maximum of three holders can be fitted.



Tow Bar Mounted Cycle Carrier
C2Z22694 - 2 Bike
C2Z22696 - 3 Bike

Premium tow ball mounted cycle carriers provide a convenient bike carrying solution with quick release loading attachments and secure locking mechanism. Clever design allows carrier to be tilted away from vehicle when fitted allowing access into the rear tailgate.

6 CHOOSE YOUR JAGUAR GEAR - ACCESSORIES

The genuine range of accessories from Jaguar.

 Configure your vehicle at jaguar.co.uk



Wheel Mounted Cycle Carrier¹ C2A1539

An easy to fit, roof mounted, lockable cycle carrier which carries one bike per holder. A maximum of three holders can be fitted.

¹Requires roof cross bars T2H24300. ²Only available on XF Sportbrake.

VEHICLE SHOWN: XF SPORTBRAKE S IN YULONG WHITE WITH OPTIONAL FEATURES FITTED



Roof Cross Bar²
T2H24300

Jaguar branded cross bars required for fitting all roof carrying equipment. Engineered specifically for your vehicle.



Roof Sport Box¹
C2C41627

Spacious 320 litre capacity lockable roof box designed for sports equipment, measuring 206 x 84 x 34cm.



Fork Mounted Cycle Carrier¹
C2A1540

Fitted to the roof, the fork mounted cycle carrier provides a simple and secure fitting with the bike front wheel removed, ideally suited to lightweight bikes and 'racing' wheels. A separate carrier is included for the front wheel. Easy to fit, lockable cycle carrier which carries one bike per holder. A maximum of three holders can be fitted.



Water Sports Carrier¹
C2Z21730

A versatile system for transporting a variety of water sports equipment including surfboard, kayak or sailboard. Tilts to facilitate loading/unloading.



Ski/Snowboard Holder¹
C2A1538

A safe and secure Jaguar branded system for transporting winter sports equipment. Incorporates slider rails for easy loading. For four pairs of skis or two snowboards.



Tow Bar Mounted Cycle Carrier
C2Z22694 - 2 Bike
C2Z22696 - 3 Bike

Premium tow bar mounted cycle carriers provide a convenient bike carrying solution with quick release loading attachments and secure locking mechanism. Clever design allows the carrier to be tilted away from vehicle when fitted allowing access into the rear tailgate.

6 CHOOSE YOUR JAGUAR GEAR - ACCESSORIES

 Configure your vehicle at jaguar.co.uk



Click and Play - iPad® 2-4
J9C2163

Click and Play is a removable tablet holder attachment which is available for various tablets, and can be easily positioned in multiple angles for in cabin comfort and rear entertainment.



Click and Hook
J9C2169

Click and Hook is a universal hook that creates extra storage space for items to be hung.



Click and Hang
J9C2167

Click and Hang is a removable coat hanger allowing for shirts and jackets to be kept crease-free whilst transporting.



Union Jack Sill Treadplates
T2H17123PVJ - Jet
T2H17123AMT - Oyster

Elegantly styled stainless steel sill treadplate finisher for driver or passenger doors featuring a distinctly British design.



Sport Pedal Covers
T2H3747 - Manual
T2H3746 - Automatic (not shown)

Made from stainless steel and rubber, the pedal kit fits securely over existing pedals for a contemporary, sporting appearance. Standard on 'S'.



Luggage Compartment Waterproof Liner¹
T2H24704

Total protection for the luggage compartment and second row seat back. Bespoke developed for XF Sportbrake, the liner is a fully waterproof and is easy to fit or remove in a matter of minutes.

¹Only available on XF Sportbrake. ²Pet pack can be fitted with either Rubber Liner (T2H25062) or Rubber Mat (T2H24552).



Aperture Retention Net¹
T2H31242

The aperture retention net prevents small items from falling out of the loadspace when the tailgate is opened and maximises packing space. Manufactured from premium lightweight materials including high grade machined aluminium to ensure robust quality.



**Pet Pack
Luggage Guard¹**
T2H31273

Combines the loadspace rubber mat with the full height partition, to protect both your vehicle and your pet. The rubber mat is waterproof, protecting the vehicle's loadspace floor carpet. The full height partition prevents access to the passenger compartment, while safely containing and protecting your pet.

**Luggage Compartment
Rubber Liner²**
T2H25062



Luggage Compartment Collapsible Organiser
T2H7752

Collapsible luggage compartment organiser keeps items from shifting during transport with two durable straps.



Luggage Compartment Rubber Mat¹
T2H24552

This premium mat is tailored specifically to protect the luggage compartment. Light and durable, it is easily removable for cleaning.



Luggage Compartment Multi-purpose Liner¹
T2H24651

All-in-one premium loadspace carpet mat and double layer reversible rubber liner helps protect the rear loadspace area from general dirt. The liner can be folded out to cover the back of the second row seats when folded down. Also includes fold out bumper protector.



Bumper Protector¹
T2H24701

Provides protection for the rear bumper from scuffs and scratches and helps to prevent clothing from collecting dirt when loading and unloading.

TECHNICAL DETAILS

 Configure your vehicle at jaguar.co.uk

ENGINES		2.0 LITRE 4-CYLINDER TURBOCHARGED DIESEL			
Capacity	cc	1,999			
Maximum power	EEC-PS (kW)	163 (120)			
@rev/min	rpm	4,000			
Maximum torque	EEC-Nm (lb.ft.)	380 (280)			
@rev/min	rpm	1,750-2,500			
PERFORMANCE		XF SALOON		XF SPORTBRAKE	
		MANUAL RWD	AUTO RWD	MANUAL RWD	AUTO RWD
0-60 mph	seconds	9.3	8.6	9.5	8.8
0-100 km/h	seconds	9.8	9.1	10	9.3
Top speed	mph (km/h)	132 (212)	132 (212)	132 (212)	132 (212)
FUEL CONSUMPTION ¹					
Combined Fuel Economy	mpg (l/100km)	Up to 57.6 (From 4.9)	Up to 54.3 (From 5.2)	Up to 55.4 (From 5.1)	Up to 52.3 (From 5.4)
Combined CO ₂ Emissions	g/km	From 129	From 138	From 134	From 142
Tank capacity (usable)	ltr approx.	55	55	55	55
DIMENSIONS					
Overall length	mm	4,954		4,955	
Overall width (inc. mirrors)	mm	2,091		2,091	
Overall width (mirrors folded)	mm	1,987		1,987	
Overall height	mm	1,457		1,496	
Wheelbase	mm	2,960		2,960	
Front track	mm	1,605 (1,597 20" wheels)		1,605 (1,597 20" wheels)	
Rear track	mm	1,594 (1,586 20" wheels)		1,607 (1,599 20" wheels)	
Ground clearance	mm	110-116		111	
Turning circle diameter (kerb-to-kerb)	m	11.61		11.61	
Boot volume	litres	540		565	
WEIGHT ²					
Weight from	kg	1,699	1,720	1,727	1,753
Gross vehicle weight	kg	2,190	2,230	2,260	2,260
ENGINE AVAILABILITY					
Prestige		●		●	
Portfolio		●		●	
R-Sport		●		●	
S		—		—	

● Available — Not Available

¹All figures are manufacturer's targets and subject to final confirmation ahead of production. Note that CO₂ and fuel economy figures can vary according to wheel fitment, and the lowest figures may not be achievable with the standard wheels. ²Weights reflect vehicles to standard specifications. Optional extras increase weight.

		20d 2.0 LITRE 4-CYLINDER TURBOCHARGED DIESEL		
ENGINES				
Capacity	cc	1,999		
Maximum power	EEC-PS (kW)	180 (132)		
@rev/min	rpm	4,000		
Maximum torque	EEC-Nm (lb.ft.)	430 (318)		
@rev/min	rpm	1,750-2,500		
		XF SALOON		XF SPORTBRAKE
PERFORMANCE		MANUAL RWD	AUTO RWD/AWD	AUTO RWD/AWD
0-60 mph	seconds	8.7	7.9/8	8/8.1
0-100 km/h	seconds	9.2	8.4/8.5	8.5/8.6
Top speed	mph (km/h)	136 (219)	136 (219)	136 (219)
FUEL CONSUMPTION¹				
Combined Fuel Economy	mpg (l/100km)	Up to 55.4 (From 5.1)	Up to 54.3/50.4 (From 5.2/5.6)	Up to 53.3/49.6 (From 5.1/5.7)
Combined CO ₂ Emissions	g/km	From 133	From 138/148	From 134/150
Tank capacity (usable)	ltr approx.	66	66	66
DIMENSIONS				
Overall length	mm	4,954		4,955
Overall width (inc. mirrors)	mm	2,091		2,091
Overall width (mirrors folded)	mm	1,987		1,987
Overall height	mm	1,457		1,496
Wheelbase	mm	2,960		2,960
Front track	mm	1,605 (1,597 20" wheels)		1,605 (1,597 20" wheels)
Rear track	mm	1,594 (1,586 20" wheels)		1,607 (1,599 20" wheels)
Ground clearance	mm	110-116		111
Turning circle diameter (kerb-to-kerb)	m	11.61		11.61
Boot volume	litres	540		565
WEIGHT²				
Weight from	kg	1,719	1,734/1,771	1,789/1,842
Gross vehicle weight	kg	2,270	2,295/2,340	2,320/2,375
ENGINE AVAILABILITY				
Prestige		●		●
Portfolio		●		●
R-Sport		●		●
S		—		—

TECHNICAL DETAILS

 Configure your vehicle at jaguar.co.uk

ENGINES		20d 2.0 LITRE 4-CYLINDER TWIN TURBOCHARGED DIESEL		30d 3.0 LITRE V6 6-CYLINDER TWIN TURBOCHARGED DIESEL	
Capacity	cc	1,999		2,993	
Maximum power	EEC-PS (kW)	240 (177)		300 (221)	
@rev/min	rpm	4,000		4,000	
Maximum torque	EEC-Nm (lb.ft.)	500 (368)		700 (516)	
@rev/min	rpm	1,500		1,500 - 1,750	

PERFORMANCE		XF SALOON AUTO AWD	XF SPORTBRAKE AUTO AWD	XF SALOON AUTO RWD	XF SPORTBRAKE AUTO RWD
0-60 mph	seconds	6.5	6.7	6.0	6.1
0-100 km/h	seconds	6.9	7	6.4	6.6
Top speed	mph (km/h)	153 (246)	150 (241)	155 (250)	155 (250)

FUEL CONSUMPTION ¹		XF SALOON AUTO AWD		XF SPORTBRAKE AUTO AWD	
Combined Fuel Economy	mpg (l/100km)	Up to 47.9 (From 5.9)		Up to 46.3 (From 6.1)	
Combined CO ₂ Emissions	g/km	From 156		From 160	
Tank capacity (usable)	ltr approx.	66		66	

DIMENSIONS		XF SALOON AUTO AWD	XF SPORTBRAKE AUTO AWD	XF SALOON AUTO RWD	XF SPORTBRAKE AUTO RWD
Overall length	mm	4,954	4,955	4,954	4,955
Overall width (inc. mirrors)	mm	2,091	2,091	2,091	2,091
Overall width (mirrors folded)	mm	1,987	1,987	1,987	1,987
Overall height	mm	1,457	1,496	1,457	1,496
Wheelbase	mm	2,960		2,960	
Front track	mm	1,605 (1,597 20" wheels)	1,605 (1,597 20" wheels)	1,605 (1,597 20" wheels)	1,605 (1,597 20" wheels)
Rear track	mm	1,594 (1,586 20" wheels)	1,607 (1,599 20" wheels)	1,594 (1,586 20" wheels)	1,607 (1,599 20" wheels)
Ground clearance	mm	110-116	111	119	111
Turning circle diameter (kerb-to-kerb)	m	11.61	11.61	11.61	11.61
Boot volume	litres	540	565	540	565

WEIGHT ²		XF SALOON AUTO AWD	XF SPORTBRAKE AUTO AWD	XF SALOON AUTO RWD	XF SPORTBRAKE AUTO RWD
Weight from	kg	1,808	1,875	1,878	1,924
Gross vehicle weight	kg	2,370	2,395	2,390	2,430

ENGINE AVAILABILITY		XF SALOON AUTO AWD	XF SPORTBRAKE AUTO AWD	XF SALOON AUTO RWD	XF SPORTBRAKE AUTO RWD
Prestige		●	●	—	—
Portfolio		●	●	●	●
R-Sport		●	●	—	—
S		—	—	●	●

● Available — Not Available

¹All figures are manufacturer's targets and subject to final confirmation ahead of production. Note that CO₂ and fuel economy figures can vary according to wheel fitment, and the lowest figures may not be achievable with the standard wheels. ²Weights reflect vehicles to standard specifications. Optional extras increase weight.

ENGINES		25t 2.0 LITRE 4-CYLINDER TURBOCHARGED PETROL		30t 2.0 LITRE 4-CYLINDER TURBOCHARGED PETROL	
		Capacity	cc	1,997	
Maximum power	EEC-PS (kW)	250 (184)		300 (221)	
@rev/min	rpm	5,500		5,500	
Maximum torque	EEC-Nm (lb.ft.)	365 (269)		400 (295)	
@rev/min	rpm	1,300-4,500		1,500-4,500	

PERFORMANCE		XF SALOON		XF SPORTBRAKE	
		AUTO RWD		AUTO AWD	
0-60 mph	seconds	6.4		6.5	
0-100 km/h	seconds	6.7		6.9	
Top speed	mph (km/h)	152 (244)		150 (241)	

FUEL CONSUMPTION ¹		XF SALOON		XF SPORTBRAKE	
		AUTO RWD		AUTO AWD	
Combined Fuel Economy	mpg (l/100km)	Up to 38.2 (From 7.4)		Up to 37.2 (From 7.6)	
Combined CO ₂ Emissions	g/km	From 168		From 173	
Tank capacity (usable)	ltr approx.	74		74	

DIMENSIONS		XF SALOON		XF SPORTBRAKE	
		AUTO RWD		AUTO AWD	
Overall length	mm	4,954		4,955	
Overall width (inc. mirrors)	mm	2,091		2,091	
Overall width (mirrors folded)	mm	1,987		1,987	
Overall height	mm	1,457		1,457	
Wheelbase	mm	2,960		2,960	
Front track	mm	1,605 (1,597 20" wheels)		1,605 (1,597 20" wheels)	
Rear track	mm	1,594 (1,586 20" wheels)		1,594 (1,586 20" wheels)	
Ground clearance	mm	110-116		111	
Turning circle diameter (kerb-to-kerb)	m	11.61		11.61	
Boot volume	litres	540		565	

WEIGHT ²		XF SALOON		XF SPORTBRAKE	
		AUTO RWD		AUTO AWD	
Weight from	kg	1,704		1,775	
Gross vehicle weight	kg	2,260		2,290	

ENGINE AVAILABILITY		XF SALOON	XF SPORTBRAKE
Prestige		●	●
Portfolio		●	●
R-Sport		●	●
S		—	—

XF SALOON DIMENSIONS

 Configure your vehicle at jaguar.co.uk

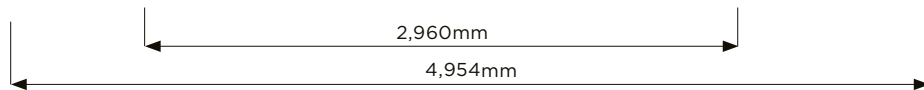

Vehicle Height

With roof antenna 1,457mm

Headroom

Maximum front headroom with Fixed Metal roof fitted 957mm
Rear headroom 1,445mm

Legroom

Maximum front legroom 1,055mm
Maximum rear legroom 957mm

Loadspace Capacity

Rear seats upright

Height 953mm, Width 970mm
Loadspace volume 540 Litres
Loadspace width between arches 991mm
Length at floor 686mm

Rear seats forward

Height 953mm, Width 970mm
Loadspace volume 885 Litres
Loadspace width between arches 991mm
Length at floor 1,045mm

Turning Circle

Kerb-to-kerb 11.61m
Wall-to-wall 11.94m
Turns lock-to-lock 2.5

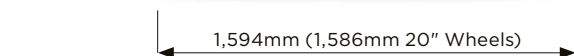
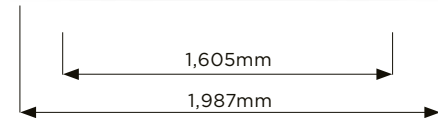

XF SPORTBRAKE DIMENSIONS



Vehicle Height

With roof antenna 1,496mm

Headroom

Maximum front headroom with Fixed Metal roof fitted 991mm
Rear headroom 995mm

Legroom

Maximum front legroom 1,055mm
Maximum rear legroom 957mm

Loadspace Capacity

Rear seats upright

Height 635mm, Width 1,057mm
Loadspace volume 565 Litres
Loadspace width between arches 1,058mm
Length at floor 1,111mm

Rear seats forward

Height 635mm, Width 1,057mm
Loadspace volume 1,700 Litres
Loadspace width between arches 1,058mm
Length at floor 1,970mm

Turning Circle

Kerb-to-kerb 11.61m
Wall-to-wall 11.94m
Turns lock-to-lock 2.5



SPECIAL VEHICLE OPERATIONS



Special Vehicle Operations (SVO) designs and engineers products that amplify Jaguar and Land Rover core brand values; focusing on luxury, performance and capability.

Our team of specialists is completely focused on enhancing and personalising our relationship with our most discerning and enthusiastic customers – delivering experiences that our customers will love for life.

SVO is responsible for the creation of a suite of halo products that showcase the pinnacle of Jaguar design and engineering capabilities, enabling our customers to indulge their passion for spectacular new vehicles.

THE NEW SVO TECHNICAL CENTRE

In the heart of the British Midlands is SVO's brand new Technical Centre. This state-of-the-art facility represents a £20m investment by Jaguar Land Rover, and features four zones designed to support the creation of truly breath-taking vehicles. In addition to the Commissioning and Presentation suites, our manufacturing centre is responsible for the assembly and hand-finishing of SVO halo and Collector's Edition vehicles, and a world-class paint facility ensures an exquisite finish for every car we create.

BESPOKE BY SVO

Bespoke by SVO was born out of an innate understanding of what our most discerning clients value more than anything else – to own something completely unique to them. Something only they can have, reflecting who they are and what they hold most dear. With that in mind, SVO developed innovative Commissioning and Presentation suites enabling creation of the most refined and luxurious vehicles in the world. This special new facility is housed within the new SVO Technical Centre in Warwickshire, England.



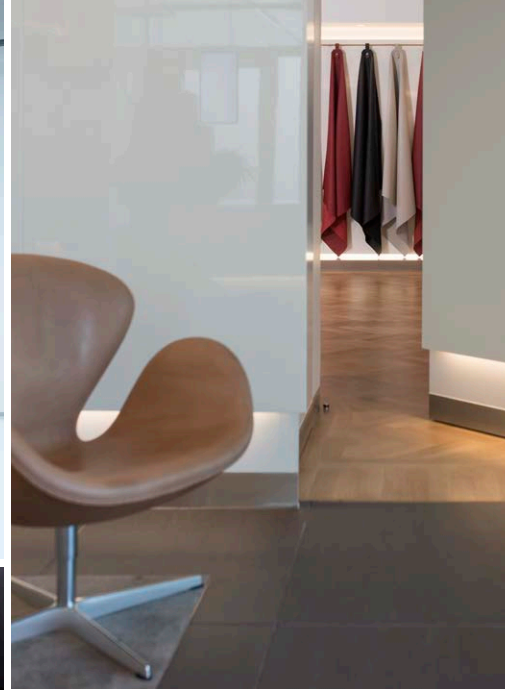

THE WORLD OF JAGUAR

Choose XF and you're joining the exciting World of Jaguar.

TRACK DAYS

There's no better way to get to know Jaguar than by taking a drive. The Jaguar Experience offers a range of unique opportunities to really find out what it feels like to get the most out of a Jaguar. Our track experiences allow you to push yourself and cars from the incredible Jaguar range to the limit.

Find out more by visiting jaguar.co.uk/experience-jaguar

BEHIND THE SCENES

Our factory tours give you the unique opportunity to experience the whole process of how our cars are brought to life – from the moulding of sheet metal to those intricate final touches. At our state-of-the-art production facilities, you'll get to see how skilled technicians and sophisticated machines work seamlessly together to perfect some of Jaguar's most breathtaking cars.

Find out more at jaguar.co.uk/experience-jaguar/factory-tours

ICE DRIVE EXPERIENCES

Take your driving to the next level with the Jaguar Land Rover Ice Drive Experience. From 2017, we are offering an adventure in Arjeplog, Sweden, that will test and develop your performance driving skills in extreme conditions. It's a rare chance for owners and enthusiasts to tackle some of the harshest and most challenging tracks on earth, under the skilled guidance of our experts. Our driving instructors are of the highest calibre and will be with you every step of the way – ready to impart years of driving wisdom. You will dance on ice, glide around some of the most awe-inspiring corners imaginable and realise the true exhilarating potential of Jaguar and Land Rover.

If you'd like to be part of the next adventure, find out more by visiting jaguar.co.uk/experience-jaguar/in-the-driving-seat





FORMULA E

Jaguar's reputation for performance, technology and design was forged by the world's most challenging circuits and championships. From Le Mans to Formula 1, and now Formula E, the grid is our test-bed. Formula E provides the perfect proving ground for electric vehicle technology in a high performance environment. The racing series accelerates the development of Jaguar's electric powertrains. With every race, Formula E helps Jaguar engineers create better electric vehicles.

Find out more by visiting jaguar.co.uk/jaguar-racing

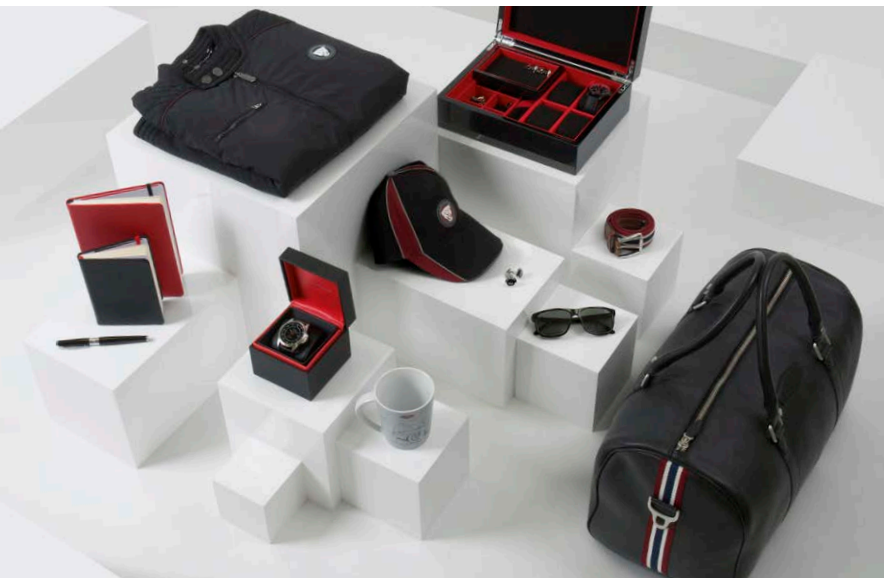

JAGUAR COLLECTION

The latest range from the Jaguar Collection has been crafted with the same design execution and attention to detail that goes into all of our cars. This is evident in our clothing range, premium leather items and luxury travel goods. To celebrate Jaguar's heritage, we also have a collection that honours past achievements and features race inspired gift items and apparel.

To find out more, visit the online shop at shop.jaguar.co.uk

THE JAGUAR MAGAZINE

This is our own vibrant, cosmopolitan and contemporary magazine. Produced by a team of enthusiastic designers and feature writers, it goes behind the scenes at Jaguar as well as providing insight into the world of luxury, design, style and travel. You can enjoy Jaguar Magazine twice a year completely free of charge for the first three years. Ask your local Jaguar Retailer to ensure that you receive your copy.

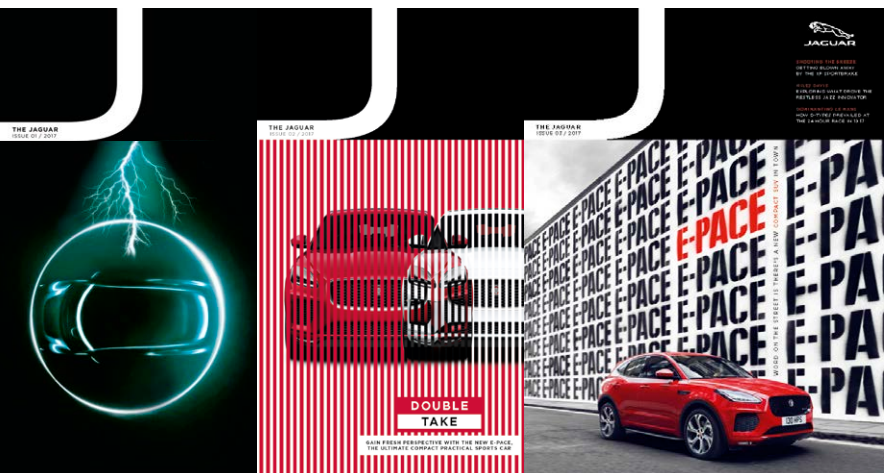



AT YOUR SERVICE

As well as providing a range of exclusive services and lifestyle products, the World of Jaguar makes owning and driving carefree and easy.

GENUINE PARTS

Jaguar Genuine Parts are designed, tested and manufactured to our uncompromising standards for quality, fit and durability. Each part is engineered specifically for your XF to contribute to optimum performance and to help maximise its lifespan.

FLEET & BUSINESS

Jaguars are dynamic and distinctive cars that help companies express the unique character and personality of their business. We are committed to providing customer-focused aftersales services, ensuring that every Jaguar performs to the highest standard and in the most cost-efficient way for businesses. Visit jaguar.co.uk/fleet-and-business for more information.

JAGUAR ASSISTANCE

Jaguar Assistance provides assistance in motoring emergencies, from immobilisation due to breakdown or accident to minor problems such as punctures. You can rely on our roadside assistance, whatever the situation, wherever you happen to be.

JAGUAR FINANCIAL SERVICES

New or used, for personal or business use, we have a finance option that puts you in complete control. Please speak to your local Jaguar Retailer to find out more.

INSURANCE

XF's key components are easily accessible for time-efficient service and repair costs. With a focus on lower repair costs, XF delivers competitive insurance group ratings. To find out more about the compelling business case for XF, please contact your local Jaguar Retailer.

IMPORTANT NOTICE

Jaguar Land Rover Limited is constantly seeking ways to improve the specification, design and production of its vehicles and alterations take place continually. While every effort is made to produce up-to-date literature, this brochure should not be regarded as an infallible guide to current specifications, nor does it constitute an offer for the sale of any particular vehicle. Distributors and Retailers are not agents of Jaguar Land Rover Limited by any express or implied undertaking or representation. Comparisons are based on manufacturer's own data and testing prior to publication.

COLOURS

The colours reproduced here are subject to the limitations of the printing process and may therefore vary slightly from the actual vehicle. The company reserves the right to alter or withdraw any colour finish without notice. Some of these colours may not be obtainable in your country. Please check availability of colours and current specifications with your Jaguar Retailer. Distributors and retailers are not agents of Jaguar Land Rover Limited and have absolutely no authority to bind Jaguar Land Rover Limited to any express or implied undertaking or representation.

ENVIRONMENTAL INNOVATION AT JAGUAR

Jaguar is committed to reducing dependency on fossil fuels, using fewer natural resources and creating less waste as part of our approach to responsible and sustainable business development.

Search 'Jaguar Environmental Innovation' for more details.

Castrol EDGE Professional exclusively recommended by Jaguar.

Meridian is the registered trademark of Meridian Audio Ltd.

The Bluetooth® word mark and logos are owned by the Bluetooth SIG, Inc. and any use of such marks by Jaguar Land Rover Limited is under license. iPhone is a trademark of Apple Inc., registered in the US and other countries. The navigation system must always be used in conditions that will not affect the driver's ability to drive safely or affect the safety of other road users.

VEHICLES SHOWN FRONT COVER: XF SPORTBRAKE S IN YULONG WHITE AND XF SALOON R-SPORT IN CORRIS GREY WITH OPTIONAL FEATURES FITTED

VEHICLES SHOWN BACK COVER: XF SPORTBRAKE S IN YULONG WHITE AND XF SALOON R-SPORT IN CORRIS GREY WITH OPTIONAL FEATURES FITTED

Jaguar Land Rover Limited
Registered Office: Abbey Road, Whitley,
Coventry, CV3 4LF, United Kingdom

Registered in England Number: 1672070

jaguar.co.uk

1X2601910000BXXEN01P
19MY / August 2018

