

Q60



INFINITI

EMPOWER THE DRIVE

INFINITI

EMPOWER THE DRIVE

We are like you. We push ourselves beyond our comfort zone. While others might be content with making better machines, we are driven to go beyond—to design cars that push human potential. We build technology to enhance your senses, striking design that demands a response and performance that makes you feel more alive. Prepare to experience the road as it was intended.



INFINITI Q60

Empower the drive with performance. We gave it daring curves and a powerful stance. The exhilarating performance of a twin-turbocharged¹ 405-horsepower V6 engine. The thrilling responsiveness of the first digitally adaptive handling system. The all-new Q60. Redefine the drive.



EXTERIOR DESIGN

EVERY LINE SHAPES AN EMOTION

Our philosophy—and the future of INFINITI design—takes stunning shape on the all-new Q60. Emotion is boundless. So is daring design.



ATHLETIC STANCE Large 19-inch alloy wheels¹ make your intentions known. Add red sport brakes with opposed front and rear callipers², and the visual message is clear: the all-new Q60 is meant to perform.

IMPRESSION AMPLIFIED INFINITI signature cues express a unique design language. The double-arch grille reflects a bridge, with the arc of the top mirroring the arc of the bottom. Optical-inspired LED headlights give a provocative stare, while the crescent-shaped C-pillar curves forward, punctuating the exterior with dynamic detail.

WELL-GROUNDED The dynamic proportions make a purpose-built statement. Low enough to hug the ground. Wide enough to deliver impressive stability.

AERODYNAMIC ADVANTAGE A .29 coefficient of drag¹ says as much time has been spent making this sports coupe invisible to the wind as striking to the eye. This is evident with near zero-lift aerodynamics in the front and rear, and an Active Grille Shutter¹ that stays closed to lower drag at speed, but opens if additional cooling is needed.

DEEP DRAMATIC CREASES Using a revolutionary 3-D stamping process that allows for aggressive creases and deep curves, the high character lines capture your imagination. Engineers even redesigned the door hinges so the leading edge tucks into the fender to provide dramatic sculpting.



INTERIOR DESIGN

A BODY OF ART CRAFTED EXPRESSLY FOR YOU

Tailored to accentuate the human form, the cabin celebrates the driver with bold thinking and fine modern materials.

VISUAL REWARD With Fine Vision electroluminescent gauges, see how quickly the needle moves under any lighting condition. The contrast delivers information clearly, helping to improve visibility at a glance.

FLEXIBLE DOORSTOP Every time you get in, you'll appreciate the exclusive flexible doorstop that can hold open in almost any position. Thanks to this smart technology, INFINITI's 2-door coupe features not only aesthetically pleasing long doors and a low sitting position that ensures comfort and convenience for both driver and passenger, but also reduces risk to the car's exterior when opening doors in tight spaces. Easy entry. Easy exit.

SPORT SEAT DESIGN Feel the sport-inspired difference. The end-product of zero gravity research, science meets style in the new shape and cushioning of the driver's seat, which is specially designed to help minimise fatigue on long drives. Deep bolsters help hold you in place and sporty integrated headrests provide the right support for a comfortable ride.

TAILORED AND ACCENTED Craftsmanship is obvious in the lasercut holes in the leather seat upholstery, which permit tighter stitching and more dynamic free-flowing shapes. Around the centre console and throughout the interior, available black or silver optic carbon-fibre trim² offers an upscale modern look.

NATURAL GRIP Your hands move in unique ways and a steering wheel should reflect that. This one does. Sport-inspired thumb grips and steering wheel-mounted paddle shifters¹ are just the right shape for performance driving¹. The all-new Q60 gear shift layout features an ergonomic knob with the INFINITI logo that's designed for smooth, effortless gear shifting.

SAFETY. COMFORT. STYLE. With no detail overlooked, the all-new Q60 comes with seatbelts that are made from a soft, durable herringbone weave that helps reduce friction so they're comfortable, snag-resistant and easy to remove when opening the clasp. Stay safe. Stay comfortable.



ACCELERATE YOUR POTENTIAL AND PERFORMANCE

This is power through innovation, where the forces of advanced technology open new horizons. A first-ever INFINITI twin-turbo engine culminates in jaw-dropping performance.

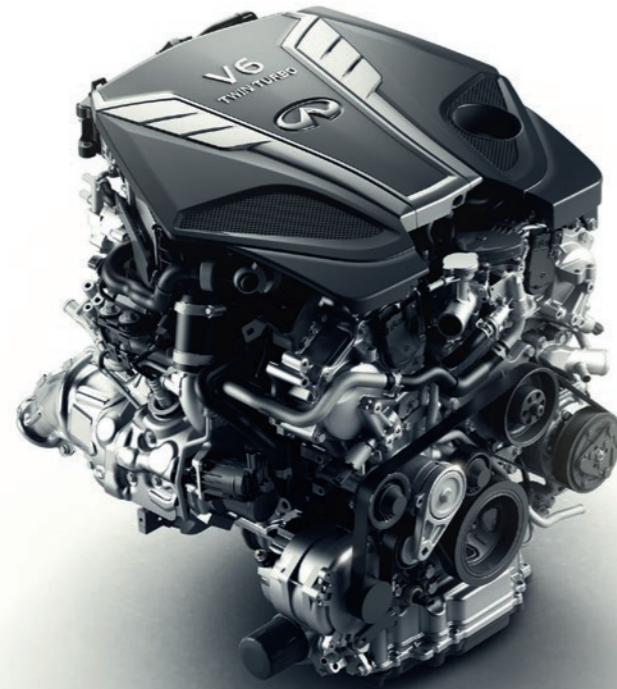

SIGN OF PERFORMANCE At INFINITI, performance is more than delivering a heightened driving experience. We believe it should unleash a more dynamic driver in you. And now, a shared passion can be boldly displayed by the letter S. Whether it is more intense power, tuning or design, the INFINITI Sport Model represents something special.



SPORT—"RED" The Red "S" badge represents the highest level of performance and power in its lineup. In the all-new Q60S 3.0t, that means a 3.0L V6 twin-turbo 405 PS engine¹.



SPORT—"SILVER" The all-new Q60S represents an enhanced styling and performance package while featuring a powerful, yet fuel-efficient powertrain—2.0t Turbocharged Petrol engine with 211 PS.



405
PS

5.0s
0-100KM/H

ALL-NEW 3.0-LITRE V6 TWIN-TURBO 405-PS ENGINE With the new V6 twin-turbo, torque builds quickly, acceleration is instant and power feels limitless. Direct Injection Gasoline (DIG), water-cooled air charging, a turbo speed sensor and advanced turbine blade design make for quicker response and a higher peak¹.



211
PS

41.5
MPG

2.0-LITRE I-4 TURBOCHARGED ENGINE Feel the rush of a turbo. Experience the fuel economy of a four-cylinder. With optimal power and efficiency, you glide forward confidently. The turbo spools quickly to produce 211 PS at 5,500 rpm and outputs a stirring 350 Nm of torque while achieving 41.5 mpg combined fuel consumption².

CLOSER THRILLS All paddle shifters are not positioned equally. In the all-new Q60, paddle shifters are steering wheel-mounted instead of column-mounted for easy reach during cornering.¹

HANDLING

AMPLIFY EVERY MOVE DIGITALLY

Unleash the full performance potential—of the all-new Q60 and yourself—with the world's first pairing of digital steering and suspension.



STEER WITH ENHANCED PRECISION When you turn the wheel, Direct Adaptive Steering² does something no other steering system can do. It transmits driver input at the speed of electrons versus the speed of mechanical linkages. Since your steering is digitally processed, you get the response you want. Smooth. Quick. Precise. Every movement is a reaction to your command, tuned for an instinctive natural connection.

FIRST DIGITALLY ADAPTIVE HANDLING SYSTEM

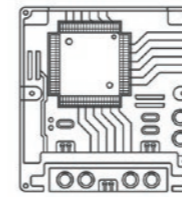

A performance car is engaging. An INFINITI is empowering. In the all-new Q60, you amplify your capabilities with a true 21st century handling system.

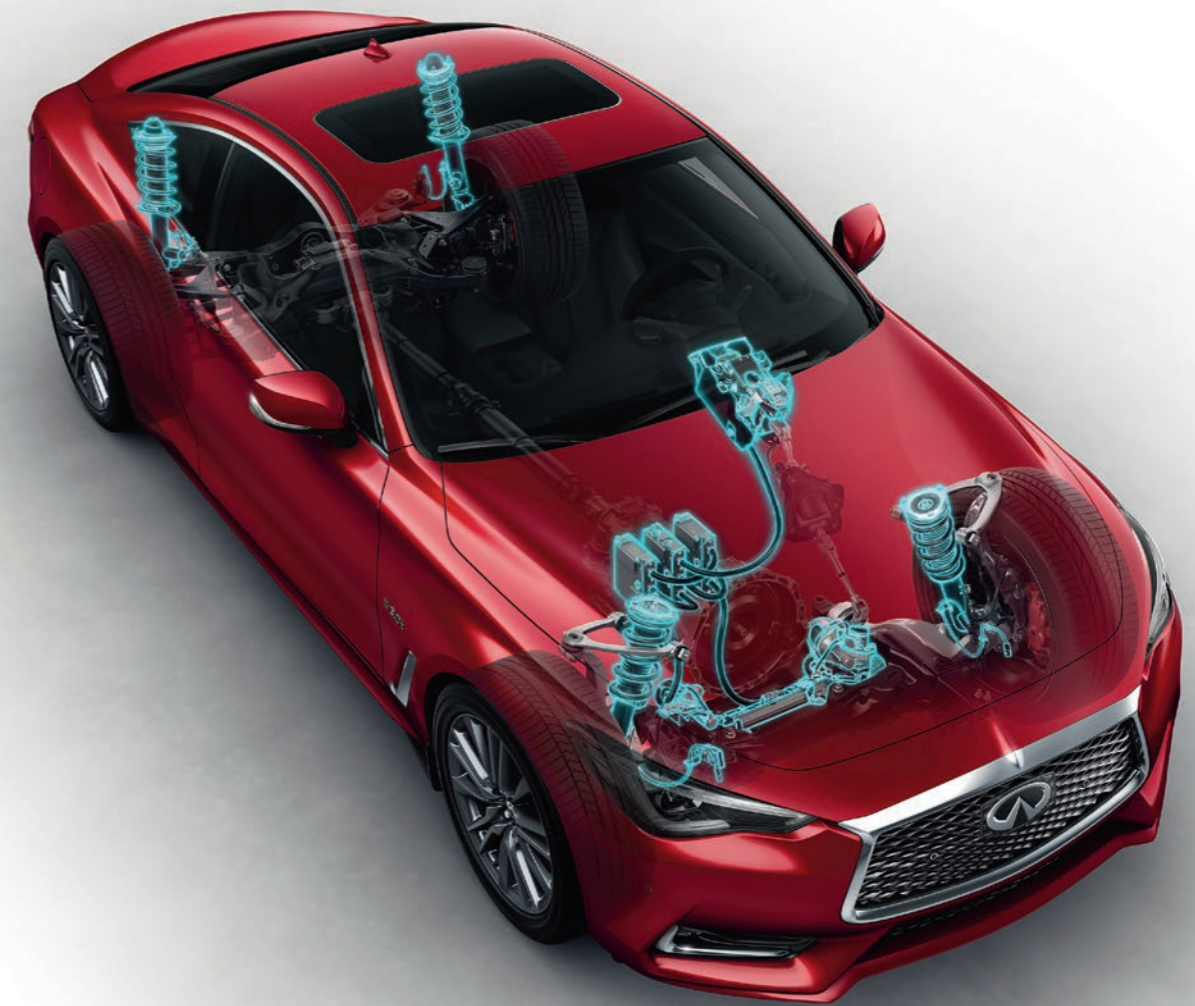

HANDLE WITH INSTANT ADAPTABILITY The all-new Q60 recalibrates the balance between comfort and performance into something revolutionary. Change from comfort-biased to dynamic ride with the push of a button and release a highly personal and responsive experience. Without you doing a thing, Dynamic Digital Suspension³ continually adjusts to corners and road imperfections for confidence on any road.

CHOOSE YOUR DRIVE The INFINITI Drive Mode Selector takes performance and control to a more refined level. Select between Standard, Snow, ECO¹, Sport, Sport+¹ and Personal modes. Then, further tailor your drive by tuning steering, engine and suspension inputs. The result is one that suits the moment, and more importantly, can be personalised exactly to your liking. Expand your experience beyond road conditions and preset factory settings.¹

MORE WAYS TO CARVE A TURN

Personalise your performance with a range of choices for steering and suspension. Grasp your freedom. Drive fully immersed in every moment.



2 STEERING SYSTEMS

(1) **DIRECT ADAPTIVE STEERING^{®1}** Today, the future is in your hands and it's moving fast. Hundreds of adjustments a second, Direct Adaptive Steering^{®1} is a worldwide first INFINITI innovation that constantly fine-tunes your steering performance. Easy manoeuvrability at low speeds. Spirited driving on winding mountain roads. The system operates by digitally transmitting your steering input both to and from the wheels for a smoother and quicker response, in addition to filtering out unwanted vibrations from the road surface or impacts of crosswinds. Fewer steering corrections are required, giving you a strong feeling of control and ease.

(2) **HYDRAULIC ELECTRIC POWER STEERING.** For those who prefer the feel of hydraulic assist, the all-new Q60 provides an easy, every-day steering experience.

2 SUSPENSION SYSTEMS

(1) **DYNAMIC DIGITAL SUSPENSION (DDS)¹** You are the driver. Let the all-new Dynamic Digital Suspension (DDS)¹ adapt to you. Enjoy a smooth ride when you want it or a more agile response when you demand it. New adaptive dampers change the focus based on your Drive Mode Selector choice. Switching between modes is instantaneous. So is the ability of DDS¹ to constantly monitor chassis vitals like body roll, pitch and bounce rate. This is driver-centric performance for the digital age.

(2) **STANDARD SUSPENSION** With a double wishbone front and an independent multi-link rear suspension, you'll enjoy a smooth level ride. Handle every twist and turn with aplomb, thanks to shock absorbers that deliver a direct, linear feel with low road noise and vibrations. From now on, you are part of a dynamic team, where every S-curve belongs to you—and the all-new Q60.

2 DRIVETRAIN SYSTEMS

REAR-WHEEL DRIVE (RWD) OR INTELLIGENT ALL-WHEEL DRIVE (AWD) To enthusiasts, nothing matches the flat-out joy of a rear-wheel drive car. But consider this: Intelligent All-Wheel Drive can send anywhere from zero to 50% of the power to the front wheels when you need it, and 100% to the rear wheels for sporty response when you don't. So you get AWD traction without sacrificing rear-wheel drive feel.¹







CONNECTIVITY

IN TOUCH WITH YOUR CONNECTED WORLD









INFINITI InTouch makes your world flow. Your life is always moving, and INFINITI InTouch with Navigation¹ and INFINITI InTouch Mobile Apps² seamlessly bring your world into your car. Stay ahead and with access to your voice, text, email, calendar, navigation and music.^{1,3}



INFINITI INTOUCH™ MOBILE APPS¹

-  EMAIL
-  CALENDAR
-  FACEBOOK®
-  GOOGLE SEARCH®

NEW INFINITI INTOUCH SERVICES^{1,3} COMING SOON

-  VEHICLE HEALTH REPORT
-  MAINTENANCE ALERT NOTIFICATION
-  "MIL-ON" (MALFUNCTION) NOTIFICATION
-  MY CAR FINDER
-  REMOTE HORN
-  REMOTE LIGHTS
-  CALL INFINITI ASSISTANCE
-  INFINITI INTOUCH™ TRACKING^{1*}

*Requires subscription (not included). InTouch Tracking not available in Bulgaria, Croatia, Luxembourg, Serbia. InTouch services vary by country.

To learn more about INFINITI InTouch™ Services Contact your INFINITI Centre.

The INFINITI InTouch Services App^{1,3} allows you to view and control remotely your vehicle.

A PREMIUM CONNECTION Every time you get into the all-new Q60, experience its seamless connection to your hand-held technology. Connecting your smartphone to INFINITI InTouch™ with Navigation¹, INFINITI InTouch Mobile Apps^{1,3} and INFINITI InTouch™ Services^{1,3} brings your world into your car. Have emails or text messages read to you. Listen to your playlist. Navigate unfamiliar streets or call your friends. The system even remembers your personal driving preferences.

EMPOWER YOUR TOUCH The INFINITI Controller puts simple, intuitive control of your technology systems at your fingertips. It allows you to interact via the inputs most intuitive to you – turning ring, touch-screen, input buttons, and even steering wheel controls—responding to you rather than you adjusting to it.

ADJUSTS TO YOU INFINITI InTouch™^{1,3} delivers an intuitive experience right from your driver's seat in the manner that best suits you. You can interact with the state-of-the-art system however you find easiest. The top screen can be operated by touch, steering wheel switches or the INFINITI Controller; it is primarily used for driving information and navigation. The bottom screen can be operated by touch and lets you manage the infotainment systems, such as audio, climate control, apps or driving performance settings¹.

BLUETOOTH® STREAMING AUDIO Turn your Bluetooth®-enabled smartphone into a source of music, and listen to your top playlists over the all-new Q60's audio system.^{1,4}

HANDS-FREE VERSATILITY With the INFINITI Bluetooth® Hands-free Phone System^{1,4}, you can make and receive wireless calls using voice recognition. No fumbling. No need for a headset. Just press a button on the steering wheel.

INFINITI NAVIGATION SYSTEM expertly helps you find your exact location and your destination, even in crowded environs. Benefit from a more intuitive view and simple interface for increased ease and confidence.¹



SOUND

A NEW STAGE FOR A NEW SOUND

Hear it here first. The new Bose® Performance Series makes its worldwide debut on the all-new Q60. Enjoy concert-like sound that envelops you, transforming the cabin into a dynamic listening experience.¹



THE LATEST FROM BOSE® For those who demand a performance-focused sound system, the new Bose® Performance Series with Advanced Staging Technology delivers. Thirteen high-performance speakers, including multiple new 255 mm and 150 x 230 mm woofers and a lightweight silk dome tweeter achieve “live performance” precision. Revel in a wide and precise soundstage, where the acoustics are always ideal.¹

PROPRIETARY DIGITAL SIGNAL PROCESSING A recent Bose® innovation, Advanced Staging Technology utilises advanced algorithms to dynamically direct music to their ideal locations within the cabin. Instruments and vocals have exceptional clarity. So from the driver’s seat, you feel as if you’re sitting in the front row at a concert.¹

IMPROVED AUDIO PERFORMANCE Immerse yourself in an exhilarating sound experience. AudioPilot® 2.0 Noise Compensation Technology constantly monitors outside sounds and adjusts the music accordingly while Centerpoint® 2.0 Surround Technology allows you to enjoy surround sound from CDs, MP3 and Digital Audio Broadcasting.¹

ACTIVE NOISE CANCELLATION Minimise unwanted road noise and create optimal listening environments with Active Noise Cancellation. The technology works by neutralising distracting sounds with an acoustically opposite signal. The quieter the cabin, the better the music and conversation.¹

ACOUSTIC GLASS Create serenity all around you. Thin sound-absorbing material between the glass layers significantly reduces noise, delivering a more personal driving experience.

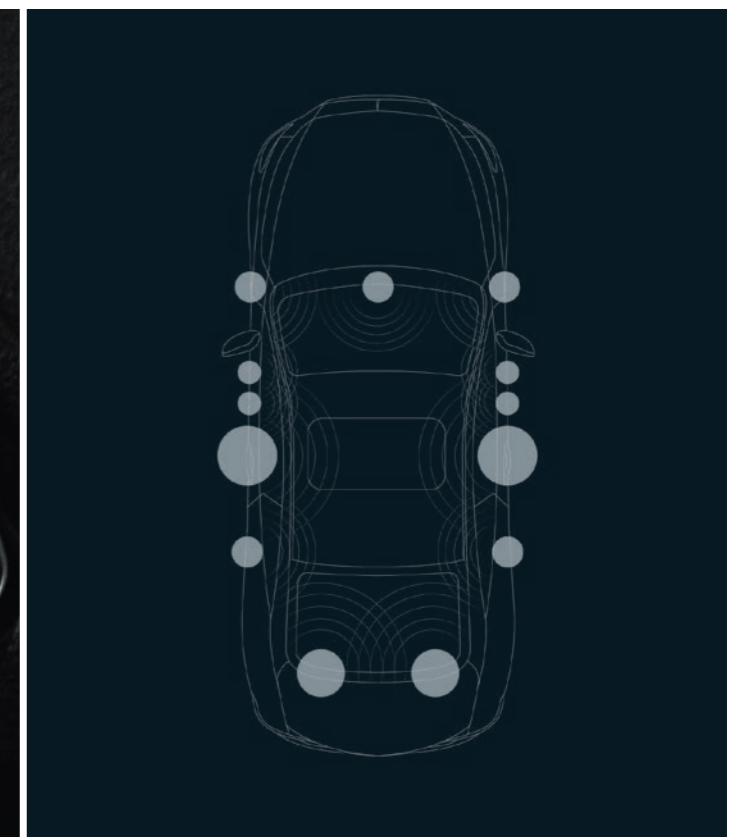

EFFORTLESSLY EXTEND YOUR ABILITIES

Driver-enhancing technologies allow you to move with a new level of ease on the road, by enabling smarter cruising, faster responses, improved visibility both in front of and around you, and more effortless steering.

CRUISE SMARTER

Set your desired speed and safety distance and Intelligent Cruise Control (ICC)^{1,5} with Distance Control Assist (DCA)¹ will automatically and smoothly decelerate in slowing traffic. When traffic pace resumes, Intelligent Cruise Control (ICC) will bring you back up to your preset speed and safety distance.

RESPOND FASTER

High Beam Assist automatically dims your high beams as oncoming vehicles approach, and turns them back on when traffic clears.¹

SEE FURTHER

The Adaptive Front lighting System (AFS) improves visibility at intersections and around curves by sensing your steering and turning the headlights. Together with LED auto-leveling headlights, AFS helps you see not just ahead, but around as well.¹

TRAFFIC SIGN RECOGNITION

The all-new Q60 also features a Traffic Sign Recognition system, a technological breakthrough that helps alert drivers to different speed limits. A camera scans the road for signs, and any changes are displayed on the instrument panel through character recognition software. It's a simple way to maintain safe speeds and be aware of any changes up ahead.

STEER EASIER

Working with Direct Adaptive Steering[®], Active Lane Control^{1,6} proactively evaluates the road ahead and can automatically make small steering angle corrections if your allnew Q60 experiences minor direction changes due to uneven road surfaces or crosswinds. You gain an increased feeling of stability, while reducing steering wheel vibration.

VIEW CLEARER

Gain a new perspective on what's around you. With the Around View[®] Monitor (AVM) with Moving Object Detection (MOD), four cameras and one virtual 360° view from above makes it easy to see and manoeuvre in even the tightest spaces.^{1,7}



SAFETY

EFFORTLESSLY EXTEND YOUR AWARENESS

A unique combination of active and passive safety innovations enhance your ability to respond instinctively.

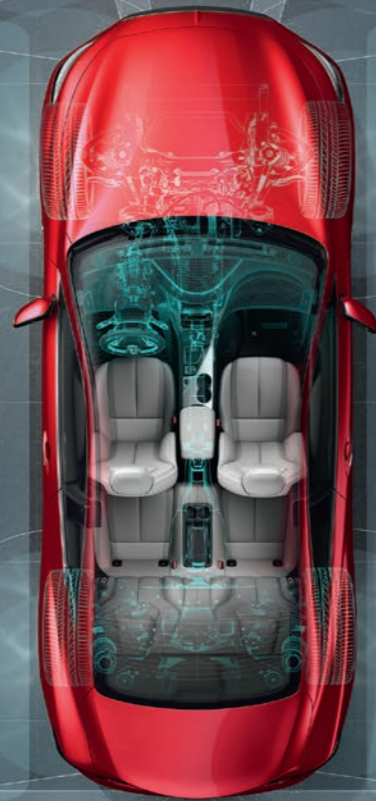

A SHIELD OF PROTECTION The INFINITI Safety Shield® concept—our comprehensive approach to safety layers technologies to monitor conditions that can help avoid a collision and protect you and your passengers if one occurs.

MORE CONFIDENT IN REVERSE Back-up Collision Intervention^{1,7} helps increase your awareness. As you back up, the system warns you if approaching vehicles or large stationary objects are detected behind your all-new Q60, and can help you avoid a collision by applying the brakes.

RESPOND TO YOUR SURROUNDINGS Forward Emergency Braking with Pedestrian Detection^{1,6} uses sensors to watch for vehicles in the lane ahead of you, and if deceleration is required, the accelerator pedal is pushed up and the brakes are applied to help minimise a collision—or possibly prevent one. It also adds another dimension of security by looking out for pedestrians who enter your vehicle's path.

BRAKE CONFIDENTLY The all-new Q60 braking system responds automatically to changing conditions with 4-wheel Anti-lock Braking System (ABS) and Electronic Brake force Distribution (EBD).

SENSES WHERE YOU CAN'T SEE The Blind Spot Warning and Blind Spot Intervention® Systems^{1,6} use sensors to detect vehicles entering the blind spot area. First, a warning light will illuminate; then, if you move toward the occupied lane, the steering wheel vibrates. A brief steering or slight braking input will also be provided to help keep your all-new Q60 in your current driving lane.

RECOGNISING DANGER Predictive Forward Collision Warning (PFCW)^{1,7} uses radar to continuously monitor not only the vehicle directly ahead of you, but also the vehicle in front of that one. If the system detects a potential risk, such as a large vehicle blocking the traffic in front of you, the all-new Q60 provides an audible and visual alert.

MAINTAIN YOUR LANE The Lane Departure Warning and Lane Departure Prevention Systems^{1,6} monitor lane markings and will warn you with a vibration through the steering wheel if you start to drift. If the drift continues, the Lane Departure Prevention System will provide brief steering input to ease your all-new Q60 back towards the centre of your lane.

STRONGER AND LIGHTER Ultra high-strength steel is twice as strong as conventional steel and is built around you to enhance your safety in case of a collision.

ENHANCED PROTECTION The all-new Q60 not only features front driver and passenger airbags, but also both front seat-mounted side-impact supplemental air bags and roof-mounted curtain side-impact supplemental air bags.⁸

PREPARED TO PROTECT Safety technology is a key feature of your all-new Q60. Pre-crash safety seatbelts¹ are automatically tightened in emergency braking situations by activating electric motors. The occupants are securely and immediately restrained before a collision occurs.

THERE SHOULD YOU NEED IT Another industry-leading, breakthrough safety feature from INFINITI is the Engine Pop-Up Bonnet¹. In the event of a front-end pedestrian collision, the all-new Q60 bonnet will pop up instantly, creating additional space above the engine which is designed to help reduce the severity of the impact.

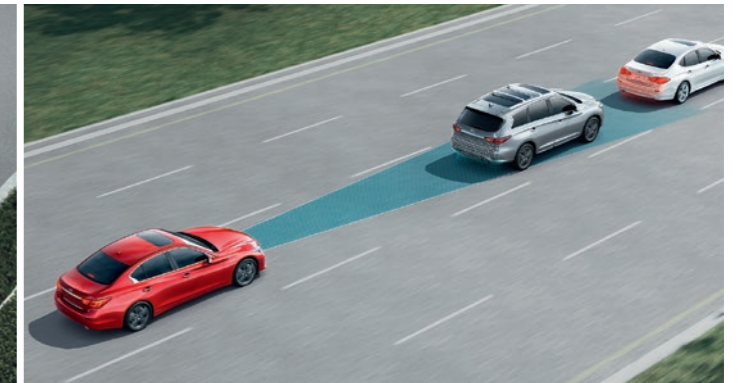

MAKE IT UNIQUELY YOURS

EXTERIOR COLOURS



WHEELS



19 X 9.0-INCH ALUMINUM-ALLOY WHEELS¹

19 X 9.0 INCH UNIQUE ALUMINUM-ALLOY WHEELS¹

INTERIOR COLOURS



INTERIOR TRIMS

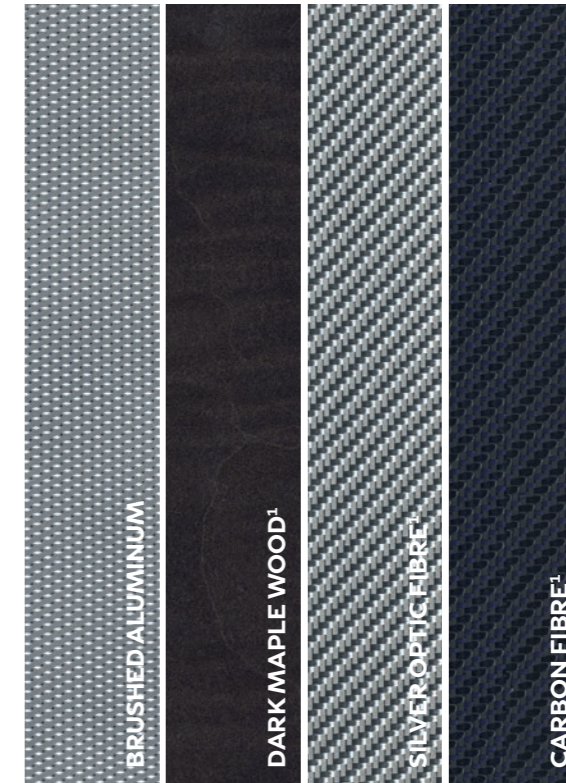

DISCLAIMERS

INFINITI Europe, Division of Nissan International SA, CH-550-1047524-0, Z.A. La Pièce – Bât. B2, Route de l'Etraz, 1180 Rolle, Switzerland

This brochure is intended for general descriptive and informational purposes only. It is subject to change and does not constitute an offer, representation or warranty (express or implied) by INFINITI Europe. Before relying on this brochure to make a purchase decision, interested parties should directly contact the INFINITI Centre to confirm the accuracy of any information given herein and how it relates to a specific vehicle. INFINITI Europe reserves the right to make changes, at any time, without prior notice, in prices, colours, materials, equipment, specifications and models and to discontinue models or equipment. Due to continuous product development and other pre- and post-production factors, the actual vehicle, materials and specifications may vary from this brochure. Some vehicles are shown with optional equipment. See the actual vehicle for complete accuracy. Availability and delivery times for particular models or equipment may vary. Specifications, options and accessories may differ in other countries. For additional information on availability, options or accessories, contact your INFINITI Centre.

INFINITI has taken care to ensure that the colour swatches presented here are the closest possible representations of actual vehicle colours. Swatches may vary slightly due to the printing process and whether viewed in daylight, fluorescent or incandescent light. Please see the actual colours at your local INFINITI Centre.

1 Optional on selected models. **2** This figure refers to the lowest official combined fuel efficiency or lowest emissions figure. Actual mileage and emissions may vary with driving conditions and other factors. Use for comparison only. **3** Minimum 24 months Subscription Agreement required. Compatible smartphone required. May require INFINITI Centre service visit or software upgrade to activate. Not all app features are available for all models. GPS map availability varies. Cellular network, apps, and services, including Google® services, are provided by independent companies not within INFINITI's control and may require subscription and owner consent to activate. Should provider terminate/restrict service, service may be terminated without notice and/or liability to INFINITI and/or its agents. Text and/or data usage rates may apply. Contact your local INFINITI Centre for details. **4** Availability of specific features is dependent upon the phone's Bluetooth® support. Please refer to your phone Owner's Manual for details. Bluetooth word mark and logos are owned by Bluetooth SIG, Inc., and any use of such marks by INFINITI is under license. Contact your INFINITI Centre for details. **5** Intelligent Cruise Control is not a collision avoidance or warning device. Designed to use limited braking only. Speed limitations apply. See Owner's Manual for details. **6** Functionality may be limited in certain road, weather or driving conditions. See Owner's Manual for details. **7** Functionality is supplementary and is not a substitute for responsible driving. Speed limitations apply. See Owner's Manual for details. **8** Air bags are only a supplemental restraint system; always wear your seat belt. Even with the occupant-classification sensor, rear-facing child restraints should not be placed in the front-passenger's seat. Except in BE and CH, all children 12 and under should ride in the rear seat properly secured in child restraints, booster seats, or seat belts according to their size. Air bags will only inflate in certain accidents; see your Owner's Manual for more details.

For further details on all features, visit the INFINITI website or see Owner's Manual.

Bluetooth word mark and logos are owned by Bluetooth SIG, Inc., and any use of such marks by INFINITI is under license. Bose is a registered trademark of the Bose Corporation. iPod is a registered trademark of Apple Inc.

Fuel economy figures for the Q60 range: fuel consumption/mpg (l/100km). Urban 21.2/30.7 (13.3/9.2), extra urban 39.8/52.3 (7.1/5.4), combined 30.1/41.5 (9.4/6.8)². CO₂ emissions 210/156 g/km.²

Fuel economy figures are obtained from laboratory testing and are intended for comparisons between vehicles and may not reflect real driving results. Optional equipment, maintenance, driving behaviour, road and weather conditions may affect the official results.

All INFINITI models for UK are right-hand driven.

Model shown: Q60S 3.0t Sport Tech with optional Silver Optic Fibre interior trim, Monaco Red or Gallery White semi-aniline leather upholstery, sunroof and metallic paint.

ACCESSORIES

GO FROM UNIQUE TO INDIVIDUAL

More accessories available
at your INFINITI Centre*

ACCESSORY LIST

- 1 Black grille
- 2 19-inch charcoal metallic performance wheel
- 3 Carbon fibre spoiler
- 4 Carbon fibre mirror covers
- 5 Carbon fibre fog lamps
- 6 Carbon fibre fender vents
- 7 Illuminated entry guards
- 8 Welcome lighting
- 9 Interior ambient lighting
- 10 Trunk area protector
- 11 Trunk organiser
- 12 Console net - passenger side
- 13 Trunk net
- 14 Premium textile mats
- 15 Rubber mats
- 16 Wheel Locks

* Some items may not be sold in your region.
Please check availability in your INFINITI Centre



2 19-INCH CHARCOAL METALLIC PERFORMANCE WHEEL



9 INTERIOR AMBIENT LIGHTING



7 ILLUMINATED ENTRY GUARDS



1 BLACK GRILLE



10 TRUNK AREA PROTECTOR

#INFINITIF1

RENAULT SPORT FORMULA ONE™ TEAM

INFINITI is proud to be technical partner
of the Renault Sport Formula One™ team.

INFINITI is technical partner of the Renault Sport Formula One™
Team for the co-development of the Power Unit's Energy Recovery
System, which recovers and deploys electric energy to boost the
internal combustion engine.

The INFINITI Engineering Academy is a global search and training
programme for the most talented students in engineering to be placed
at INFINITI Technical Centre and Renault Sport Formula One™ Team
facilities.



 | **RENAULT SPORT**
INFINITI | FORMULA ONE TEAM
TECHNICAL PARTNER

DRIVEN BY DESIRE

Design doesn't answer to logic, it answers to the heart. It begins with the artist drawing a simple line, curve or shape and loving something in it that must be fully expressed. To INFINITI, design is more than a passion, it is part of our business DNA.



In synthesis with powerful design, purity of form rises above style. Through sweeping lines and arching curves, the thing we place above all else is the artist. His sense of the future.

Alfonso Albaisa
ALFONSO ALBAISA
INFINITI DESIGN DIRECTOR

QX Sport Inspiration

WHEN A BRAND IS LED BY DESIGN, that becomes the brand's way of communicating. Every vehicle gives voice to that language through the harmony of striking lines, liquid curves and muscular stance. Proprietary elements, including the double arch grille and crescent cut, distinctly express the INFINITI design-led approach to product development and business vision. Fuelled by the power of design, an INFINITI concept car is a glimpse into tomorrow as it develops from being a sketch on the artist's table to taking its rightful place on the road.

UNDENIABLE PRESENCE. UNFORGETTABLE EXPERIENCE

The INFINITI vehicle range defies convention and redefines the premium segment through empowering technologies and expressive design.

ESTABLISHED IN 1989, INFINITI has now grown to include saloons, coupés, convertibles, crossovers and SUVs in its line-up and spans 50 countries worldwide. INFINITI is unique and distinctive—not trying to be all things to all people, but everything to some people. At the heart of the INFINITI brand is a history of human attentiveness where the belief that the total ownership experience is much more important than just the car itself, coupled with a commitment to delivering a more empowering, more assured and more exhilarating driving and ownership experience.

INFINITI HAS COME to be recognised as a brand that delivers expressive and striking car design. A distinctive design crafted by human hand and delivered with a powerful and daring presence on the road. This, combined with an obsessive attention to detail and precision engineering, all contribute to the feeling that to drive an INFINITI is something special.



FEATURES

	Q60 Premium	Q60 Premium Tech	Q60S Sport	Q60S Sport Tech
PERFORMANCE				
Stop Start system (except on 3.0-litre V6 Petrol engine)	■	■	◆	◆
Speed sensitive power steering assistance	■	■	-	-
Steering Pack	-	□	■	■
- Direct Adaptive Steering				
- Active Lane Control				
Active Trace Control	■	■	■	■
7-speed automatic transmission with manual mode	■	■	■	■
Paddle shifts	-	-	■	■
Dynamic Digital Suspension (only with 3.0-litre V6 Petrol engine)	-	-	◆	◆
Eco Pedal (only with 3.0-litre V6 Petrol engine)	-	-	-	◆
Synchronized Rev Match clutch control system for automatic transmission	■	■	■	■
SAFETY AND SECURITY				
Opposed calliper sport brakes, Dark Chrome colour painted (front 4 pistons; rear 2 pistons – only with 2.0-litre I-4 Petrol engine)	-	-	◆	◆
Opposed calliper sport brakes, Red colour painted (front 4 pistons; rear 2 pistons – only with 3.0-litre V6 Petrol engine)	-	-	◆	◆
4-wheel Anti-lock Braking System (ABS), Electronic Brake force Distribution (EBD), Traction Control System (TCS) and Vehicle Dynamic Control (VDC)	■	■	■	■
Hill start assist	■	■	■	■
Reminder for front and rear seat belts	■	■	■	■
Pop-up engine bonnet for pedestrian protection	■	■	■	■
6 airbags (front driver's and passenger airbags, front hip-thorax side airbags and front-to-rear curtain airbags)	■	■	■	■
Tyre Pressure Monitoring System (TPMS) (individual tyre pressure display)	■	■	■	■
Auto-dimming rear-view mirror	■	■	■	■
Comfort Pack	■	■	■	■
- Rain sensing wipers				
Vehicle security system with engine immobiliser and alarm	■	■	■	■
Ultrasonic alarm system	■	■	■	■
Speed limiter	■	■	■	■
Care Pack	■	-	■	-
- Cruise control				
- Brake Assist (BA)				
- Forward Emergency Braking with pedestrian detection				
- Forward Collision Warning (FCW) system				
- Predictive Forward Collision Warning (PFCW) system				
- Lane Departure Warning (LDW)				
Safety Shield Pack	-	■	-	■
- Intelligent Cruise Control (ICC) with full speed range				
- Distance Control Assist (DCA)				
- Forward Emergency Braking with pedestrian detection				
- Forward Collision Warning (FCW) system				
- Predictive Forward Collision Warning (PFCW) system				
- Lane Departure Warning (LDW) and Lane Departure Prevention (LDP)				
- Blind Spot Warning (BSW) and Blind Spot Intervention™ systems				
- Back-up Collision Intervention				
- Front Pre-Crash seat belts				
WHEELS				
19"x9" 5 spoke, 3D, Bi-tone alloy wheels with 255/40 R19 96Y Run-flat tyres	■	■	-	-
19"x9" 5 spoke, 3D, Dark chrome alloy wheels with 245/40 R19 94W Run-flat tyres	-	-	■	■
EXTERIOR				
Body colour door mirrors with LED turning signal	■	■	■	■
Heated and electrically-adjustable exterior mirrors with manual folding	■	-	-	-
Ambient Pack	□	■	■	■
- Heated, electrically-adjustable and folding exterior mirrors with reverse synchronisation				
Automatic headlight activation	■	■	■	■

	Q60 Premium	Q60 Premium Tech	Q60S Sport	Q60S Sport Tech
EXTERIOR (continues)				
LED auto-level headlights and Daytime Running Lights	■	■	■	■
LED taillights	■	■	■	■
LED fog lights (front and rear)	■	■	■	■
Follow-me home lighting system	■	■	■	■
Visibility Pack ¹	□	■	□	■
- Adaptive Front-lighting System (AFS)				
- Smart Beam				
Twin exhaust tailpipes with chrome finisher (except on 3.0-litre V6 Petrol engine)	■	■	◆	◆
Perforated twin exhaust tailpipes with chrome finisher (only with 3.0-litre V6 Petrol engine)	-	-	◆	◆
UV-reducing tinted glass	■	■	■	■
Metallic paint	□	□	□	□
Electric glass sunroof	□	□	□	□
TECHNOLOGY-ON-BOARD				
Push Button Ignition	■	■	■	■
INFINITI Drive Mode Selector	■	■	■	■
INFINITI InTouch	■	■	■	■
Dual touch-screens (LCD VGA 8" and LCD VGA 7")	■	■	■	■
Fine vision electroluminescent gauges with 3D, 5" TFT colour display	■	■	■	■
Bluetooth® technology for mobile connectivity	■	■	■	■
I-Key with smart access, luggage compartment release and enhanced memory	■	■	■	■
Comfort Pack	■	■	■	■
- Front and rear parking sensors with display				
Rear-view camera	■	-	■	-
Visibility Pack ¹	□	■	□	■
- Around View Monitor (AVM) with moving object detection and parking guidance				
Traffic sign recognition	■	■	■	■
INFINITI Navigation System with traffic information, voice recognition (for navigation functionalities) and Digital Audio Broadcasting (DAB)	■	-	-	-
Multimedia Pack	-	■	■	■
- INFINITI Navigation System with traffic information, voice recognition (for navigation functionalities) and Digital Audio Broadcasting (DAB)				
COMFORT				
Comfort Pack	■	■	■	■
- Dual zone adaptive climate control with auto-recirculation and Grape Polyphenol Filter				
Rear air conditioning vents	■	■	■	■
INFINITI InTuition™	■	■	■	■
Fully-customisable digital environment				
One-touch power windows with auto-operation linked to I-Key and pinch prevention on front windows	■	■	■	■
Attraction Light	■	■	■	■
Flexible door stop smart system	■	■	■	■
AUDIO				
AM/FM audio system with single CD player	■	■	■	■
6 speaker sound system	■	-	-	-
Multimedia Pack	-	■	■	■
- BOSE® Performance Series audio system with 13 speakers				
Active Noise Cancellation (ANC) and Active Sound Enhancement	■	■	■	■
Bluetooth® audio streaming	■	■	■	■
USB/iPod connectivity and AUX-in RCA	■	■	■	■
Voice recognition system (audio functionalities only)	■	■	■	■

¹ Only in combination with Ambient Pack.

- Standard (no additional cost)
- ◆ Standard (no additional cost, availability restricted to specified version)
- Optional (at a cost)
- Not available

COLOURS & TRIMS

	Q60 Premium	Q60 Premium Tech	Q60S Sport	Q60S Sport Tech
INTERIOR				
Multifunction steering wheel	■	■	■	■
Leather wrapped, cross-stitched sport steering wheel with Matt Chrome finish	■	■	■	■
Leather wrapped, stitched gear shift lever with Matt Chrome and Black Gloss finish	■	■	■	■
12V power outlets (2) in centre console	■	■	■	■
Manual reach and rake adjustment for steering column	■	-	-	-
Ambient Pack	□	■	■	■
- Power reach and rake adjustment for steering column				
- Ambient Lighting				
Aluminium pedals and foot rest	-	-	■	■
Brushed Aluminium interior trim	■	-	-	-
Dark Maple Wood interior trim	-	■	-	-
Carbon Fibre interior trim	-	-	■	■
Silver Optic Fibre interior trim with Monaco Red or Gallery White semi-aniline leather upholstery	-	-	□	□
Black tricot roof liner	■	■	■	■
INFINITI Aluminium front doors sill finishers	■	■	■	■
Sun visors with illuminated vanity mirrors, on driver's side with extension and card holder	■	■	■	■
Overhead sunglass storage and map lamp	■	■	■	■
SEATS				
Semi-aniline leather seat upholstery	■	■	■	■
Heated front seats	■	■	■	■
Front sport seats with 8-way electric adjustment	■	■	■	■
Driver seat's electric lumbar and side support, manual thigh extension	■	■	■	■
Ambient Pack	□	■	■	■
- Memory for driver's seat, steering wheel column and door mirrors (linked to I-Key)				
Front armrest with storage compartment and cupholders	■	■	■	■
Rear centre armrest with cup holder	■	■	■	■
Folding rear seat back rest	■	■	■	■
Electric assisted ingress/egress mechanism for easy access to rear seats	■	■	■	■
ISOFIX and top-tether seat mounting points in the rear seats	■	■	■	■
TRUNK AREA				
First aid kit with warning triangle	■	■	■	■

DIMENSIONS	
Exterior	
Overall length	4,690 mm
Overall width with mirrors	2,052 mm
Overall height without roof rails	1,390 mm
Wheelbase	2,850 mm

VARIANT/ENGINE AVAILABILITY	2.0t 7AT RWD	3.0t 7AT AWD
Q60 Premium	√	
Q60 Premium Tech	√	
Q60S Sport	√	√
Q60S Sport Tech	√	√

			Q60 Premium		Q60 Premium Tech		Q60S Sport / Q60S Sport Tech		
			Leather		Leather		Leather		
UPHOLSTERY			Graphite (Z)	Gallery White (Q)	Graphite (Z)	Gallery White (Q)	Graphite (Z)	Gallery White (Q)	Monaco Red (A)
Interior colours (Code)									
EXTERIOR COLOURS	Code	Type							
Pure White	QAW	Solid	■	■	■	■	■	■	■
Black Obsidian	KH3		■	■	■	■	■	■	■
Iridium Blue	RAY		□	□	□	□	□	□	□
Dynamic Sunstone Red	NBA	Metallic	□	□	□	□	□	□	□
Moonlight White	QAB		□	□	□	□	□	□	□
Liquid Platinum	K23		□	□	□	□	□	□	□
Graphite Shadow	KAD		□	□	□	□	□	□	□
Hagane Blue	RBP		□	□	□	□	□	□	□
Midnight Black	GAG		□	□	□	□	□	□	□
Solar Mica	EBC		□	□	□	□	□	□	□
INTERIOR TRIMS									
Brushed Aluminium			■	■	-	-	-	-	-
Dark Maple Wood			-	-	■	■	-	-	-
Carbon Fibre			-	-	-	-	■	-	-
Silver Optic Fibre			-	-	-	-	-	□	□

- Standard (no additional cost)
- ◆ Standard (no additional cost, availability restricted to specified version)
- Optional (at a cost)
- Not available

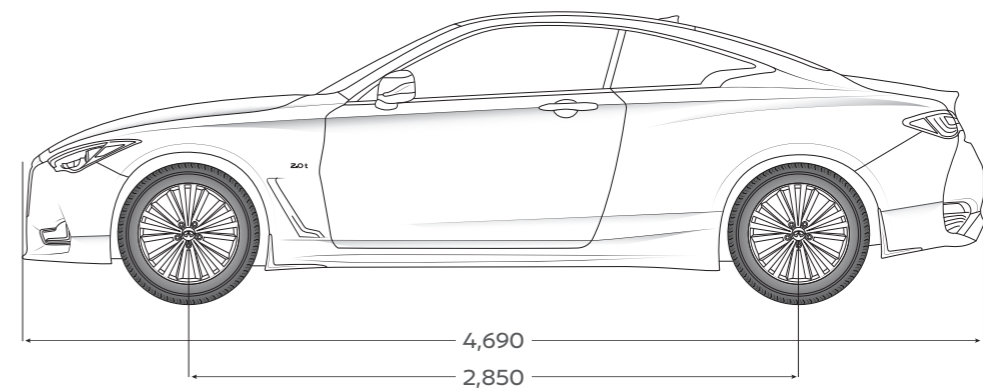
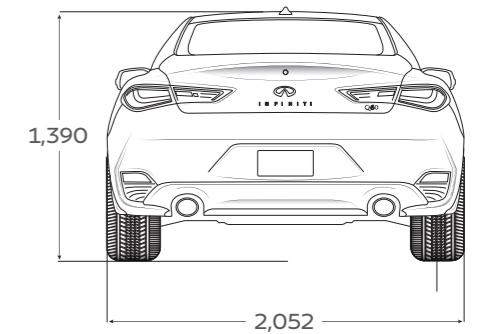
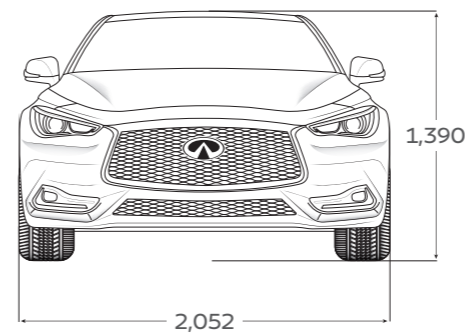

All dimensions are indicated in mm.

TECHNICAL SPECIFICATIONS

	Q60 2.0t	Q60S 3.0t
ENGINE		
Fuel Type	Petrol	Petrol
Cylinders	4	V6
Displacement	1,991 cc	2,997 cc
Valvetrain	I-4 DOHC, 16v	V-6 DOHC, 24v
Intake System	Common Rail Direct Injection (CDI)	Gasoline Direct Injection
Exhaust System	Dual exhaust system	Dual exhaust system
Power	155 kW (211 PS) at 5,500 rpm	298 kW (405 PS) at 6,400 rpm
Torque	350 Nm at 1,250–3,500 rpm	475 Nm at 1,600–5,200 rpm
Transmission	7-speed automatic transmission	7-speed automatic transmission
Driven Wheels	Rear-Wheel Drive (RWD)	All-Wheel Drive (AWD)
Emissions	Euro 6 b	Euro 6 b
PERFORMANCE		
Top Speed	146 mph	155 mph
0–62 mph (0–100 km/h)	7.3 s	5.0 s
Estimated Fuel Consumption ¹		
Urban	30.7 mpg (9.2 l/100 km)	21.2 mpg (13.3 l/100 km)
Extra-urban	52.3 mpg (5.4 l/100 km)	39.8 mpg (7.1 l/100 km)
Combined	41.5 mpg (6.8 l/100 km)	30.1 mpg (9.4 l/100 km)
CO ₂ emissions ¹	156 g/km	210 g/km
HANDLING		
Steering		
Type	Electric Power Steering ^{2,3}	–
Type	Direct Adaptive Steering ^{4,5}	Direct Adaptive Steering ^{4,5}
Suspension		
Front	Independent, double wishbone with coil springs over shock absorbers, stabiliser bar	Electronic controlled, independent, double wishbone with coil springs over shock absorbers, stabiliser bar
Rear	Independent, multi-link suspension with Dual Flow Path (DFP) shock absorbers, stabiliser bar	Electronic controlled, independent, multilink suspension with Dual Flow Path (DFP) shock absorbers, stabiliser bar
Brakes		
Front/Rear	330 mm front / 316 mm rear ventilated discs ^{2,3} ; 355 mm front / 350 mm rear ventilated discs with aluminium opposed front callipers (4-piston front, 2-piston rear) ^{4,5}	355 mm front / 350 mm rear ventilated discs with aluminium opposed front callipers (4-piston front, 2-piston rear) ^{4,5}
Wheels and Tyres		
	19"x9" 5 spoke, 3D, Bi-tone alloy wheels with 255/40 R19 96Y Run-flat tyres ^{2,3} / 19"x9" 5 spoke, 3D, Dark chrome alloy wheels with 245/40 R19 94W Run-flat tyres ^{4,5}	19"x9" 5 spoke, 3D, Dark chrome alloy wheels with 245/40 R19 94W Run-flat tyres ^{4,5}
CAPACITIES AND WEIGHTS		
Kerb weight ⁶	1,722 kg ² / 1,756 kg ³ / 1,751 kg ⁴ / 1,766 kg ⁵	– / – / 1,862 kg ⁴ / 1,879 kg ⁵
Gross Vehicle Weight (GVW)	2,140 kg	2,265 kg
Luggage volume	342 litres	342 litres
Fuel capacity	80 litres	80 litres
EXTERIOR		
Coefficient of drag	0.29 ^{2,3} / 0.30 ^{4,5}	0.30 ^{4,5}

¹ Fuel economy figures for the Q60 range: mpg (l/100km). Urban 21.2–30.7 (13.3–9.2), extra urban 39.8–52.3 (7.1–5.4), combined 30.1–41.5 (9.4–6.8), CO₂ emissions 210–156 g/km. MPG (l/100km) figures are obtained from laboratory testing and are intended for comparisons between vehicles and may not reflect real driving results. Optional equipment, maintenance, driving behaviour, road and weather conditions may affect the official results.

² Q60 Premium ³ Q60 Premium Tech ⁴ Q60S Sport ⁵ Q60S Sport Tech
⁶ Figures quoted according to Directive 92/21/EC, version 95/48/EC (kerb weight with 90% fuel tank filling, 68 kg for the driver and 7 kg for luggage) for standard-specification vehicles. Optional equipment and accessories may increase this figure.





INFINITI

EMPOWER THE DRIVE

Visit us online to create your ideal INFINITI, get pricing and more.

www.infiniti.co.uk

CONNECT Join our community, and get the latest on INFINITI.

-  [Facebook.com/InfinitiGB](https://www.facebook.com/InfinitiGB)
-  [Instagram.com/InfinitiUK](https://www.instagram.com/InfinitiUK)
-  [Twitter.com/InfinitiEurope](https://www.twitter.com/InfinitiEurope)