



Q7

Audi Q7

Vorsprung durch Technik **Audi** 



		Page		
Fascination				
<hr/>				
	4	Audi Q7		
Technology				
<hr/>				
30	Audi innovations	36	Light technologies	42
32	Audi connect	38	Assistance systems	44
34	Simplexity	40	quattro®	
Equipment				
<hr/>				
48	Style guides	60	Wheels/tyres	71
50	Engines	62	Seats	74
52	S line	66	Inlays	77
54	Audi design selection	68	Lights	81
56	Audi exclusive	69	Design	83
58	Paint finishes	70	Steering wheels/controls	85
Other				
<hr/>				
86	Audi Genuine Accessories	92	Dimensions	102
90	Technical data	94	Index	The fascination of Audi

The equipment for the vehicles illustrated in the Fascination section can be found on page 101.
The fuel consumption and CO₂ emission figures can be found on page 90.



The fuel consumption and CO₂ emission figures can be found on page 90.



**Greatness
starts, when
you don't stop.**



quattro

IN Q 7001



**The epitome of quattro® – given progressive form.
Powerful and striking.**

The fuel consumption and CO₂ emission figures can be found on page 90.



**Everything an Audi Q7 should be:
athletic, timeless, unique.**



The fuel consumption and CO₂ emission figures can be found on page 90.



IN Q 7001

Q7

TDI
quattro

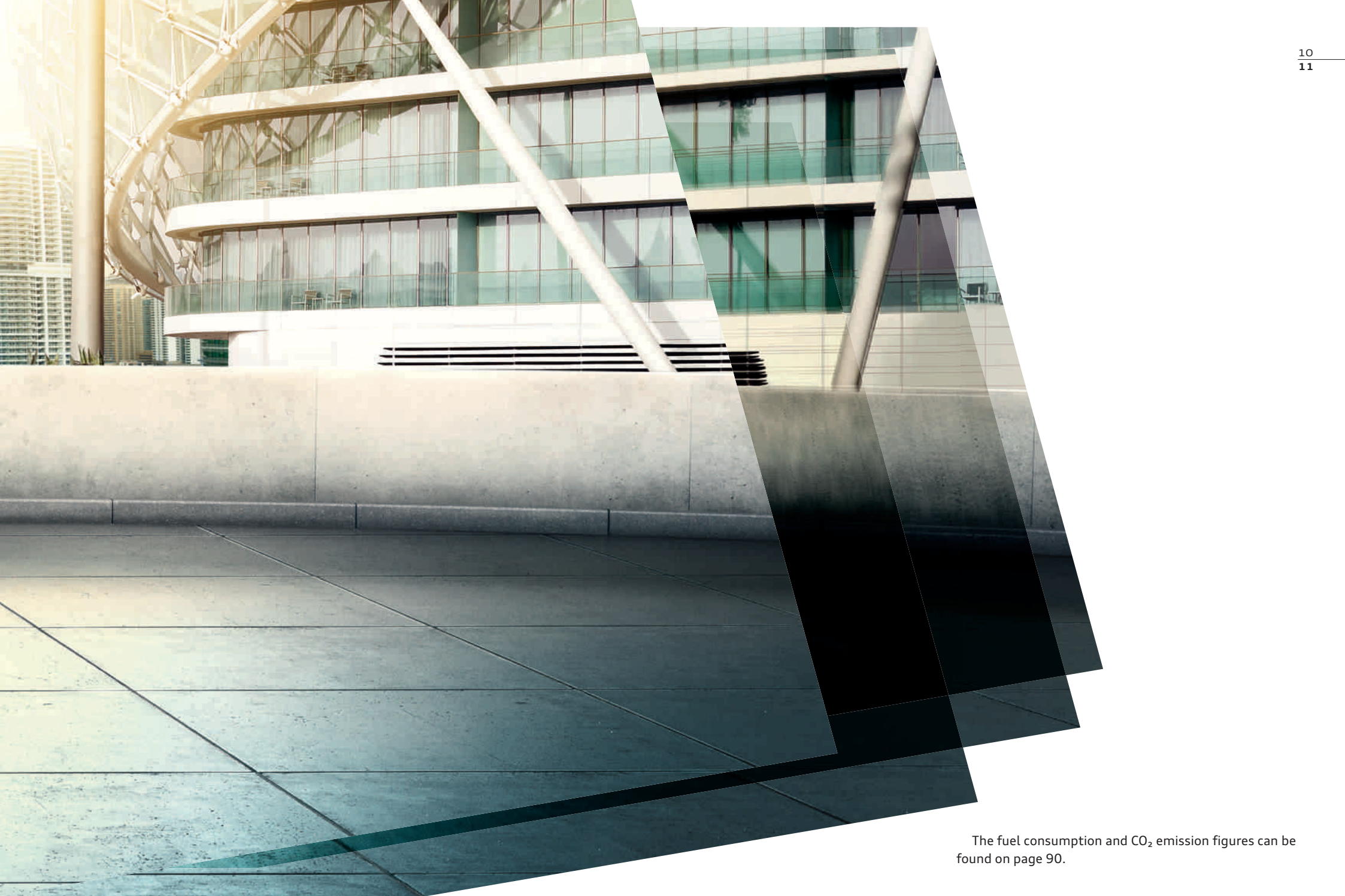

The fuel consumption and CO₂ emission figures can be found on page 90.



**Self-confidence has found its shape.
Now you're ready for anything.**



The fuel consumption and CO₂ emission figures can be found on page 90.

Pushing to the limit always keeps you ahead.

Dynamism that makes its mark. Created by powerful, efficient TFSI and TDI engines. Up to 245 kW. And up to 600 Nm. Generously designed for engine power and power delivery. Fuel consumption and emissions kept in check. High-level performance that adapts itself to your personal driving style. Thanks to the 8-speed tiptronic and Audi drive select. From efficient in “efficiency” mode to very sporty in “dynamic” mode. With improved cornering on fast roads. With optional all-wheel steering. So that you can extend your lead on any road.

The fuel consumption and CO₂ emission figures can be found on page 90.









quattro®. Driving confidence in every situation.

35 years of quattro. A never-ending success story. And one whose next thrilling chapter is set to impress. In the new Audi Q7. With the tried-and tested quattro drive. Increased traction comes as standard. For excellent driving dynamics. Permanently. Underpinned by the new Audi drive select modes, such as “offroad”. Making impressive use of all this car has to offer.

The fuel consumption and CO₂ emission figures can be found on page 90.





Seeing further will also get you further ahead.

Shedding light on the future. With optional Audi Matrix LED headlights. Their crystalline shine ensures bright, homogeneous illumination of the road. Clarity right down the line. Thanks to high-precision, individually controlled light-emitting diodes. Making a visible impression. LED rear lights are also standard. Plus optional dynamic indicators at the rear. Safety and comfort shine in a new light.





Comfort on a higher level.

The interior concept of the new Audi Q7: space to unleash your ideas. Take the seats, for example. Choose from a wide selection of high-quality materials, colours and functions.

The fuel consumption and CO₂ emission figures can be found on page 90.



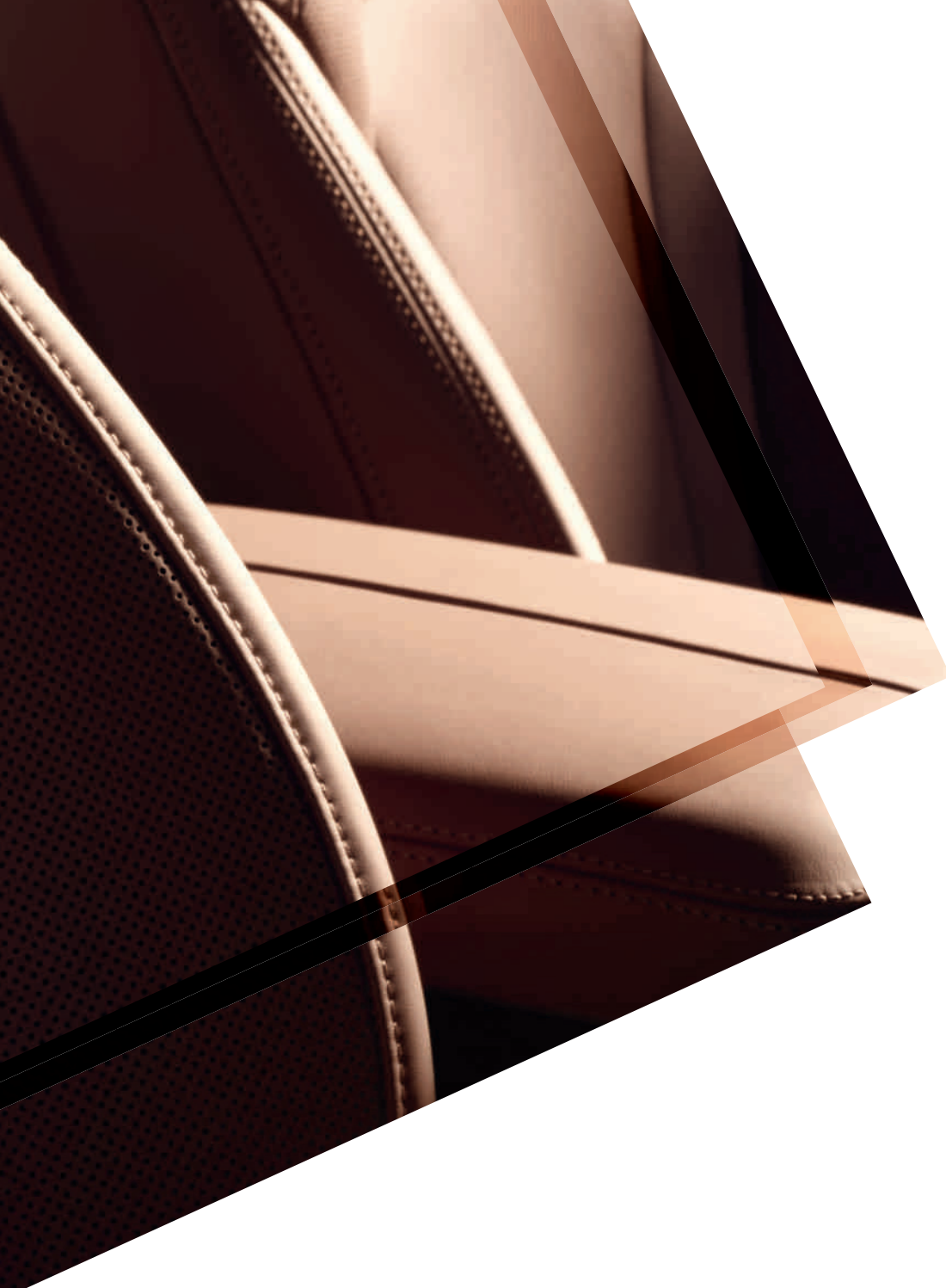

Premium quality, excellent workmanship. Seen and felt in the high-quality Valcona leather upholstery. Elegant atmosphere included. Double inlays for various customised application combinations. Just as you like it. You can also tailor the automatic air conditioning to your wishes. And, if you want, those of your passengers. Optionally available with up to four individually adjustable climate zones.



900 km
watching

Purple Rain In The...

Eichstätt

Adelschlag

Hitzhofen

Buxheim

Gaimersheim

Stammham

Bettbrunn

Mindelstetten

Kösching

Pleiling

Ingolstadt

Gerolfing

Erweil

Vohbrunn

Donau

Donaustausee

B13

+5,0°C

16:14

2,5km

1/min x 1000

P
OFF

0
km/h

You only thought you'd seen everything.

The future of mobility is right here. It's plain to see from the driver seat. With the optional Audi virtual cockpit. The fully digital instrument cluster with high-resolution 12.3-inch display. A host of information the driver needs clearly in sight. Razor-sharp, brilliant and rich in contrast. With MMI navigation plus with MMI touch on request. Additional 8.3-inch display area with the extending MMI display. Intuitive operation included. Thanks to the intelligent new MMI control concept. Fewer buttons, more functions. Vehicle settings, navigation, telephone, Audi connect and media. An even larger touchpad for even easier operation. Using the complex technology then becomes child's play. So you can relax and focus on discovering new destinations.

The fuel consumption and CO₂ emission figures can be found on page 90.



Flexibility creates new space.

Space redefined. Or simply taken literally. Made possible by a seat and loading concept that concentrates solely on what's essential. You. With a generous feeling of space. And many different configuration options. For the right number of seats and amount of luggage at any given time. With a comfortable bench seat as a second row. Optionally including separately adjustable seats for flexible volume in the luggage compartment. And a third row of seats on request. With two individual seats and electrically folded and raised backrests. Easy entry comes as standard. The new Audi Q7. With two, three, four, five, six or seven seats. And up to six child seats. Row upon row of good ideas for your flexibility.



The fuel consumption and CO₂ emission figures can be found on page 90.





The fuel consumption and CO₂ emission figures can be found on page 90.



Leaving virtually no trace allows you to make your mark.

The new Audi Q7 makes its mark in many ways. Trend-setting design. Thrilling performance. Innovative technologies. And needs an exclamation mark when it comes to lightweight construction. Up to 325 kg weight reduction compared to its predecessor. Achieved through progressive ideas and an intelligent mix of materials. For even better driving dynamics, increased efficiency and CO₂ values that are exemplary in this class.



Simplicity

Vorsprung simplifies.



Performance

Vorsprung accelerates.

quattro®

Vorsprung is superb.



Audi connect

Vorsprung connects.



Audi ultra

Vorsprung is sustainable.



Lighting technologies

Vorsprung is pioneering.

Vorsprung

durch Technik.



Assistance systems

Vorsprung means safety.

Audi takes you further.

The world is constantly changing. Technology is advancing at an ever faster pace. And in the process, more and more opportunities are opening up to you – nowhere more so than in the field of mobility. We are playing an instrumental role in shaping this progress. With a constant stream of new innovations. Striving to provide you with vehicles that enrich your life – and to help you get ahead in your mobile life.



Audi connect | Vorsprung connects.

Stay in touch with the world even when you're on the road.

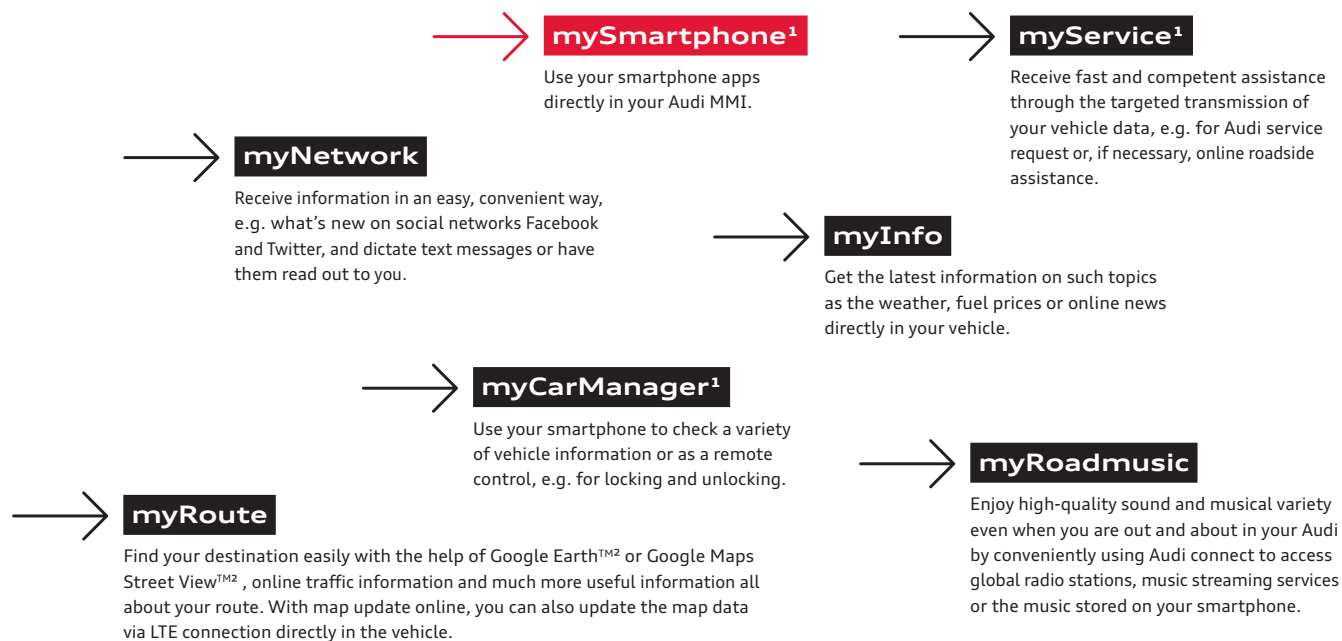

We live in a time of limitless possibilities. The optional Audi connect enables you to make the most of many of them in digital form directly from your Audi. At the push of a button. And now, with LTE, up to 10 times faster than with the previous UMTS standard. Thanks to myAudi and the services supported by Audi connect in your vehicle. Conveniently search for special destinations of your choice in the MMI or check the latest news, weather forecasts or your e-mails. Or use your laptop, tablet or other mobile devices via the Wi-Fi hotspot. All over the world. Intuitively, easily and conveniently.

The model-specific Audi connect services, legal information and notes on use can be found from page 77 onwards.

¹For information on when this feature will be available, please contact your Audi partner. ²Google and the Google logo are registered trademarks of Google Inc.

Simplexity | Vorsprung simplifies.

**Never lose
sight of the
big picture.**

Streamlined. Clearly arranged. Logical. The world of mobile infotainment: with the Audi Multi Media Interface (MMI) and many other controls that allow you to easily negotiate in the cockpit without losing sight of what's happening on the road. Together, they make phoning, navigating or surfing the internet via Audi connect highly intuitive, highly functional and highly convenient - not least thanks to a wide range of equipment options, such as the voice control system, head-up display, Audi virtual cockpit or Audi phone box with wireless charging. Experience how easy and intuitive equipment can be to operate.

Audi tablet*

provides a range of fully integrated and networked entertainment options and can be used in the rear of the vehicle and even outside it.

Head-up display

projects information such as the latest valid traffic signs or warnings, e.g. about a wild animal detected by the night vision assistant (if ordered), onto the windscreen and therefore into the driver's direct field of vision.

Voice control system

allows you to use everyday language to control many essential functions of the car phone, radio, CD player, DVD changer, TV tuner and the navigation system.

Audi virtual cockpit

Control a host of functions and MMI services displayed within your field of vision. You also have the choice between the 2 display variants classical and progressive, which show a wealth of information the driver needs in brilliant image resolution.

Multifunction leather steering wheel

including shift paddles. Allows you to control many functions, including the driver information system, without moving your hands from the steering wheel.

Audi MMI®

increases driving comfort with an intuitive control and display system for infotainment and vehicle functions, including inter-device MMI search by entering free text.

Audi phone box with wireless charging*

allows phone calls to be made in the vehicle with improved reception quality and integrated charging by placing the mobile phone in the compartment in the centre console.



Lighting technologies | Vorsprung is pioneering.

See and be seen better.

Darkness is relative. The optional Audi Matrix LED headlights virtually turn night into day. State-of-the-art, pioneering lighting technology for excellent and intelligent illumination of the road. For increased visibility. And to attract attention. But Audi Matrix LED headlights won't thrill you only at night. They're a spectacle during the day, too.



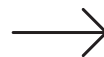

Audi Matrix LED headlights

are controlled by a camera and software to suit the course of the road and the position of other road users, illuminating the given scene using innovatively configured, dimmable LEDs in near-daylight colour. For even more safety on the road.

Assistance systems | Vorsprung means safety.

Relax

even before

you get there.

Each drive is different. Yet they all have one thing in common – the feeling of being protected that you get from every Audi. Many optional driver assistance systems in your new Audi Q7 help you during your journey and guarantee even greater comfort while you're on the road. Get to know the most important driver assistance systems.



Parking

simplifies parking and manoeuvring with the parking system, park assist and cameras.

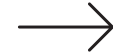

City

increases safety and comfort in city traffic through interconnected assistance systems, e.g. when changing lanes, when reversing with cross traffic or when exiting the vehicle, and can in certain situations minimise the risk of accidents with other road users.

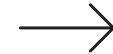

Tour

assists the driver through sensor-controlled assistance systems geared to improving safety, comfort and efficiency, especially on motorways and country roads, which helps drivers stay alert.

Parking system, rear
Parking system plus



Programmable speed limiter

Audi pre sense basic
Audi pre sense city
Audi pre sense front
Audi pre sense rear



Hill hold assist and
hill descent control

Hold assist
Turning assistant

Intersection assistant
Exit warning

Cruise control

Audi side assist
Night vision assistant
High-beam assist

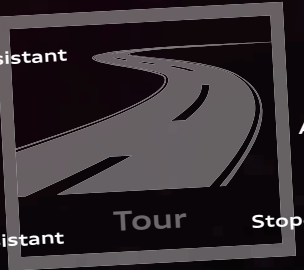

adaptive cruise control
Congestion assistant
Predictive efficiency assistant

Audi active lane assist
Stop&Go function
Avoidance assistant

quattro®

quattro®





quattro® | Vorsprung is superb.

**All conditions are
perfect conditions.**

Have the road completely under control, thanks to permanent distribution of the drive force to all four wheels. The rear axle is variably controlled via a self-locking centre differential. Always as the situation demands, always selective. Experience handling stability, dynamism and agility as never before and combat the effects of over- and understeer with quattro. For increased traction and superior propulsive power. Tame any road. And always keep your eyes set on where you're heading. In bends. On straights. On nearly any surface. For a fascinating experience that sticks. To the road – and in your mind.

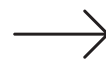

Wheel-selective torque control

improves driving stability during fast cornering.

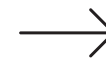

Centre differential

distributes the drive force between the axles as needed.



Performance | Vorsprung accelerates.

Get the most out of every drive.

Get in. Buckle up. Start the engine. Wherever you're heading, enthralling driving dynamics will power you there. For as you know, the world is your oyster once you get behind the wheel of your Audi Q7. You decide the direction. The driving style. The pace. With higher power and lower fuel consumption. And enjoy the satisfaction of knowing you have plenty in reserve. More than enough to get the very best from every drive.

→ **TFSI®**

Audi TFSI engines attain a particularly high compression rate. The result: outstanding efficiency combined with optimum performance. Substituting supercharging for cubic capacity has the effect of considerably reducing engine size and weight – while performance remains as impressively dynamic as ever. For power delivery that will win you over from the word go.

→ **TDI®**

With their combination of direct injection and turbocharging, Audi TDI engines promise exceptional performance thanks to their high torque output over the entire engine speed range with constant power build-up. They are renowned for being fuel-efficient and for reducing emissions. But they are incredibly dynamic too, letting you get the maximum out of any road.

→ **Audi drive select**

The standard Audi drive select lets you adjust the driving characteristics of the new Audi Q7 to suit your requirements. At the push of a button. Sportier, more comfortable, more balanced, more economical or even tailored to your requirements – you decide.

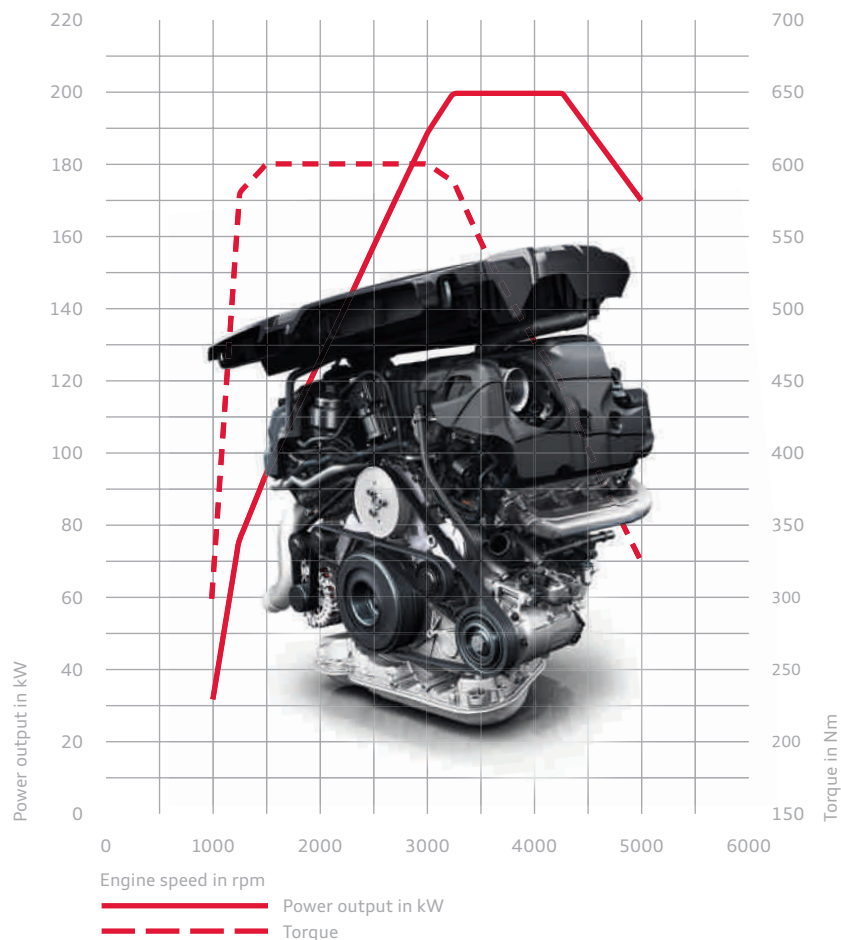

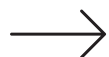
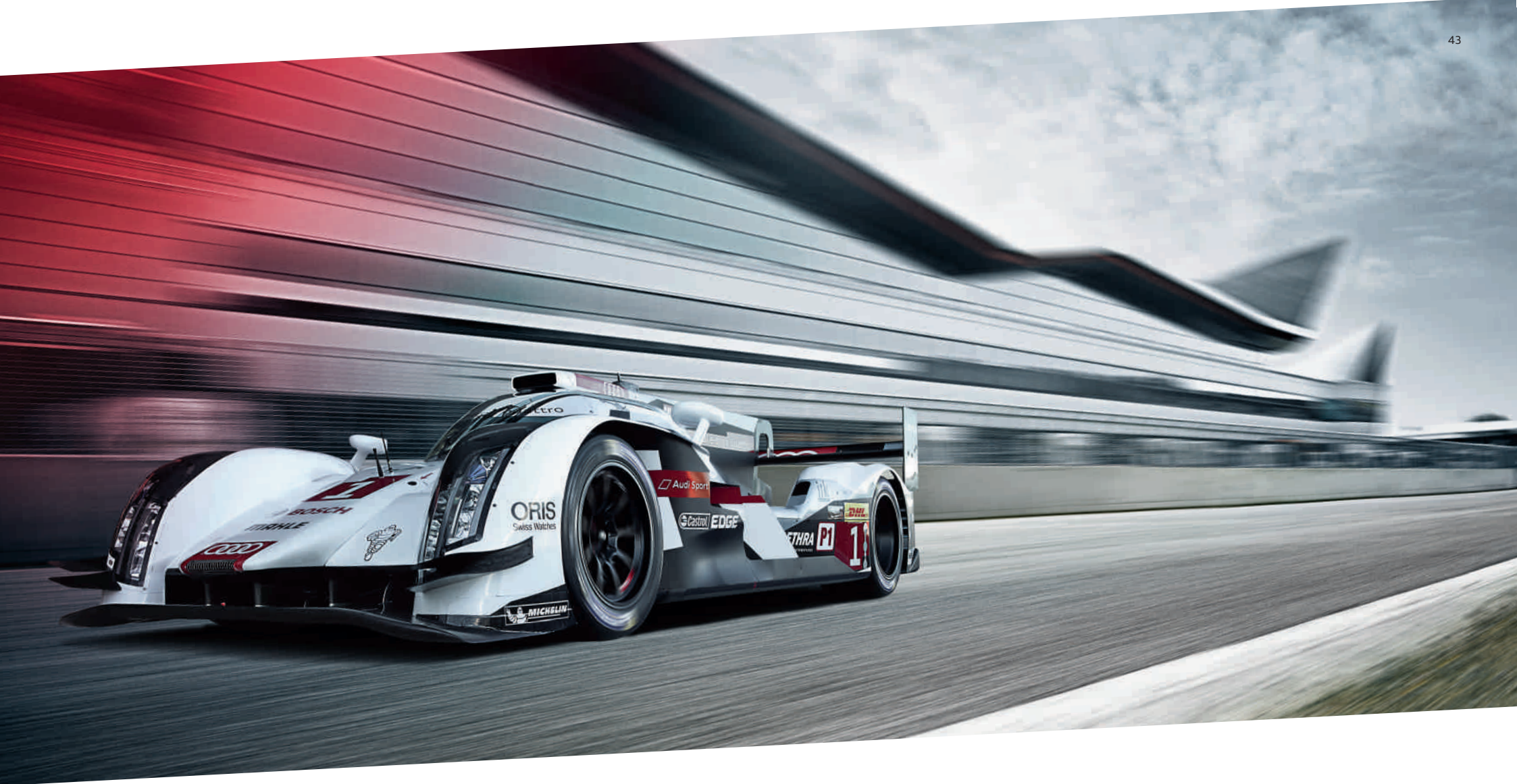

adaptive air suspension

The optional electronically controlled air suspension including tilt angle display acts separately on each of the 4 wheels, providing for balanced handling characteristics even with a heavy load. Also available as a sport version with even stiffer damping.

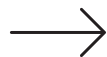

All-wheel steering

The optional all-wheel steering considerably reduces the turning circle when driving slowly. When driving fast, it helps to increase the driving dynamics.

ultra

Building an Audi is an extremely complicated business. And yet a simple principle applies for all models: all vehicle components interlock precisely in order to produce emission-reducing synergies. What started in accordance with this principle at the end of the 1980s with Audi lightweight construction and the revolutionary Audi Space Frame (ASF®) is now known as the reversal of the weight spiral: every lightweight component has an impact on other components, which can in turn be made smaller. In this way, existing forms and materials are continuously being improved with regard to their functionality,

the lowest possible weight and their production process. With the goal of building vehicles that are even more efficient and make more sparing use of resources. At the same time, more and more efficiency technologies are being built into an Audi. These include recuperation and the start-stop system. Not to mention progressive, efficient high-tech engines. For greater driving dynamics, high compression, more efficient combustion and lower CO₂ emissions. All this is known as Audi ultra. Today and in the future – towards CO₂-reduced mobility.

Lightweight expertise

Less weight. More savings, power and endurance. Audi lightweight technology. What started with lightweight body construction has now made its way into nearly all areas, combining innovative materials such as aluminium, carbon and magnesium, intelligent design principles and resource-saving manufacturing processes into an overall concept.

Aerodynamics

Less drag, more efficiency. Thanks to the consistently aerodynamic styling of the vehicle's lines, its underbody and spoiler edges – in order to achieve the best possible form for aerodynamic efficiency. Not forgetting tyres with reduced rolling resistance. All tested in the Audi wind tunnel at up to 300 km/h.

Engine expertise

Powerfully and efficiently driven. By Audi ultra with efficiency technologies in the engine sector. For example, with the efficient thermal management, which lowers the energy consumption of the engine, or with Audi TDI clean diesel technology, which can be used to reduce emissions.

Audi ultra | Vorsprung is sustainable.

The sum of our most efficient ideas.

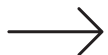

Recuperation

Braking that leads to even more efficient driving. With brake energy recovery (recuperation). Part of the kinetic energy produced when braking and coasting is temporarily stored in the vehicle's battery and then used when accelerating. Depending on the driving cycle, this can save up to 3% of fuel.

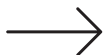

Transmission expertise

Improved efficiency thanks to improved transmission ratios. A higher torque output makes longer ratios possible, especially in higher gears. For powerful torque in the low engine speed range which reduces fuel consumption, yet has no adverse effects on driving performance and sportiness.







As unique as you are. The equipment options.

Sportiness, comfort, design, functionality – whatever you demand of your Audi, it offers you a wealth of custom options. Audi equipment versions are varied and high-quality and you can tailor them entirely to your needs.

Character takes on many forms. Here are two of them.

What makes an Audi your Audi? Vehicle equipment entirely tailored to your needs. There is a wide range of options available to you for giving your vehicle the exact touch you have in mind. More sportiness? More elegance? Let us inspire you.

Audi Q7 in graphite grey, metallic

LED headlights

Paint finish in graphite grey, metallic (front and rear bumper bottom section, sill trims and wheel arch trims grained in anthracite, door trim strips with quattro embossing and underbody protection, front and rear, in Barcelonetta silver)

Cast aluminium wheels in 10-spoke star design, contrasting grey, partly polished*

Sport seats in Alcantara/leather, black

Upper inlay in brushed aluminium, Sono, and lower inlay in oak, grey



The fuel consumption and CO₂ emission figures can be found on page 90.



**Audi Q7
in Argus brown, metallic**

Full paint finish in Argus brown, metallic

Forged aluminium wheels in 5-arm turbine design,
contrasting grey, partly polished*

Customised contour seats in Valcona leather,
pistachio beige

Upper inlay in high gloss black and lower inlay
in Beaufort walnut



*Please note the special information relating to wheels on page 91.

The right driving force for every personality.

No matter which Audi engine you choose, they all have high compression ratios, highly efficient combustion and outstanding efficiency. In short, they deliver more power whilst using less fuel and producing fewer emissions.





3.0 TFSI quattro

TFSI®

The Audi TFSI engines offer outstanding efficiency and improved performance whilst at the same time retaining their dynamism. The 3.0 TFSI quattro in the new Audi Q7, for example, has a power output of 245 kW, enabling the car to accelerate from 0 to 100 km/h in 6.1 seconds and reach a top speed of 250 km/h.*



3.0 TDI quattro

TDI®

Audi TDI engines: high torque output over the entire engine speed range – with constant power build-up. They are renowned for being fuel-efficient and for reducing emissions. The 3.0 TDI quattro, for example, has a power output of 200 kW, a top speed of 234 km/h and accelerates from 0 to 100 km/h in 6.3 seconds.*

Remaining faithful to the sporty line: the S line packages.



The S line packages emphasise the sporty character of your Audi Q7. Accentuate the dynamic body line, lend the interior even more expression or give the suspension even sportier definition for enhanced driving dynamics. And make a true athlete of your Audi.

S line exterior package

Front and rear bumpers, door trim strips, side radiator grilles and diffuser insert in a striking, sporty design

Front and rear bottom bumper sections, door trim strips and wheel arch trims painted in body colour

Diffuser insert in platinum grey, insert with honeycomb grid in black

S line roof edge spoiler

Loading sill protector in stainless steel

Headlight cleaning system

Door sill trims with S line logo

S line emblem on the front wings



The illustrations show forged aluminium wheels in 5-arm turbine design, contrasting grey, partly polished.

S line sport package

The following range of equipment is included in the S line sport package:

Cast aluminium wheels in 5-parallel-spoke design
size 9 J x 20 with 285/45 R 20 tyres¹

adaptive air suspension – sport

Door sill trims
with S line logo

S line emblem
on the front wings

Interior, dashboard and headlining
in black, contrasting stitching on seat upholstery;
sport leather steering wheel, leather-covered centre
armrest, floor mats and door armrest (if ordered)

Sport seats, front
electrically adjustable, including electrically adjustable
4-way lumbar support

S line seat upholstery
in perforated Alcantara/leather in black with S
embossing in the front-seat backrests

**S line sport leather steering wheel in 3-spoke design
with multifunction plus and shift paddles**
in black leather (steering wheel grips in perforated leather)
and with S line emblem

Selector lever
in perforated black leather

Upper inlay
in brushed aluminium, Sono

Lower inlay
in chrome paint finish, slate grey

Loading sill protector
in stainless steel

Optionally available:

Further 20-inch (or larger) wheels

**S line seat upholstery in Valcona leather,
in black or rotor grey**
with S embossing in the front-seat backrests

Upper inlay
in brushed aluminium, Sono

Lower inlay
oak, grey

**S line sport leather steering wheel in 3-spoke design
with multifunction plus and shift paddles, heated,
or S line sport contour leather steering wheel in
3-spoke design, flattened at the bottom, with
multifunction plus and shift paddles**
each in black and with S line emblem, steering wheel
grips in perforated leather

**Paint finish in all standard/optional equipment colours
and additionally the special colour Daytona grey, pearl
effect**

The fuel consumption and CO₂ emission figures can be found on page 90.

¹You will find specifications on the technical characteristics of tyres on page 91. ²Please note the special information relating to wheels on page 91.

As unmistakable as your own standards: the Audi design selection.

The Audi design selection offers you an aesthetic pre-selection of special materials and colours for the interior. The fine leather upholstery and trim in the colour Murillo brown with attractive contrasting stitching gives the interior an exclusive ambience.



The fuel consumption and CO₂ emission figures can be found on page 90.

Audi design selection Murillo brown

The Audi design selection Murillo brown includes the following equipment items:

- Customised contour seats in Valcona leather, Murillo brown with contrasting stitching in granite grey; with seat heating, front, and seat ventilation
- Headlining, upper pillar trim and double sun visors in Alcantara, lunar silver
- Inner door trim panel in Alcantara, Murillo brown
- Upper instrument panel and door rails in leather, granite grey, with lock seams in Murillo brown
- Instrument panel underside in leather, Murillo brown
- Centre console, armrest in the door and comfort centre armrest with fore/aft adjustment in leather, Murillo brown, with lock seams in granite grey
- Backrest covers on front seats in leather, Murillo brown
- Sport leather steering wheel in 3-spoke design with multifunction plus and shift paddles including steering wheel heating in leather, granite grey, with contrasting stitching in Murillo brown
- Upper inlay in brushed aluminium, Sono, lower inlay in sycamore, natural dark brown
- Centre console in sycamore, natural dark brown, and brushed aluminium, Sono
- Manual sunblinds for the rear window and the rear door windows
- Floor mats in luxury velours, granite grey
- Aluminium “design selection” badge in the doors
- Full-leather package with the following range of leather-covered equipment: armrests in the doors, lower door trim and door rail, centre console, underside of instrument panel including the glove compartment, top side of instrument panel and seat trim in the front seats



You have an exclusive character. So why shouldn't your Audi have one too?

That the Audi exclusive range aspires to exclusivity is already evident from its name. Selected décors and coloured leather can be combined with customised paint finishes from the large selection of Audi exclusive colours to suit your own personal preferences. So you can highlight your car's exceptional character to even better advantage. Your Audi partner and the Audi exclusive Studio of the Audi Forum Neckarsulm await your wishes.



If you want to find out more about the Audi exclusive equipment versions and quality standards, just scan this QR code using your smartphone. Or follow this link in your browser: www.audi.com/exclusivefilm





Audi Q7 with Audi exclusive customised paint finish in Nardo grey

Audi Sport cast aluminium wheels in 5-twin-spoke design*

Leather upholstery and trim in Audi exclusive Valcona leather with customised contour seats in alabaster white with head restraints, seat side bolsters and contrasting stitching in jet grey

Audi exclusive leather controls in jet grey with contrasting stitching in alabaster white

Door trim inserts (in Alcantara), door pull handles including armrests, centre armrest and centre console trim and underside of instrument panel and lower door trim in Valcona leather, alabaster white, with contrasting stitching in jet grey; top side of instrument panel and door rails in Valcona leather, jet grey, with stitching in jet grey

Upper inlay in brushed aluminium, Sono, and lower inlay in aluminium/Beaufort wood, black

Audi exclusive carpet and floor mats in jet grey with leather piping and stitching in alabaster white



| Solid paint finishes



Carrara white

| Metallic paint finishes

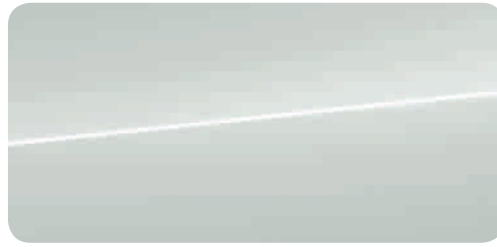

Glacier white, metallic

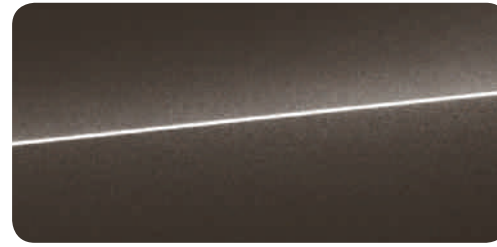

Argus brown, metallic

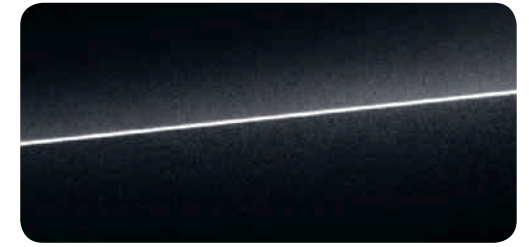

Orca black, metallic

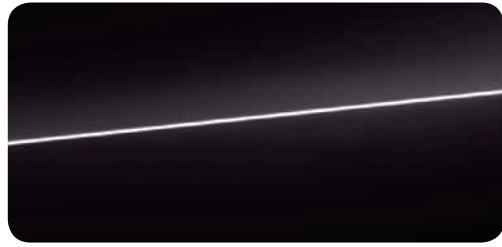

Night black

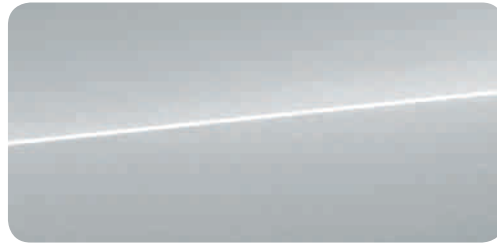

Floret silver, metallic

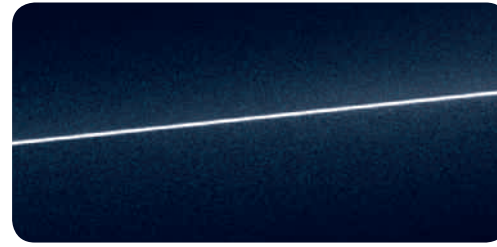

Ink blue, metallic

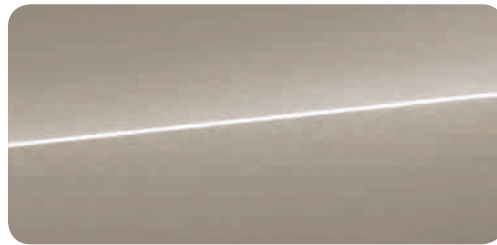

Diamond beige, metallic

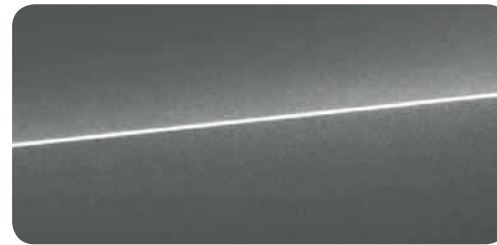

Graphite grey, metallic

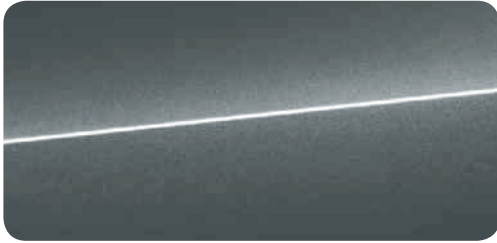
| Pearl effect paint finish**Daytona grey, pearl effect****| Customised paint finishes****Audi exclusive customised paint finishes**
From quattro GmbH**Solid/metallic/pearl effect paint finishes**

Front and rear bottom bumper section and sill trims and wheel arch trims grained in anthracite, door trim strips with quattro embossing and underbody protection, front and rear, in Barcelonetta silver

Full paint finish

Front and rear bottom bumper section and sill trims and wheel arch trims in full paint finish, door trim strips with quattro embossing and underbody protection, front and rear, in Barcelonetta silver

| Summer wheels



Cast aluminium wheels
in 10-spoke design
size 8 J x 18 with 235/65 R 18 tyres¹



Cast aluminium wheels
in 5-spoke star design
size 8.5 J x 19 with 255/55 R 19 tyres¹



Cast aluminium wheels
in 5-parallel-spoke design (S design)
size 9 J x 20 with 285/45 R 20 tyres¹



Forged aluminium wheels
in 5-arm turbine, contrasting grey,
partly polished²
size 9.5 J x 21 with 285/40 R 21 tyres¹



Forged aluminium wheels
in 5-arm design
size 8 J x 18 with 255/60 R 18 tyres¹



Audi Sport cast aluminium wheels
in 7-twin-spoke design with RS logo^{3,4}
size 8.5 J x 19 with 255/55 R 19 tyres¹



Audi Sport cast aluminium wheels
in 10-Y-spoke design^{3,4}
size 9 J x 20 with 285/45 R 20 tyres¹



Audi Sport cast aluminium wheels
in 5-twin-spoke design with RS logo³
size 9.5 J x 21 with 285/40 R 21 tyres¹



Cast aluminium wheels
in 5-V-spoke design
size 8.5 J x 19 with 255/55 R 19 tyres¹



Cast aluminium wheels
in 10-spoke star design, contrasting grey,
partly polished²
size 9 J x 20 with 285/45 R 20 tyres¹



Audi Sport cast aluminium wheels
in 5-arm offroad design, matt titanium look,
gloss turned finish^{2,3,4}
size 9 J x 20 with 285/45 R 20 tyres¹



Audi Sport cast aluminium wheels
in 5-twin-spoke design, matt titanium look,
gloss turned finish with RS logo^{2,3,4}
size 9.5 J x 21 with 285/40 R 21 tyres¹

| Winter wheels**Forged aluminium winter wheels
in 5-arm design**

size 8 J x 18 with 255/60 R 18 tyres¹, can be fitted with snow chains, permissible top speed 210 km/h

**Cast aluminium winter wheels
in 5-parallel-spoke design (S design)**

size 8 J x 20 with 255/50 R 20 tyres¹, can be fitted with snow chains, permissible top speed 210 km/h

Tyre pressure monitoring system

Sensors monitor the air pressure set in the tyres throughout the journey; also works with winter wheels delivered by Audi. Visual and acoustic warning if the pressure drops in one or more tyres; display in the driver information system and the MMI. Air pressures and temperatures of the individual tyres are displayed in the MMI system whilst driving.

**Cast aluminium winter wheels
in 5-spoke star design**

size 8 J x 19 with 255/55 R 19 tyres¹, can be fitted with snow chains, permissible top speed 210 km/h

**Cast aluminium winter wheels
in 10-spoke star design**

size 9 J x 20 with 285/45 R 20 tyres¹, cannot be fitted with snow chains, permissible top speed 240 km/h

¹You will find specifications on the technical characteristics of tyres on page 91. ²Please note the special information relating to wheels on page 91. ³From quattro GmbH.

⁴For information on when this feature will be available, please contact your Audi partner.

Premium quality you can rely on.

You have a special place in your Audi. Exclusive comfort can be felt on the front and rear seats: thanks to high-quality materials and first-class workmanship. Whether you decide on standard seats with cloth or leather upholstery or sport seats or customised contour seats with stable lateral support for dynamic driving: you're sitting in the right place.



Standard seats, front 1

The illustration shows standard seat, front, in cricket leather, rock grey.

Standard seats, front, with seat ventilation 2

The illustration shows standard seat, front, in perforated cricket leather, rock grey, with seat ventilation.



Sport seats, front 3

The illustration shows sport seat, front, in Alcantara/leather, black.

*For cloth seats, manually adjustable.



Customised contour seats 4

The illustration shows customised contour seat, front, in perforated Valcona leather, rock grey.

| Seating comfort

Front seats, electrically adjustable, including memory function for the driver seat
with electric adjustment of seat height, fore/aft position, seat and backrest angle as well as electric 4-way lumbar support; 2 pre-sets for the electrically adjustable driver seat, the exterior mirrors and the electric steering wheel adjustment (if ordered)

Front seats, electrically adjustable, including memory function for the 2 front seats

Comfort centre armrest, front
with fold-open storage compartment, fore/aft position can be adjusted separately for driver and front passenger

Seat ventilation, front

active seat ventilation of the seat and backrest centre panel and the thigh support of the driver and front-passenger seat; using a fan on standard seats or by drawing in air on customised contour seats, the system ensures a pleasant seating climate even at high outside temperatures; adjustable in 3 stages directly from the air conditioning controls; automatic heating by seat heating to prevent cold seats. With seat ventilation, the leather of the ventilated front seats and non-ventilated outer rear seats is perforated.

Seat ventilation and massage function, front

seat ventilation plus muscle massage using 10 pneumatic cushions; 5 different programs (Wave, Tapping, Stretch, Back, Shoulder), each offering 5 levels of intensity; can be selected via multifunction switches on the customised contour seat or via MMI

Seat heating, front

separate temperature setting for each seat, fast activation regardless of engine operating temperature, an especially relaxed ride in the cold weather; heats the seat and backrest centre panel and the seat side bolsters; can be individually adjusted in multiple stages for the driver and front-passenger seats via a direct selection button on the air conditioning controls; separate control of seat cushion and seat backrest adjustable in the MMI car menu

Seat heating, front and rear

Same equipment as for front seat heating, also for the outer rear seats of the 2nd row, can be regulated separately

The model-specific standard and optional equipment can be found in the index from page 94 onwards.

| Seats in the rear



Centre armrest, rear
in the rear seat backrest, foldable, including 2 cup holders



Rear seat backrest, split-folding
rear seat backrest, can be split-folded 35 : 30 : 35 or completely, including 35 : 30 : 35 backrest angle adjustment and ISOFIX child seat mounting and Top Tether for all 3 seats, with leather upholstery and trim: including rear centre armrest with 2 cup holders



Rear seat bench plus
seats of the 2nd row allow individual manual adjustment of fore/aft position at a ratio of 35 : 30 : 35 as well as the backrest angle. The 3 seats of the rear seat bench can be folded down 35 : 30 : 35 (level loading floor) The 2 outer seats include additional double-folding mechanism. Rear centre armrest with 2 cup holders; including ISOFIX child seat mounting and Top Tether for all 3 seats



3rd row of seats
in addition to rear seat bench plus: 3rd row with 2 seats in the rear with 2 additional ISOFIX child seat mountings with Top Tether, can be split and electrically folded down flat to create a level loading floor; with improved convenience entry (double-folding mechanism) for the 2nd row; electrical folding function accessible from the luggage compartment or in the entrance area of the 2nd row; including belt force limiters and therefore Group III child seat approval (Europe only)

| Headlinings

Headlining in cloth, black
and attachments in black

Headlining in Alcantara
and attachments in Alcantara including double sun visors, coordinated with the interior colour

Headlining in Alcantara, black
and attachments in Alcantara, black including double sun visors

| Leather



Valcona leather, black

3



Valcona leather, cedar brown

3

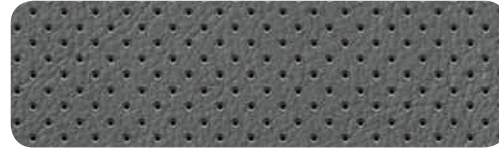

Perforated Valcona leather, rock grey

4



Perforated Valcona leather, Murillo brown with contrasting stitching in granite grey

4



Perforated Valcona leather, black

4

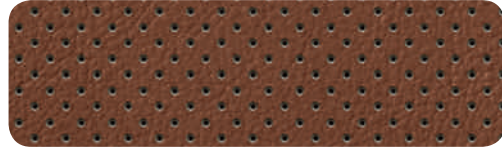

Perforated Valcona leather, cedar brown

4



Valcona leather, rotor grey with contrasting stitching

3



Valcona leather, black with contrasting stitching

3

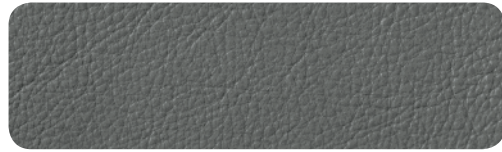

Valcona leather, rock grey

3

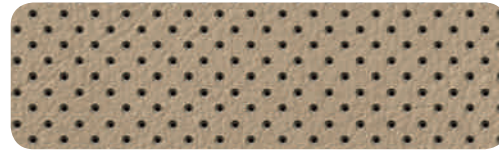

Perforated Valcona leather, pistachio beige

4



Audi exclusive leather upholstery and trim*
Individual choice of colour for leather/stitching

3

4

| Seat options

- 1 Standard seats, front
- 2 Standard seats, front, with seat ventilation
- 3 Sport seats, front
- 4 Customised contour seats, front

| Upper inlays



High gloss black

| Lower inlays

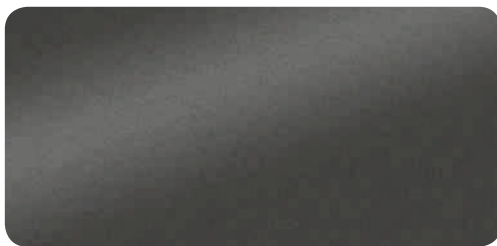

Anodysed paint finish, anthracite

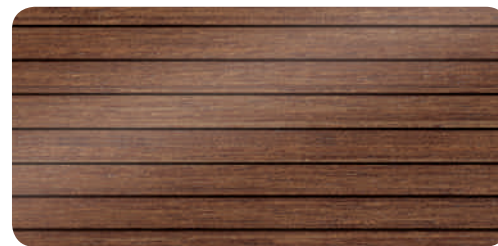

Beaufort walnut



Diamond paint finish, silver grey



Walnut, terra brown

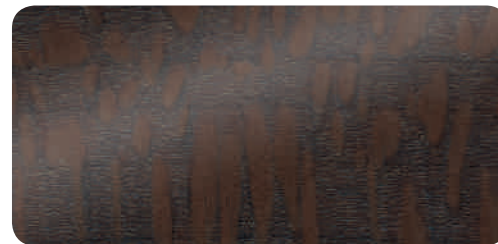

Sycamore, natural dark brown



Brushed aluminium, Sono

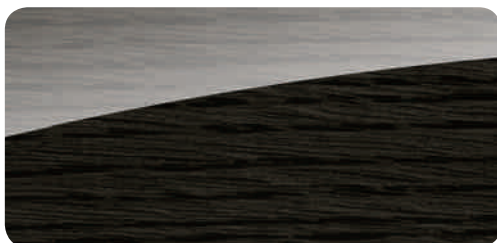

Oak, grey

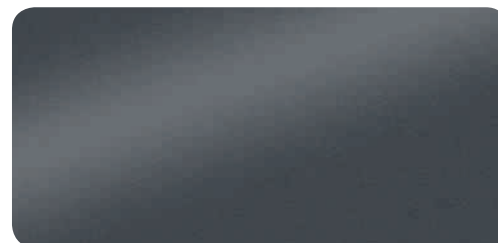

Chrome paint finish, slate grey

| Audi exclusive lower inlays



Modrone, gold



Fine grain ash, nougat



Aluminium/Beaufort wood, black

Upper inlay

inlays in diamond paint finish, silver grey, high gloss black and brushed aluminium, Sono on the dashboard, door trims and in the centre console create an impressive contrast

Lower inlay

high-quality paint finish or wood inlays add exclusive touches to the dashboard, door trim and centre console



Tamo ash, natural dark brown

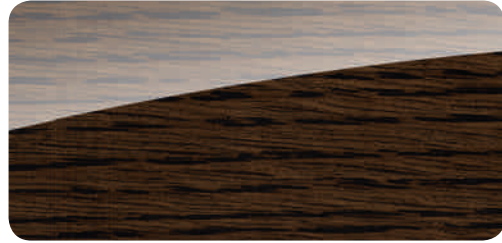

Oak, sepia



Piano finish, black



Vavona, bronze



Fine grain myrtle, nutmeg

| Headlights



Audi Matrix LED headlights

The innovative technology combines a camera system with LED light sources and precision optics for highly adaptive light distribution. The system blanks out light that would otherwise shine directly on oncoming vehicles or vehicles in front but continues to fully illuminate all the other areas in between and alongside. The front lighting thus adapts dynamically, providing the driver with a much wider visual range. The conventional division between dipped and high beam is dispensed with. Familiar convenience functions such as the static turning light, all-weather light, junction light, motorway light and travel mode, which uses GPS data to switch between right- and left-hand drive modes are integrated into the LED technology. The LEDs of the Audi Matrix LED headlights also perform the dynamic cornering light functions. Using data from the navigation system for assistance, the cornering light function starts responding shortly before the steering wheel is turned. The marking light cooperates with the optional night vision assistant. If pedestrians are detected, individual LEDs flash briefly 3 times in succession to mark out the pedestrians clearly from their surroundings. Distinctive features include the crisp lighting pattern of the LED daytime running lights. Including headlight cleaning system



LED headlights

allow precise, near-daylight illumination of the road; combining LED dipped beam, high beam, daytime running lights, motorway light, indicator and static turning light as well as all-weather light; including headlight cleaning system; motorway light that automatically increases headlight range from a speed of approximately 110km/h; all-weather light to reduce the risk of the driver being dazzled when visibility is poor; striking light pattern in day and night design configurations; low power consumption and long service life, including high-beam assist



Xenon plus

intensive road illumination, good uniformity and range thanks to headlights with durable gas discharge technology for dipped and high beam. The automatic headlight range control prevents oncoming traffic from being dazzled. The daytime running lights use LED technology with low power consumption.



LED rear lights

brake lights, tail lights, rear fog lights, indicators and rear number plate lights in low-energy LED technology; with reversing lights, third brake light in high-mounted roof edge spoiler; bumper light strip performs the rear light function when the luggage compartment lid is open

LED rear lights with dynamic indicator

same functions as the LED rear lights, but additionally feature a dynamic and quickly recognisable lighting pattern for the indicators. The segments of the LED light band are illuminated in turn within milliseconds, creating a pulse of light that runs outwards in the direction in which the car is turning. In conjunction with LED headlights and Audi Matrix LED headlights

High-beam assist

improves the driver's visibility and ensures a more relaxed drive thanks to the extra comfort and convenience. Depending on the traffic situation, the high beam is automatically switched on or off. Working within system limits, automatically detects the headlights of oncoming traffic, the rear lights of other road users and light sources in built-up areas. In conjunction with the optional night vision assistant, the networked vehicle functions support the marking light for detected pedestrians for more safety when driving at night.

Light/rain sensor

to control the automatic lights-on function and the automatic windscreen wiper function, including coming home/leaving home function: delayed switching-off/automatic switching-on of the main headlights, rear and number plate lights when parking/opening the vehicle

| Interior lighting

Interior lighting in LED technology

in the front and the rear and one for the optional 3rd row of seats, including capacitive reading lights in front, reflected lighting on centre console, vanity lights, front and rear footwell lighting, glove compartment light, front and rear entry lights, front and rear inside door handles, active door warning lights, luggage compartment lights to the right and left as well as courtesy lighting in the luggage compartment lid for easy loading and unloading



Lighting package

in addition to interior lighting: contour lighting for dashboard and front and rear door trim; with optional exit warning function; lighting of front and rear door pockets with capacitive activation (contactless light control); front and rear ambient door lighting; courtesy lighting in door handles

Ambient lighting

in addition to lighting package:

- ambient lighting for the centre console
- contour lighting for the centre console illuminated
- door sill trims, front/rear
- 3 predefined colour profiles; additional interactive, custom colour profile. The interactive colour profile is controlled via the Audi drive select modes. The colour adjustments are for the contour and ambient lighting features

| Exterior design



Audi Singleframe

radiator grill in dark grey, structured, matt; one-piece trim frame in aluminium around the radiator grille, with horizontal struts in aluminium; with Audi rings

Body

lightweight unitary body in multi-material design, front and rear areas feature defined crumple zones

Model name/logo

model/technology name on the luggage compartment lid, quattro logo in the radiator grille and the dashboard on the passenger side; on request also available without the model/technology name on the rear

Roof rails

for safe transportation of items; strong and aerodynamically shaped, in anodised aluminium

Roof rails, black

Exhaust tailpipes

dual-branch design, with rectangular trims

Gloss package

window slot trims in aluminium look, outer B- and C-pillar trim in gloss black

Audi exclusive black gloss package,^{1,2}

for black styling accents around the Audi Singleframe, the front bumper and the trim strips on the side windows

| Interior design



Audi exclusive carpet and floor mats^{1,2}

Choice of colour for the carpet, floor mats, leather piping and stitching from the Audi exclusive range of colours.

Audi exclusive floor mats¹

Choice of colour for floor mats, leather piping and stitching from the Audi exclusive range of colours.

| Steering wheels/controls



Leather steering wheel in 4-spoke design with multifunction plus and shift paddles

with 14 multifunction keys for conveniently operating the available infotainment features, such as audio skip, activation of the voice control system, NAV or freely programmable buttons; adjustable in height and reach; with full-size airbag; includes selector lever knob in leather; colour-coordinated with the selected dashboard top side

Leather steering wheel in 4-spoke design with multifunction plus and shift paddles including steering wheel heating

features as for leather steering wheel in 4-spoke design with multifunction plus and shift paddles



Sport leather steering wheel in 3-spoke design with multifunction plus and shift paddles

with 14 multifunction keys for conveniently operating the available infotainment features, such as audio skip, activation of the voice control system, NAV or freely programmable buttons; adjustable in height and reach; with full-size airbag; includes selector lever knob in leather; colour-coordinated with the selected dashboard top side

Sport leather steering wheel in 3-spoke design with multifunction plus and shift paddles including steering wheel heating

features as for sport leather steering wheel in 3-spoke design with multifunction plus and shift paddles



Sport contour leather steering wheel in 3-spoke design, flattened at the bottom, with multifunction plus and shift paddles

with more heavily contoured steering wheel rim; features as for sport leather steering wheel in 3-spoke design with multifunction plus and shift paddles

Electric steering wheel adjustment

adjustable in height and reach, with automatic entry and exit function

Selector lever knob in leather

colour-coordinated with the selected vehicle interior colour and to match the dashboard top side.

Audi exclusive leather controls¹

Leather-covered steering wheel rim, gear/selector lever knob and gear lever gaiter in Audi exclusive leather. Individual choice of colour for the leather and the stitching from the range of Audi exclusive colours. Stitching on the steering wheel rim with specific Audi exclusive seam detail

| Mirrors

Exterior mirrors with integrated LED indicator electrically adjustable, heated and folding, including automatic kerb-side function for the exterior mirror on the passenger side, convex, flat or aspherical mirror glass; body-coloured housing

also optionally:

with memory function

automatically dimming on both sides

automatically dimming with memory function on both sides

The automatic kerb-side function tilts the exterior mirror on the passenger side downwards when reverse gear is selected, giving the driver a better view of the kerb.

Interior mirror, manually dimming
in same colour as headlining

also optionally:

automatically dimming

| Roof system



Panoramic glass sunroof

2 sections, electrical activation to raise and open the front glass section; tinted glass insert and an electrically operated sunblind as well as convenience closing/opening via vehicle key; ensures a comfortable interior that is flooded with light; improved interior climate by means of efficient ventilation

| Glazing



Dark-tinted windows (privacy glazing)

dark-tinted rear window, rear door windows and rear side windows

Windscreen with insulating glass, heated

heated the windscreen in insulating/acoustic glass; full surface of windscreen heated without heating wires that might impair visibility, makes rapid defrosting easier and ensures that the windscreen stays mist free; heating is controlled via the deluxe automatic air conditioning. The reflective coating also reduces the build-up of heat in the interior. Without viewing window for toll collection devices

Heat-insulating glass

tinted green; windscreen and front door windows in acoustic glazing for improved external noise insulation; rear window heated, with timer

| Glazing

Insulating/acoustic glass

provides improved exterior noise insulation thanks to the 2 panes of glass bonded together by a plastic film. An additional reflective coating reduces the build-up of heat in the interior. Rear window in standard glass; windscreen with viewing window for toll collection devices

Insulating/acoustic glass and dark-tinted windows (privacy glazing)

windscreen and front door windows in insulating/acoustic glass; dark-tinted rear window, door windows and rear side windows; windscreen with viewing window for toll collection devices

Double sun visor

for driver and front passenger; simultaneous front and side protection possible; gap between visor and door pillar can be closed by means of pull-out extension

Sunblind

manually operated for the rear window and the rear door windows

| Climate control



2-zone deluxe automatic air conditioning

electronically regulates the air temperature, flow rate and distribution, separate temperature distribution for driver and front-passenger side; with ventilation via defroster vents for the windscreen and side windows; sunlight-dependent control and combined pollution, pollen and fine particulate filter; with key-coded settings; personal settings can be stored



4-zone deluxe automatic air conditioning

in addition to deluxe automatic air conditioning: air-conditioning controls in front with large TFT display and capacitive toggle switches, additional air-conditioning controls with digital display for the climate control in the rear with separately adjustable temperature and blower settings and air distribution left and right (rear functions can also be set from the front air-conditioning controls), diffuse ventilation via air nozzle strip on the front-passenger side, air nozzle strip with chrome application on the centre fin, additional air vents in the B-pillars, automatic air recirculation mode using an air quality sensor, use of residual heat, separate regulation of footwell temperature in front, individually adjustable for driver and front passenger via MMI, personal settings can be stored



Auxiliary heating/ventilation

The auxiliary heating warms up the interior and keeps the windows free of ice without starting the engine. The auxiliary ventilation system supplies fresh air and reduces the temperature of the interior. Both functions can be activated with a timer and a separate radio-operated remote control with function feedback. An intelligent control function with timer and departure time programming calculates the time- and energy-efficient heating duration. Separate radio-operated remote control with illuminated display; choice of 2 heating modes: “defrost” (defrosting mode only for the windows), “warm” (warming up mode to additionally preheat the interior)

Ioniser, front and rear*

can help to improve wellbeing and attentiveness. Ionisation reduces harmful particles and germs in the air, thus improving the air quality in the vehicle interior.

| Closing systems



Convenience key including sensor-controlled release of the luggage compartment lid

including optical distinction on the top and bottom of the key; access authorisation system: the vehicle key needs only to be carried with you; the vehicle is locked and unlocked from outside via sensors on all door handles. The luggage compartment lid can also be opened when the vehicle is locked. Upon detection of a specific foot gesture (kicking motion), a sensor in the rear bumper initiates a convenience key search in the area to the rear of the vehicle. When the key is detected, the luggage compartment lid opens. For extra comfortable loading of the luggage compartment; including stainless steel loading sill cover

Luggage compartment lid, electrically opening and closing

opens via a button on the vehicle key or in the driver door or by means of the soft-touch button in the luggage compartment lid handle recess; closes via a button on the inside of the luggage compartment lid, the button in the driver door or the optional convenience key (long press). Including power-assisted closing and programmable luggage compartment lid opening angle

Convenience key with sensor-controlled release of the luggage compartment lid including electric luggage compartment cover

features as for convenience key including sensor-controlled release of the luggage compartment lid including electrically opening and closing luggage compartment cover, can also be operated manually; including stainless steel loading sill cover

Anti-theft alarm

monitors doors, bonnet and luggage compartment lid; includes interior monitoring (can be deactivated), tow-away protection via angle of inclination sensor and signal horn independent of vehicle electrical system; with safety guarantee: prevents doors being opened from the inside as soon as the vehicle has been locked using the vehicle key

Garage door opener (HomeLink)

programmable radio-operated remote control with operating buttons integrated into the front roof module, can be used to open many garage doors and exterior gates; allows control of security and lighting systems; code identification guidance and set-up assistance through the optional MMI navigation plus. Please contact your Audi partner or visit www.eurohomelink.com for further information.

Power-assisted door closing

automatically pulls the doors into the locks when not fully closed

| Storage/transport



Trailer towing hitch including trailer assistant

The trailer assistant helps the driver guide the car/trailer combination when reversing. The driver no longer has to continuously stabilise the car/trailer combination. When activated, the system prevents a collision between the vehicle and the trailer. Car/trailer guidance via MMI rotary/push-button control; feedback in MMI display about trailer/system condition; compatible with all trailers with rigid drawbars; trailer towing hitch with electrically swivelling hitch ball; hitch ball and bar made from forged steel; operated via buttons in the luggage compartment. The integrated swivelling system socket enables continuous operation of electrical equipment in the trailer or caravan during a journey. Trailer stabilisation via the Electronic Stabilisation Control (ESC)

Storage compartments

storage compartment in the front and rear door trims, e.g. for bottles up to 1 litre, storage nets on the reverse of the front seat backrests, storage compartment in the centre console; glove compartment on the front-passenger side, lockable, large volume, illuminated, with holder for writing utensils; 2 cup holders on the centre console and one 12V socket



Rail system with load-securing kit

in the luggage compartment, with telescopic rod, attachment strap and variable lashing points for individual partitioning of the luggage compartment and for securing objects; including bag for storing small parts

Electric luggage compartment cover

electrically opening and closing luggage compartment cover; for comfortable loading of the luggage compartment; can also be operated manually; including stainless steel loading sill cover

Partition net

removable; for fastening to the bodywork or to the folded-down rear seats, useful when the rear seats are up or folded down on one side, as well as when both rear set backrests are folded down

Reversible mat

for covering the luggage compartment, can also be used with the rear seat backrest folded down; in velour on one side and rubber-coated on the other; with fold-out protective film for the loading sill and bumper

Smoker version

cigarette lighter and ashtray in the front centre console

| Instrument clusters/display instruments



Audi virtual cockpit¹

innovative, fully digital 12.3-inch instrument cluster for the flexible display of information tailored to the drivers needs such as: vehicle speed/engine speed, map representation, radio/media information etc.; the Audi virtual cockpit is operated via the multifunction steering wheel. The VIEW button on the multifunction steering wheel allows you to change between 2 differently sized representations of the round instruments. The display with small instruments allows the onboard computer and MMI contents to be shown on a large clear area of the display. The configuration of onboard computer values in the rev counter is possible. In conjunction with MMI navigation plus with MMI touch. Display of navigation map as 3D terrain model on a high-resolution 12.3-inch colour display; permanent display of navigation information near the speedometer when route guiding has been activated. The attention assist provides a warning in the Audi virtual cockpit and via acoustic signal if anything indicates that the driver is starting to become inattentive. The attention assist is active between 65 km/h and 200 km/h and can be deactivated.

Driver information system with colour display displays a host of useful information on a high-resolution 7-inch colour display in the instrument cluster. Attention assist provides a warning via acoustic signal and visual warning if the system determines that the driver's attention is lapsing. An integrated efficiency program provides fuel consumption data overviews.

| Radio/Navigation systems



MMI radio

- with high-resolution, vertically extending 7-inch centre display and separate MMI control panel, including car menu
- CD player (MP3, WMA capable), 1 SDXC card reader, AUX-IN connection, USB interface with charge function
- radio with phase diversity
- GALA (speed-sensitive volume adjustment)
- AM/FM phase diversity
- 8 passive loudspeakers at front and rear, total output 80 watts

MMI radio plus

- Bluetooth interface
- with high-resolution, vertically extending 7-inch colour display and separate MMI control panel, including car menu
- 7-inch TFT instrument cluster in colour and driver information system
- offset MMI control panel
- CD player (MP3, WMA, ACC capable), 1 SDXC card reader, AUX-IN connection
- Audi music interface (2 USB interfaces, 1 with charge and data function, 1 with charge function)
- AM/FM phase diversity
- Voice control
- GALA (speed-sensitive volume adjustment)
- Audi sound system



MMI® search

intelligent inter-device MMI search by entering free text in the navigation, phone, radio, media and vehicle menus; direct access using the joystick function of the rotary/push-button control (upwards). Results list is displayed during entry. Fast destination entry using direct search; finds results via all categories such as addresses, favourites, contacts and special destinations; fast finding of vehicle settings by means of synonym search in the vehicle menu; help function for entry with handwriting recognition; tips for touchscreen use (e.g. spaces or deletion). The entry of only a few letters of the search terms (separated by spaces) makes extremely fast destination entry possible (e.g. "Traf squa" for Trafalgar Square in London). In conjunction with MMI navigation plus with MMI touch

The model-specific standard and optional equipment can be found in the index from page 94 onwards.

¹For information on when this feature will be available, please contact your Audi partner. ²The navigation data for several countries is stored on the flash memory. For more information, please contact your Audi partner.



MMI navigation plus with MMI touch

- navigation system with high-resolution 8.3-inch colour display
- Map update²: download of current navigation data³
- 3D map representation with display of lots of sightseeing information and city models
- MMI search: free text search with intelligent destination suggestions during entry
- detailed route information: map preview, choice of alternative routes, POIs, lane recommendations, motorway exits, detailed junction maps etc.
- MMI touch: touch-sensitive control panel for fast, intuitive operation, e.g. destination entry by means of handwriting recognition as well as free movement and zooming in the map
- easy operation of the infotainment via natural language with address entered in a sentence⁴
- access to smartphone voice control
- additional display of navigation map in 7-inch driver information system or in optional fully digital 12.3-inch Audi virtual cockpit
- convenient connection of your vehicle to the internet for the use of Audi connect via an integrated data module with LTE⁵/UMTS support. SIM card reader in the surround of the MMI navigation plus with MMI touch.
- Wi-Fi hotspot for connecting mobile devices to the internet and to use the MMI connect app

- 3-month free use of Audi connect services, e.g. traffic information online, navigation with Google Earth™⁶ and Google Street View™⁶, parking information, fuel prices and more. You can receive the full use period of the services by selecting the Audi connect optional equipment or via Audi Genuine Accessories
- dynamic route guidance with TMCpro (in conjunction with Audi connect: traffic information online)
- vehicle support and speed limit display based on navigation data
- country information, e.g. on valid speed limits, motorway sticker requirement when passing the border, etc.
- myAudi special destinations: import individual point-of-interest (POI) lists to the vehicle via the myAudi portal
- MMI radio plus
- Audi sound system
- flash memory for music (10 GB)
- DVD player (MP3, WMA, AAC and MPEG-4 capable) for music CDs and video DVDs
- 2 SDXC card readers, AUX-IN connection
- Audi music interface for connecting portable media players via the USB interface (2 USB interfaces, 1 with charge and data function, 1 with charge function) or Wi-Fi
- Bluetooth interface for hands-free use and audio streaming
- display of emails and messages from mobile phone in selected languages including read-out function⁷

| Audio/Video sources



Audi tablet including Rear Seat Entertainment^{1,8}

with non-reflecting 10.1-inch touch display, HD playback with 1,920 x 1,200 pixels, memory: 32 GB, supports microSD; micro USB connection; connectivity: Bluetooth 4.0, Near Field Communication (NFC), Wi-Fi 802.11 n MIMO, Wi-Fi Direct; sound: via integrated loudspeakers, sound system of vehicle or headphones (connected via cable, Bluetooth); front camera: 2 MP resolution; operating system: Android; processor: NVIDIA Tegra 4; including preparation for Rear Seat Entertainment, can be ordered with 1 or 2 devices

The Audi tablet is removable and can therefore be used conveniently both inside and outside the vehicle.

Applications in the vehicle with MMI navigation plus with MMI touch:

- Media and radio streaming: playback on the Audi tablet can also be controlled from the front as a user aid; the desired radio station is set on the Audi tablet with excellent FM reception or optional digital radio via vehicle roof aerial; playback of MMI media from SD card, jukebox or optional DVD changer; in conjunction with TV tuner: TV playback with Audi tablet possible in rear
- Display of vehicle data

Applications in the vehicle with MMI navigation plus with MMI touch and Audi connect Wi-Fi hotspot:

- navigation function: current navigation route displayed with additional information; destinations entry on Audi tablet and transfer to the MMI navigation plus with MMI touch; highly accurate GPS data from vehicle roof aerial
- access to all apps available in Google Play⁶

Preparation for Rear Seat Entertainment¹

includes pre-installed wiring and mounts for the holders in the driver and front-passenger seat backrests. The appropriate Audi Entertainment mobile and iPad adapters are available as plug-and-play units from Audi Genuine Accessories.

DVD changer

for 6 DVDs or CDs; supports audio CDs and video DVDs; installed in shock-resistant location in luggage compartment

Digital Audio Broadcasting

In addition to the range of analogue stations, programmes from digitally broadcast radio stations⁹ can be received according to DAB standard, including DAB+ and DMB audio; display of information accompanying the programme (e.g. artist and title; depending on provision by the respective radio station) as well as additional information in the form of a slide show (e.g. cover, weather)

³The map version delivered can be updated with the first 5 updates issued at intervals of 6 months. The current navigation data can be downloaded from the myAudi platform at www.audi.com/myaudi and installed via SD card in the vehicle. In conjunction with Audi connect, the update can be carried out online in the vehicle. In addition, it is possible to have the new navigation data installed by an Audi partner at extra cost. ⁴Availability varies from country to country. ⁵Full use requires LTE card contract. For information about the availability and use of LTE support, please contact your Audi partner. ⁶Google and the Google logo are registered trademarks of Google Inc.

⁷Provided the mobile phone has the Bluetooth profile MAP (Message Access Profile). For information on compatible mobile phones, please contact your Audi partner or visit www.audi.com/bluetooth. ⁸The functions of the Audi tablet may vary from region to region. Mobile charges may be incurred. The vehicle data that can be displayed depends on the vehicle and the equipment. The navigation function requires an Audi connect Wi-Fi hotspot and internet access, in some countries exclusively follow mode with display of current vehicle position. The Google Play store requires internet access. ⁹Reception depends on local digital network availability.

| Audio/Video sources

Digital TV reception¹

reception of digitally-broadcast, uncoded television stations (in DVB-T and DVB-T2 standard with MPEG-2 or MPEG-4 video coding) as well as DVB-T audio stations; display of information accompanying the programmes such as teletext, subtitles and Electronic Programme Guide (EPG); automatic station search; external AV-IN connection via adapter cable; no picture possible when the vehicle is moving

TV reception and Digital Audio Broadcasting (DAB) contains the equipment ranges “Digital TV reception” and “Digital Audio Broadcasting”

| Sound systems



Bang&Olufsen 3D Advanced Sound System

fascinating sound reproduction via 23 loudspeakers including 3D Sound loudspeaker, centre speaker and subwoofer, each with its own amplifier and exclusive aluminium loudspeaker covers; centre speaker and 2 automatically extending acoustic lenses on the instrument panel for superb true-to-detail sound performance from every seat. The 23-channel amplifier with integrated high-efficiency ICE Power amplifiers has a total output of 1,920 watts. Dynamic driving noise compensation and speed-sensitive volume adjustment; spatial sound reproduction with the new sound feature 3D Sound for the front seats. This sound is created by means of additional loudspeakers in the A-pillar, the midrange speakers and the Fraunhofer technology Symphoria. The 3D sound can be created with all sources, creating a uniquely authentic stereo and 3D surround experience in the vehicle. Symphoria adds to the dimensions which are indispensable for natural sound: width, depth and height. This creates a previously unknown feeling of space in the car. At the same time, the physical limits of the passenger cell also seem to disintegrate: the vehicle interior sounds larger, allowing music to unfold in its purest form.

Bose 3D Sound System

impressive sound reproduction with 19 loudspeakers including 3D Sound loudspeaker, centre speaker and subwoofer, 15-channel amplifier with a total output of 558 watts; spatial sound reproduction with the new sound feature 3D Sound for the front seats. This is created by means of additional loudspeakers in the A-pillar, the midrange speakers and Bose Advanced Staging Technology. The 3D sound can be created with all sources. This creates a uniquely authentic 3D surround experience in the vehicle, giving the impression of sitting in the first row of a concert hall. Lighting in the loudspeaker covers

The 3D Sound concept:

First a semantic analysis process is applied to separate the individual sound components within the audio signal into direct sound, early reflections and reverberation. Then the algorithm from the Fraunhofer technology Symphoria intelligently distributes the separated audio objects in the vehicle without adding artificially generated components to the music signal. This results in high-quality 3D surround sound.

Audi sound system

impressive sound thanks to 6-channel amplifier with a total output of 180 watts and 10 loudspeakers including centre speaker and subwoofer

| Phone

Bluetooth interface

allows hands-free calls to be made in the vehicle using the microphone and, depending on the mobile phone compatibility, Bluetooth audio streaming.

Bluetooth-capable mobile phones can be connected to the vehicle via the interface. Part of Radio plus and MMI navigation plus with MMI touch

Audi phone box³

allows phone calls with improved reception quality by placing mobile phone into the compartment in the front centre console; can be charged via USB connection and wireless charging (Qi standard)⁴; hands-free facility and voice control (phone); low SAR radiation in the interior of the vehicle thanks to connection to vehicle aerial; operated via radio/navigation systems or the multifunction leather steering wheel. In conjunction with Audi connect, Audi phone box includes a car phone function via SIM card slot or rSAP profiles.

| mySmartphone



Audi smartphone interface⁴

The Audi smartphone interface connects your smartphone to your Audi. It transfers your smartphone contents to the MMI display directly and seamlessly via USB. Navigation, telephony, music and selected third-party apps can be conveniently controlled using the MMI controller and by voice control.⁵



Access to smartphone voice control

MMI navigation plus (incl. voice control system), Bluetooth interface and multifunction steering wheel allow the use of the voice control of the mobile phone (e.g. Siri from Apple iPhone) connected via Bluetooth. The smartphone voice control is activated by pressing and holding the key for the voice control system on the multifunction steering wheel; uses the vehicle's microphone and loudspeaker for optimal voice recognition and sound whilst driving

| Audi connect

convenient connection of your vehicle to the internet for the use of Audi connect via an integrated data module with LTE⁶/UMTS support. Audi connect with LTE⁶ data module for a more stable, up to 10 times faster data connection and better coverage in rural areas. The MMI navigation plus with MMI touch card reader for the SIM card is located in the glove compartment.

Includes support by Audi connect services from the categories: myRoute, myNetwork, myInfo, myRoadmusic

Legal notice about "Audi connect"

Use of the services supported by Audi connect is possible only with the optional MMI navigation plus equipment and with Audi connect. You also require a SIM card with data option and with LTE option to use LTE. In conjunction with the optional equipment Audi phone box, a SIM card with phone and data option or a Bluetooth-capable smartphone with remote SIM Access Profile (rSAP)³ is required for the use of the integrated car phone function. The services are available only in conjunction with an existing or separate mobile phone contract and only within the range of the respective mobile phone network. Additional costs may be incurred when receiving data packets from the internet, depending on the terms of your mobile phone contract, particularly when used abroad. Because of the high data volumes involved, a data flat rate is strongly recommended.

The availability of the services supported by Audi connect varies from country to country. The Audi connect services are provided for at least 1 year from vehicle delivery. Following a period of 24 months, Audi connect services are extended once free of charge for 12 months. If you do not wish the service to be extended free of charge, please write to:

AUDI AG
Kundenbetreuung Deutschland
D-85045 Ingolstadt
E-mail: kundenbetreuung@audi.de
Tel.: 0800-2834 7378423

The services city events, train information, flight information and possible further services are available to customers for 12 months. Ask your Audi partner about a subsequent extension of the Audi connect services.

Audi connect allows access to Facebook, Google and Twitter services. Permanent availability cannot be guaranteed, Facebook, Google and Twitter are responsible for this.

Please visit www.audi.com/connect or contact your Audi partner for more detailed information about Audi connect; contact your mobile services provider for information about contract conditions.

¹Please note: TV reception depends on digital network availability; no picture possible when the vehicle is moving. Contents and scope of the additional information depend on provision by the respective TV station. The playback of encrypted programs (e.g. pay TV) is not possible. ²Reception depends on local digital network availability. ³For information on compatible mobile phones, please contact your Audi partner or visit www.audi.com/bluetooth.

⁴For information on when this feature will be available and in which countries, please contact your Audi partner. ⁵For information about the compatibility of your smartphone, please contact your mobile phone manufacturer.

⁶Full use requires LTE card contract. For information about the availability and use of LTE support, please contact your Audi partner.

| myAudi



Your personal control centre

provides you with password-protected access to www.audi.com/myaudi where, following one-off registration, you are able to put together the services supported by Audi connect that you require, and manage and configure them from the comfort of your own home. You can also use many of these services via the Audi MMI connect app on your smartphone (Android 4.0 and higher or iOS 6 and higher) while you're on the road.

| Audi MMI® connect app

The Audi MMI connect app available for some smartphones supports the following connect services amongst other things:

- online media streaming with AUPEO!, Napster and Audi music stream
- Point-of-interest search
- destination entry via myAudi or Google Maps
- traffic information online
- Travel

In addition, the Audi MMI connect app is also required to run the optional services of the myCarManager category.

| myRoute



Navigation with Google Earth™² and Google Street View™²

makes orientation easier by means of high-resolution aerial and satellite images. A realistic image of the destination even before commencing driving: drivers can “virtually” drive through streets and view them from every point of view with Google Street View™²



Point-of-interest (POI) search with voice control

Access to the entire breadth of the extensive internet database means that networked navigation allows searches for special destinations by entering free text and supplies appropriate informations such as photos, opening hours and visitor reviews.



Travel

Information about travel destinations (e.g. restaurants, museums, points of interest), intelligent search and a variety of filter options. With the MMI connect app, you can conveniently select travel destinations, create favourites and import them to the navigation system in the vehicle as destinations.



Travel information

Travel information about the current vicinity, the travel destination or any selected destination – a search engine gives you professionally prepared sightseeing information, and you can directly import the destinations to the navigation system.



Destination entry via myAudi or Google Maps™²

If you want, you can plan your navigation destinations conveniently from your PC or smartphone. myAudi and Google Maps³ and the Audi MMI connect app allow individual navigation destinations to be sent to the vehicle. When you start your journey, these can easily be loaded as your destination.



Traffic information online

Traffic information is displayed in colour in the navigation map and considered in the dynamic route guidance. The continuous data update quickly gives you information about the development and resolution of traffic jams. Thanks to the superb coverage of the road network, e.g. including country roads and in cities.



Parking information

Help with looking for car parks and multi-storeys. Plus – where available – information on prices and currently vacant spaces



myAudi – special destinations⁴

the navigation system as a personal road atlas: import individual point-of-interest (POI) lists to the vehicle via the myAudi portal



Map update online⁴

allows the map data to be updated directly in the vehicle via an existing LTE connection. The update can be made with the first 5 updates issued at intervals of 6 months. Alternatively, the download can also be launched via the myAudi platform at www.audi.com/myAudi and installed via SD card in the vehicle. Or the new navigation data can be installed by an Audi partner at extra cost.

| myNetwork



Wi-Fi hotspot

wirelessly connects your mobile devices to the internet



Access to Facebook

integrates your personal network into the cockpit. With text-to-speech and other convenient text functions



Messages

sent to your Audi MMI; enjoy the convenience of having text messages (SMS) read out to you and writing them using the dictation function



Email^{4,5}

can be transmitted via Bluetooth to the Audi MMI and conveniently read out



Access to Twitter

integrates the Twitter message service into the cockpit; with text-to-speech and other convenient text functions

| myInfo



News online (individual)

text and images about current world events, with text-to-speech function, can be configured individually via news sources (RSS feeds)



Fuel prices

the cheapest petrol stations at your destination or in the vicinity, sorted by prices and distance



Weather

Weather forecasts and severe weather warnings are presented with descriptive charts and weather maps, allowing the weather for the next 2 days to be forecast by the hour or displayed on the rain radar. The weather information, such as severe weather warnings and weather in the vicinity, can also be integrated into the navigation map.



Country information⁴

displays the legal regulations for a specific country, such as whether it is compulsory to carry a high-visibility vest or purchase a motorway sticker as well as maximum speeds, when the vehicle crosses a border.

¹ Depending on country-specific availability. You will generally require a media streaming service account to use this service which can lead to additional costs. ² Google and the Google logo are registered trademarks of Google Inc.

³ Destination entry via Google Maps requires a Google account. ⁴ The service is part of MMI navigation plus with MMI touch. ⁵ For information on compatible mobile phones, please contact your Audi partner or visit www.audi.com/bluetooth.

| myRoadmusic



Online media streaming with AUPEO!®, Napster and Audi music stream¹

the customised music station and the right song always at your fingertips regardless of where you are, at home or on holiday: simply connect your own smartphone with MMI® Navigation plus with MMI touch via Wi-Fi and access personal radio services (AUPEO!®), global radio stations (Audi music stream) and music streaming services (Napster) or select the music stored on the smartphone

| Audi connect emergency call & service

contains the services of the categories myCarManager and myService

Legal notice about “Audi connect emergency call & service”

The services are provided via a SIM card installed in the vehicle. The costs for calls and data connections are included in the price for the services. Audi connect services are available only within the range of the selected mobile phone network operated by Audi’s chosen mobile phone provider. The Audi connect services emergency call, online roadside assistance and Audi service request are available for 10 years after vehicle delivery in the following countries: Belgium, Germany, Finland, France, Italy, Liechtenstein, Luxembourg, Monaco, the Netherlands, Norway, Austria, Portugal, Russia, Sweden, Switzerland, Spain and the UK. Ask your Audi partner about when the services will become available in additional European countries and about the availability of the special equipment.

General legal notice about the equipment Audi connect emergency call & service and Audi connect

Disruption to the services may occur due to force majeure and official orders as well as technical and other measures carried out on the systems of AUDI AG, suppliers or network operators to ensure their proper function (e.g. maintenance, repair, system-related software updates, extensions). AUDI AG will make every reasonable effort to eliminate such disruption immediately or to work towards a resolution.

| myService



Emergency call²

automatically triggers an emergency call in the event of an accident; for fast, targeted assistance: transmission of relevant data such as the accident location and severity to the Audi emergency call centre; manual emergency call, e.g. in order to request help for other road users



Online roadside assistance²

easy activation of the online roadside assistance by means of the service call button in the roof module; fast assistance by transmitting vehicle data



Audi service request²

after registration and activation via myAudi, Audi service request notifies the Audi service partner selected by you when servicing is due. You are contacted in advance by the service partner.

| myCarManager³

Security & convenience²

Audi connect security & convenience services can be used to conveniently control and operate numerous vehicle functions from your smartphone via the MMI connect app. Audi connect security & convenience includes the following services:



Vehicle status report²

smartphone retrieval of km status, lock status of doors/windows, tank fill level



Remote Lock&Unlock²

allows the vehicle to be locked and unlocked using your smartphone



Car Finder²

displays the last parking position in a map



Remote auxiliary heating²

allows the auxiliary heating to be started conveniently via a smartphone app (only in conjunction with the optional auxiliary heating equipment)

| Assistance systems



Night vision assistant⁴

assists the driver when driving at night by displaying a thermal image of the surroundings. People and larger wild animals detected are marked yellow on the colour display of the driver information system. If they move or if the system determines from their position that there is a potential risk, the marking changes to red, a warning triangle appears and a warning tone is emitted.

In conjunction with 1 of the following lighting systems, a marked person is also illuminated with 3 successive brief flashes of the headlights (marking light):

- Xenon plus in combination with high-beam assist
- LED headlights including high-beam assist
- Audi Matrix LED headlights

Additional display of warnings in the optional head-up display; actuation using the button next to the light switch

Hold assist⁴

stops the vehicle over an indefinite period of time in the uphill or downhill gradients usual in traffic. The system is activated by push-button and allows the driver to drive away smoothly.



Head-up display

Information relevant to the driver from assistance systems, navigation instructions and warnings is projected as required onto the windscreen in the driver's direct field of vision. The height-adjustable head-up display provides a multicoloured view with good contrast within the driver's field of vision.

Cruise control⁴

at speeds from about 30 to 250 km/h and above, the system keeps the set speed constant, provided that engine power and engine braking effect permit it; operated via separate steering column stalk, set speed displayed in driver information system. The LIM button can be used to switch between the cruise control and the programmable speed limiter. In speed limiter mode, driving proceeds with the accelerator as normal, but the driving speed is limited to the set speed. This speed limit can be temporarily deactivated/overridden by kickdown. The speed limit is operated and adjusted using the same functions as the cruise control and the adaptive cruise control. The programmable speed limiter can be adjusted between 30 and 250 km/h in single and 10 km/h steps.

| Assistance systems – City

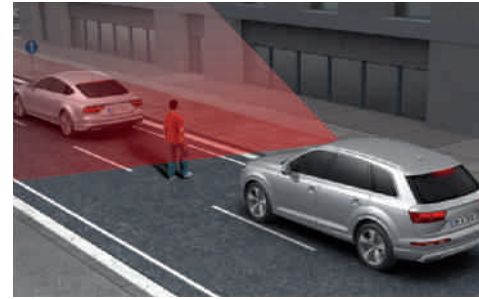

Audi pre sense city⁴

can detect vehicles and pedestrians in a speed range of up to approx. 85 km/h. If an imminent collision is detected, the system warns the driver and, if necessary, can initiate a maximum deceleration action to reduce the speed or, if possible, prevent the collision.

Assistance systems – City^{4,5}

- parking system plus
- reversing camera
- Audi side assist
- Audi pre sense rear
- exit warning
- intersection assistant

Includes a selection of assistance systems specially designed for city traffic. The intersection assistant at the rear assists the driver when reversing out of perpendicular parking spaces. The system notifies the driver about detected approaching vehicles in the MMI display and, in situations recognised as especially critical, can additionally warn the driver with a warning tone and, if necessary, by briefly jerking the brakes.



Audi side assist^{4,5}

warns by means of an LED display on the relevant exterior mirror of any situations deemed critical for lane-changing. 2 radar sensors detect vehicles approaching from behind at the side and measure the distance and the difference in speed. The lane change assistant provides assistance between speeds of around 10 and 250 km/h. When the vehicle is stationary, the exit warning can detect vehicles and bicycles approaching from the rear and, if necessary, warn the passengers before opening the door. The passengers are warned by brightly flashing warning LEDs in the doors. Includes Audi pre sense basic and Audi pre sense rear: working within system limits, the system uses additionally installed radar sensors to detect possible rear-end collisions. The front seat belts are preventively tensioned electronically and the seat pneumatic system is pumped up in customised contour seats. In addition, the windows and, if available, sliding roof begin to close. The hazard warning lights are activated to flash at high frequency to warn the surrounding traffic. One-off activation via MMI car menu

Audi pre sense basic⁴

automatically initiates any required preventive measures for your protection and that of other passengers; these include: tensioning of the front seat belts to minimise occupants shifting forward or to the side, activation of the hazard warning lights and the closing operation for the panoramic glass sunroof (if ordered) and windows; categorises driving situations by linking different vehicle systems

¹ Depending on country-specific availability. You will generally require a media streaming service account to use this service which can lead to additional costs.

² For information on when this feature will be available, please contact your Audi partner. ³ These functions are only available in a limited number of applications depending on the charge state of the vehicle battery. ⁴ Please note: The systems work only within system limits and can support the driver. However, the driver remains responsible for driving the vehicle and is required to be attentive at all times.

⁵ Depending on country-specific availability.

| Assistance systems – Tour



Camera-based recognition of traffic signs¹

camera-based recognition and display of overtaking bans, speed limits, including temporary speed limit displays (e.g. above motorways). Working within system limits, the system also detects the beginnings and ends of motorways, express motorways, towns and traffic-calmed areas, displaying the appropriate speed limits. In addition, a situation-dependent evaluation is made when using a trailer (with a factory-fitted trailer towing hitch), and when encountering wet conditions, fog, or speed limits that vary depending on the time of day. If a traffic sign is located outside of the visual range of the camera, the information is called up from data stored as part of MMI Navigation plus with MMI touch. The traffic sign recognition automatically appears in the instrument cluster display or Audi virtual cockpit and can be configured with the multifunction steering wheel. You can view up to 3 traffic signs by themselves or have the current speed limit displayed as part of another system (e.g. digital speed display). The system has a purely informative function. The MMI also offers the option of selecting a traffic-sign-based warning when the detected speed limit is exceeded.

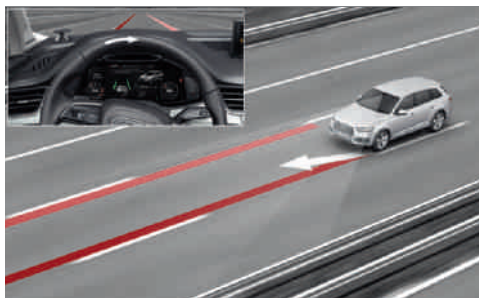

Audi active lane assist¹

helps the driver comfortably keep in lane (operating range from approx. 60 to 250 km/h maximum). If the system is activated and ready and the driver has not activated an indicator, Audi active lane assist will help to guide the vehicle within recognised lane boundary lines by means of gentle, corrective steering intervention. The driver can choose whether assistance be given continuously or just shortly before crossing the road marking (choice of earlier or later steering time). Additional steering wheel vibration can be set if the driver wishes; including high-beam assist. In conjunction with MMI navigation plus with MMI touch, the system includes the camera-based recognition of traffic signs.



Assistance package – Tour^{1, 2}

- adaptive cruise control
- congestion assistant³
- Audi active lane assist
- traffic sign recognition
- high-beam assist
- predictive efficiency assistant,^{3, 4}

adaptive cruise control (ACC) offers automatic distance control in a control range of approx. 0 to 250 km/h. The system automatically brakes and accelerates the vehicle to keep the preset distance virtually constant. Choice of 5 distance levels. In addition, the acceleration and control behaviour can be configured via Audi drive select. The Stop&Go function allows independent braking to a stop and automated restart at the driver's request.

The congestion assistant assists the driver with steering at speeds from 0 to 60 km/h: working within system limits, the system detects lane markings, roadside structures, vehicles on adjacent lanes and multiple vehicles ahead. From this information, the system derives a virtual driving path within which it then guides the vehicle. Since it takes into account so many parameters, the congestion assistant makes it as easy and natural as possible to drive in congested traffic situations. Upwards of approx. 60 km/h, Audi active lane assist assists the driver to stay in lane.

In conjunction with MMI navigation plus with MMI touch and head-up display, adaptive cruise control also uses the data from the predictive efficiency assistant for a predictive and adaptive speed control even when there are no vehicles ahead. To do this, the system uses the information about curve radii (curve assistant), town entrances and speed limits (speed limit assistant) stored in the navigation data. The system is supported by information from the camera-based recognition of traffic signs, which is also included. Moreover, the predictive efficiency assistant provides targeted control of coasting and freewheeling phases, thereby promoting fuel-saving driving even when adaptive cruise control is active.

Audi pre sense front supplements Audi pre sense city with a collision warning as well as partial and, if necessary, full braking action over the entire speed range up to approx. 250 km/h. The avoidance assistant gives additional assistance to the driver during a critical avoidance manoeuvre by providing supportive steering torque. In addition, an avoidance path is determined on the basis of the distance to the vehicle in front, its width and transverse offset. The avoidance assistant is activated as soon as the system detects an imminent collision and the driver initiates the avoidance manoeuvre. Working within system limits, the turning assistant detects oncoming vehicles on the opposing lane when turning left. If the system detects a critical situation during the turning process, an automatic braking operation is triggered. The system is active as soon as the driver activates the indicator and the vehicle is travelling within a speed range of approx. 2 to 10 km/h.

Operation of adaptive cruise control via separate steering column stalk. Audi pre sense front can be deactivated via the MMI car menu.

| Parking systems



Park assist¹

searches for suitable parking space along the road by means of ultrasonic sensors and provides support when parking and leaving by means of independent steering action. Calculates the right parking path for perpendicular parking spaces and the right parking and exiting paths for parallel parking spaces. The driver has to accelerate, apply the brakes and monitor the parking process. The display of the surroundings warns the driver of any obstacles at the side of the vehicle in accordance with the steering angle. Parking in several moves is supported. Optionally available in addition with reversing camera or 360 degree cameras; activated via a button on the centre console

Parking system, rear¹

makes reverse parking easier by indicating acoustically how far away the vehicle is from an object detected behind the vehicle; measurement is by ultrasonic sensors integrated discreetly in the bumper; active when reverse gear is selected

Parking system plus¹

Acoustic and visual front and rear parking system assists with parking and manoeuvring. Shown in the MMI display; measurement by ultrasonic sensors concealed in the bumpers; optionally available with additional reversing camera or 360 degree cameras. Activated by selecting reverse gear, via a button in the centre console and automatically as soon as the distance to a recognised object is less than approx. 90 cm.

Reversing camera¹

Image of area behind the vehicle shown on the MMI display, with dynamic display modes showing the path calculated based on steering angle; auxiliary lines and guidelines as well as indication of the point at which to apply opposite lock when parallel parking; reversing camera integrated discreetly in the handle strip of the luggage compartment lid; activated by selecting reverse gear or via a button on the centre console. Choice of 2 modes (perpendicular parking mode and, with factory-fitted trailer towing hitch, trailer mode).

Assistance package Parking¹

- 360 degree cameras
- Park assist

The 4 wide-angle 360 degree cameras cover the entire area directly around the vehicle, allowing a number of different views to make manoeuvring even easier:

- reversing camera view: with aids for perpendicular parking and attaching trailers (with factory-fitted trailer towing hitch)
- panorama view, front and rear: the nearly 180 view makes it easier to pull out of narrow parking spaces, courtyard entrances or blind intersections
- virtual overhead view: the images from the 4 cameras are combined to form a virtual overhead view (bird's-eye view). Allows more precise manoeuvring and positioning of the vehicle

Activated by selecting reverse gear (360 degree cameras) or via a button in the centre console (park assist)

| Driving dynamics/brakes



adaptive air suspension

automatically regulates the vehicle height and damping by means of the electronically controlled air suspension with infinitely variable adaptive damping system on all 4 wheels; including level control and rear lowering to facilitate loading; 5 different modes (auto, comfort, dynamic, allroad, lift/offroad) set via the MMI system; in conjunction with MMI navigation plus with MMI touch including tilt angle display

adaptive air suspension – sport

electronically controlled air suspension with infinitely variable adaptive damping system on all 4 wheels, automatically controls vehicle level and damping; 5 modes (auto, comfort, dynamic, allroad, lift/offroad) set via the MMI system; including level control and rear lowering to facilitate loading; in conjunction with MMI navigation plus with MMI touch including tilt angle display



Audi drive select

allows vehicle characteristics to be set in the available modes auto, comfort, dynamic, efficiency, allroad, offroad or lift/offroad and also custom-set by adjusting the power steering assistance, engine characteristics, gear changing characteristics, adaptive air suspension (optional), with additional optional equipment that can also be adjusted. The efficiency mode shifts the engine, transmission, climate control and optional adaptive cruise control or cruise control to a more fuel-efficient basic setting.

Dynamic suspension

5-link front axle with steering mechanism at the front and independent wheel suspension; aluminium transverse link, suspension subframe and stabiliser; 5-link rear axle with steering link at the back, suspension subframe and stabiliser

¹Please note: The systems work only within system limits and can support the driver. However, the driver remains responsible for driving the vehicle and is required to be attentive at all times.

²Depending on country-specific availability. ³For information on when this feature will be available, please contact your Audi partner. ⁴Only available in conjunction with head-up display.

| Driving dynamics/brakes



quattro®

quattro permanent all-wheel drive with asymmetric/dynamic torque distribution through a self-locking centre differential and wheel-selective torque control. The system integrated in the Electronic Stabilisation Control (ESC) distributes the drive torque to all wheels depending on the driving situation by means of targeted braking actions. It actively countersteers in bends. The result is improved traction and dynamic performance when cornering and more precise and neutral handling (less understeer). Agility during steering is also improved.

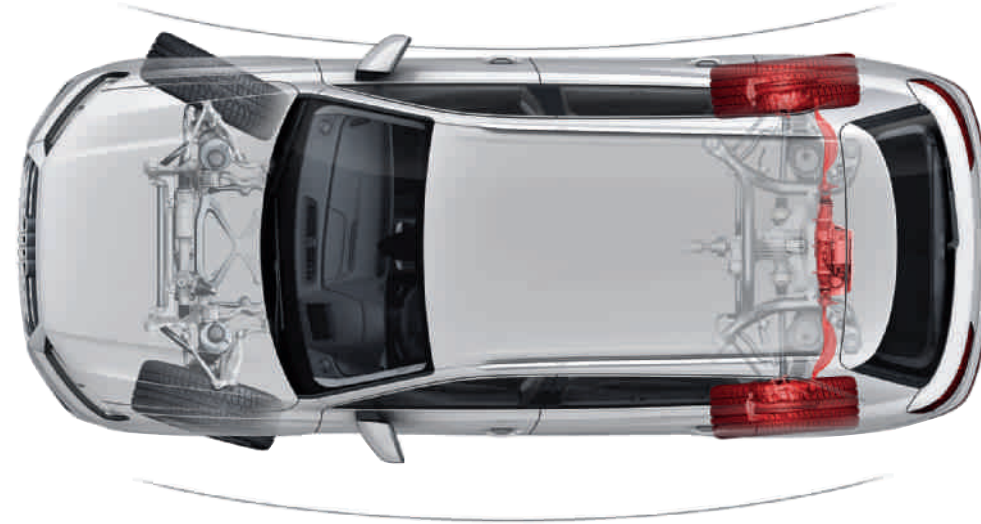

All-wheel steering

enhances handling and driving comfort with additional rear axle steerability. In a low speed range, this gives the vehicle high agility and manoeuvrability. The steering angle of the rear axle is in opposition to that of the front axle, which reduces the turning circle and the driving path width. In the upper speed range, steering in the same direction improves responsiveness while increasing the driving dynamics and vehicle stability. The all-wheel steering supports the parking and manoeuvring operations carried out by the park assist and the trailer assistant. Overall, the all-wheel steering allows easy manoeuvring, sporty driving behaviour and superb, comfortable steering behaviour.

Electronic Stabilisation Control (ESC)

The brake control system's basic functions ABS, EBV, ESC, ASR and EDS provide high stability and increased traction by means of situation-dependent intervention in the engine management system and the vehicle braking system. The adaptive ABS uses offroad detection to optimise the braking performance depending on the driving surface. ESC offroad mode provides for increased traction and optimised stabilisation. The HDC supports the driver during critical downhill drives. The system automatically detects mounted roof racks and adjusts the ESC functions accordingly. All delay, stop and parking commands of the assistance systems are centrally coordinated and executed in the brake control system.

tiptronic

8-speed automatic transmission with Dynamic Shift Program (DSP) and sport program; option of manual control via shift paddles on the multifunction leather steering wheel or by nudging the selector lever

| Technology/safety

Recuperation

economises on fuel through brake energy recovery; kinetic energy is converted into usable electrical energy by increasing the generator voltage when the vehicle is coasting or braking and relieving the generator during subsequent acceleration

Start-stop system

helps to reduce fuel consumption and CO₂ emissions by automatically switching off the engine when the vehicle is stationary, e.g. at traffic lights. The start process is initiated as soon as the foot brake is released. Can be deactivated at any time via a button

Audi TDI clean diesel

In addition to the standard equipment with catalytic converter and diesel particulate filter, the models with TDI clean diesel have an exhaust aftertreatment system which results in low exhaust emissions. This technology significantly reduces nitrogen oxides by injecting small amounts of the biodegradable additive AdBlue* into the exhaust flow. The nitrogen oxides are then split into nitrogen and water in the nitrogen oxide catalytic converter (DeNOx catalytic converter). Refill the separate AdBlue tank as indicated by the information in the display of the instrument cluster. We recommend having the AdBlue tank refilled at your Audi partner.

ISOFIX child seat mounting and Top Tether

Standard bracket for the safe and practical fastening of ISOFIX child seats; includes additional attachment points on all rear seats and electric child-proof lock on the rear doors.

You can obtain the recommended child seats from your Audi partner.

ISOFIX child seat mounting for the front-passenger seat

with front-passenger airbag deactivation switch, includes separate electric child-proof lock for the rear doors

| Audi Extended Warranty

Audi Extended Warranty

The Audi Extended Warranty provides extended risk cover and cost control beyond the first 2 years of the manufacturer's warranty for a variety of claims. It can be ordered directly and only on purchase of a new car. Choice of 9 combinations of service life and mileage. For more information, please contact your Audi partner.



Further information can be obtained from the Audi Q7 accessories catalogue, at www.audi.com, and from your Audi partner.

Cast aluminium wheels in 10-arm Talea design, matt black

A wheel with an unusual design. In size 9.5 J x 21 for 285/40 R 21 tyres.

Audi Genuine Accessories. As individual as the life you lead.

Dynamic movement from A to B. And then, inspired, just keep driving. This is par for the course with your Audi Q7. Not least because it is prepared for a multitude of individual requirements from A to Z. Thanks to Audi Genuine Accessories. Products that will inspire you to new destinations again and again. And keep all our quality promises day in, day out. Benefit from customised solutions with convincing design and functionality. Because creativity in development and high production standards alongside numerous testing procedures are just as decisive for Audi Genuine Accessories as for the Audi vehicles themselves. Discover which tailor-made ideas Audi Genuine Accessories have ready for your lifestyle. A few highlights are illustrated here, but please contact your Audi partner for more information on the complete range.

¹ For information on when this feature will be available, please contact your Audi partner. ² Available for retrofitting from Audi Genuine Accessories.





Audi Entertainment mobile¹

With its 10-inch touch screen, the third generation Audi Entertainment mobile promises maximum entertainment in excellent image quality while honouring progressive Audi design. It is an excellent platform for videos, photos, games and music. Intuitive software, numerous connection options (SD, USB 2.0, HDMI-IN, etc.) and high functionality included. Internet access is possible by connecting to a Wi-Fi hotspot (e.g. via Audi wireless internet access). The device can be fitted in the vehicle on the backrests of the front seats or used outside the vehicle. Requirement: preparation for Rear Seat Entertainment.

Roof box bags (not illustrated)

Sturdy yet flexible. And including a waterproof base with a waterproof edge 5 cm in height. The individual bags can be combined in different ways to make optimum use of the Audi roof boxes. Available in 3 sizes: S (43 l), M (76 l) and L (82 l).

Carrier unit

for various roof rack modules such as cycle rack, kayak rack or ski and luggage box. The profile section is made from anodised aluminium tube. The carrier unit is easy to install and lockable. Maximum permissible total weight of carrier, modules and load 100 kg.



Ski and luggage boxes

New Audi design with improved aerodynamics thanks to a flat, sporty look. Platinum grey roof box with brilliant black side blade and chrome-plated Audi rings; top-quality, rivet-free look. Can be locked and opened on both sides for convenient loading and unloading. With inner handle for pulling the box closed. Simple quick-attachment system including torque restriction. Position moved forward for better access to the luggage compartment. Available in 3 sizes: 300 l, 360 l (illustrated above) and 405 l.

Premium textile floor mats and rubber floor mats

Tailor-made for the floor dimensions of the Audi Q7. The floor mats are always fixed at the front using the points provided on the floor area of the vehicle. With Q7 logo.



Luggage compartment tray

High-cut plastic insert, with a sturdy design and is easy to clean. Ideally suited for all pieces of luggage that often leave marks during transport. Wide grooves prevent the load slipping.

**Partition grille**

With the practical partition grilles (lengthways and sideways), the luggage compartment can be separated from the remaining interior and can also be divided lengthways. The partition grille is easy and convenient to attach without any drilling.



Rear seat box

Sturdy stowage box for various small utensils. The high-quality rear seat box with a volume of approx. 12 l makes travelling even more convenient. In a few easy steps, it can be attached to the rear seat bench with a standard 3-point belt. Includes a net bag and pull straps in the interior to fix contents.

Backrest cover (not illustrated)

Practical protection against soiling the backrest of your car seat. Easy to wash. Also serves as protection against treads from child passengers and offers additional luggage space thanks to 4 small pockets. Matches the design of child seats, child seat pad and the entire interior. Not for integrated head restraints.

Child seat pad (not illustrated)

Matches the design of the child seats and the vehicle interior. Protects the vehicle seats from soiling and any pressure marks caused by the child seats. With 2 practical storage bags. Can be installed with all Audi child seats, including with ISOFIX connection.

ISOFIX base (not illustrated)

For a better support of the Audi baby seat and the Audi child seat. Enables quick mounting and removal. The adjustable support foot provides additional stability. Optimises the level of protection for the child. Note: The ISOFIX base is optional for the baby seat, but is essential for the child seat.



Audi child seat

Can be used facing forwards or backwards. With adjustable seat, integrated safety harness and adjustable head restraint. Cloth cover can be removed and washed, is breathable and gentle on the skin, certified in accordance with Oeko-Tex® standard 100. Can only be used in conjunction with the ISOFIX base. Suitable for children from 9 to 18 kg (approximately 12 months to 4 years). Also available: Audi child seat youngster plus for children from 15 to 36 kg (approximately 4 to 12 years) and Audi baby seat for infants up to 13 kg (approximately 12 months). All child seats are available in the colours Misano red/black and titanium grey/black.



Model	Audi Q7 3.0 TFSI (245 kW)				Audi Q7 3.0 TDI (200 kW)⁹			
Engine type	V6 petrol engine with direct fuel injection and mechanical supercharger				V6 diesel engine with common rail injection system and turbocharging			
Displacement in cc (valves per cylinder)	2,995 (4)				2,967 (4)			
Max. output ¹ in kW at rpm	245/5,500-6,500				200/3,250-4,250			
Max. torque in Nm at rpm	440/2,900-5,300				600/1,500-3,000			
Power transmission								
Drive type	quattro [®] permanent all-wheel drive				quattro [®] permanent all-wheel drive			
Transmission type	8-speed tiptronic				8-speed tiptronic			
Weights/capacities								
	5-seater		7-seater		5-seater		7-seater	
Unladen weight ² in kg	2,045		2,105		2,070		2,135	
Gross vehicle weight in kg	2,740		2,910		2,765		2,940	
Permissible roof load limit/ nose weight in kg	100/115 (100/140 ⁴)		100/115 (100/140 ⁴)		100/115 (100/140 ⁴)		100/115 (100/140 ⁴)	
Trailer load limit ³ in kg								
unbraked	750		750		750		750	
12 % gradient	2,700 (3,500 ⁴)		2,800 (3,500 ⁴)		2,700 (3,500 ⁴)		2,800 (3,500 ⁴)	
8 % gradient	2,700 (3,500 ⁴)		2,800 (3,500 ⁴)		2,700 (3,500 ⁴)		2,800 (3,500 ⁴)	
Fuel tank capacity, approx. in l	85		85		75		75	
Performance/consumption⁵								
Top speed in km/h	250		250		234		234	
Acceleration 0-100 km/h in s	6.1		6.3		6.3		6.5	
Fuel grade	Sulphur-free super RON 95 ⁶				Sulphur-free diesel ⁷			
Fuel consumption ⁸ in l/100 km								
urban	9.7-9.4		10.0-9.6		6.5-6.2		6.7-6.4	
extra-urban	7.2-6.8		7.3-6.9		5.8-5.4		6.0-5.6	
combined	8.1-7.7		8.3-7.9		6.1-5.7		6.2-5.9	
CO ₂ emission ⁸ in g/km								
urban	226-218		231-222		170-161		174-167	
extra-urban	167-157		170-160		153-142		157-147	
combined	189-179		193-183		159-149		163-153	
Emission standard	EU6		EU6		EU6		EU6	

Explanatory notes









- ¹ The figure given was calculated using the specified measuring procedure (current version of UN-R 85).
- ² Unladen vehicle weight includes driver (75 kg) and fuel tank 90 % full, calculated in accordance with the current version of Reg. (EU) 1230/2012. Optional equipment may increase the car's unladen weight and drag coefficient, whereupon the possible payload limit and the top speed will be reduced accordingly.
- ³ The engine's power output always decreases with increasing altitude. At 1,000 m above sea level, and for every additional 1,000 m, deduct 10 % from the weight of the outfit (trailer load limit + gross weight of the towing vehicle). Figure for trailer load limit applies to factory-fitted trailer towing hitch. If using the vehicle with a trailer towing hitch for commercial purposes, a digital tachograph may be required under certain conditions.
- ⁴ Figures refer to vehicles with the optionally available adaptive air suspension/adaptive air suspension – sport.
- ⁵ Fuel consumption and CO₂ emission figures given in ranges depend on the tyre/wheel sets used.
- ⁶ We recommend using sulphur-free super unleaded RON 95 fuel complying with DIN EN 228. If this is not available, use sulphur-free regular unleaded RON 91 fuel complying with DIN EN 228; power output will be slightly reduced. Unleaded RON 95 fuel with a maximum ethanol content of 10 % (E10) can generally be used. Fuel consumption details refer to operation with RON 95 fuel in accordance with 692/2008/EC.
- ⁷ We recommend using sulphur-free diesel complying with DIN EN 590. If this is not available, use diesel complying with DIN EN 590.
- ⁸ The figures given were calculated using the specified measuring procedures. The figures do not refer to one individual vehicle and do not form part of any offer, but rather should be used purely for purposes of comparison between the different vehicle models.
- ⁹ Refill the separate AdBlue® tank as indicated by the information in the display of the instrument cluster. We recommend having the AdBlue tank refilled by your Audi partner.

Important note

Special information about the wheels: Wheels with gloss turned finish as well as polished or partly polished aluminium wheels must not be used in wintry road conditions. For manufacturing reasons, the rim surface does not have sufficient corrosion protection for such use and can be damaged permanently by road salt or similar.

Classifications of tyre parameters

The table shows the range of fuel efficiency, wet grip and exterior noise emission classes for the different tyre sizes of the Audi Q7.

	Tyre size	Fuel efficiency class	Wet grip class	Exterior noise emission class
Summer tyres	235/65 R 18	C	A	71 
	255/60 R 18	E	A	72 
	255/55 R 19	E-C	B	71 
	285/45 R 20	C	B	71 
	285/40 R 21	C	B	71 
Winter tyres	255/60 R 18	C	C	72 
	255/55 R 19	C	C	72 
	285/45 R 20	E	C	70 
	255/50 R 20	E	C	73 

It is not possible to order a specific tyre. Ask your Audi partner about the range of tyres available in your country.

Offroad properties

Climbing ability as %

Ground clearance in mm

Overhang angle in ° front
rear

Ramp angle in °

Fording depth in mm

6-cylinder models

60

210/245*

23.1/25.4*
14.4/22.1*

13.1/20.9*

500/535*

* Figures refer to vehicles with the optionally available adaptive air suspension/adaptive air suspension – sport.

Audi Q7 5-seater

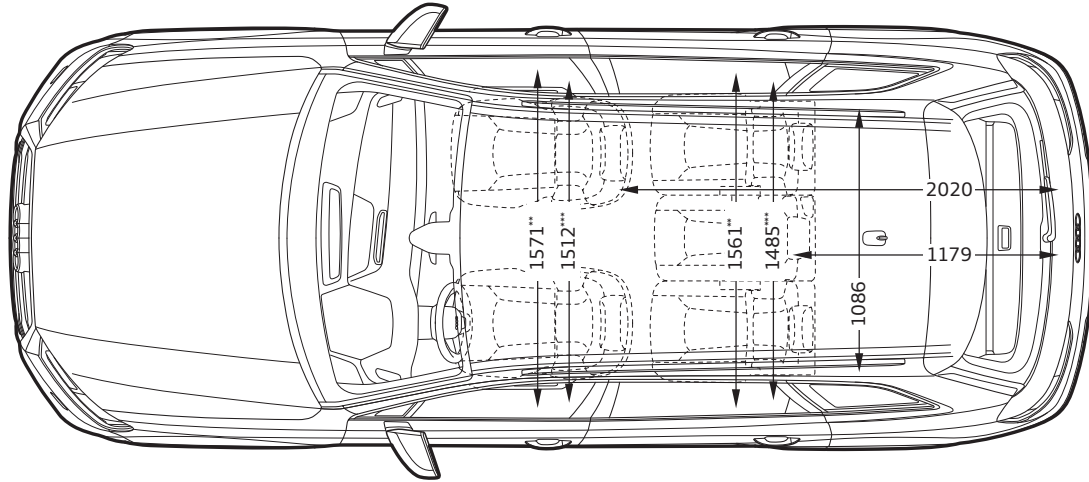
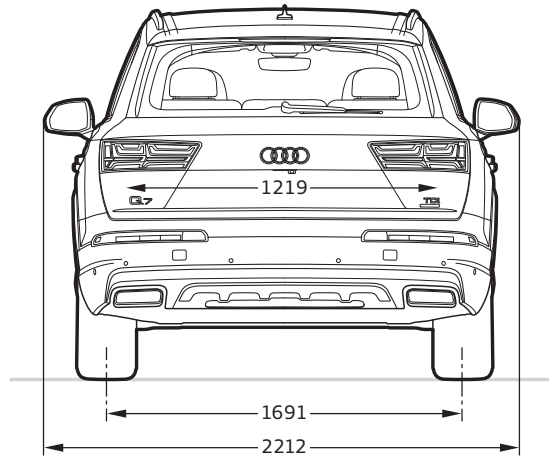
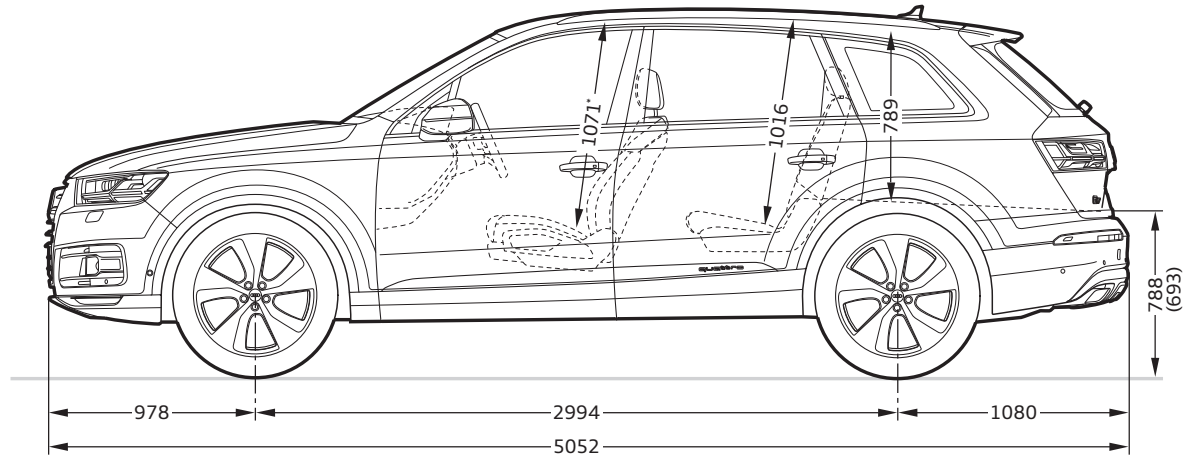
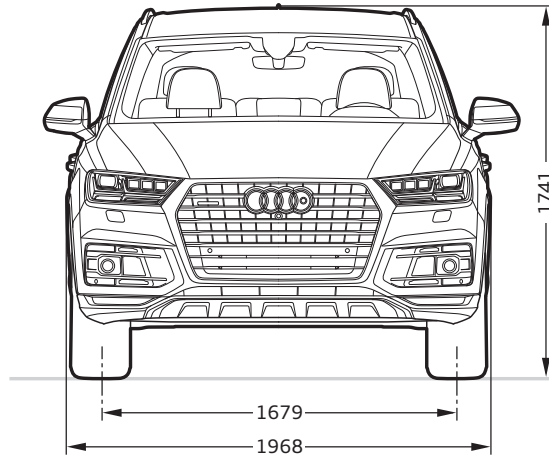
**Dimensions in millimetres.**

Dimensions were measured with vehicle at unladen weight.

Luggage capacity in l: 890/2,075 (second value with the rear seat backrest folded down and vehicle loaded up to roof height).

Turning circle approx. 12.4 m.

*Maximum headroom. **Elbow room width. ***Shoulder room width.

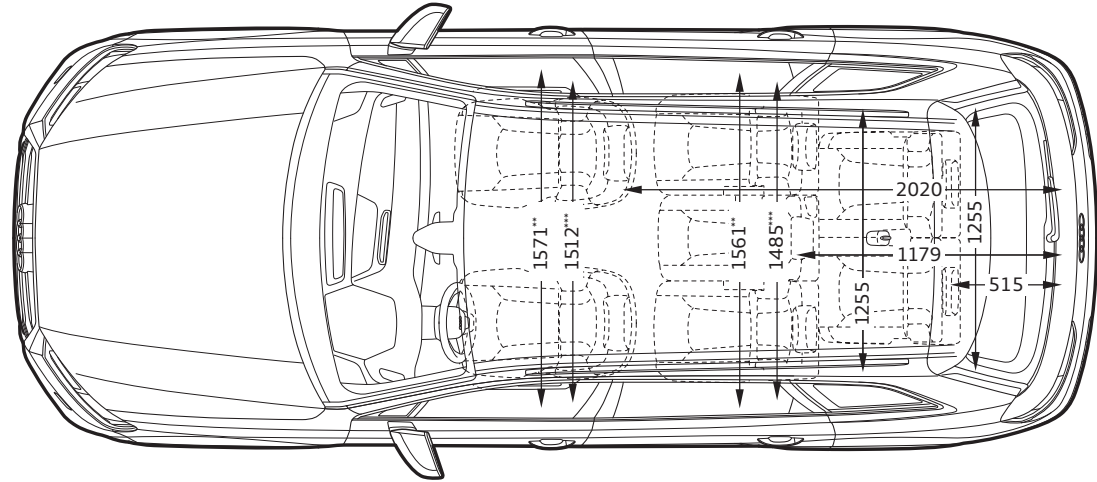
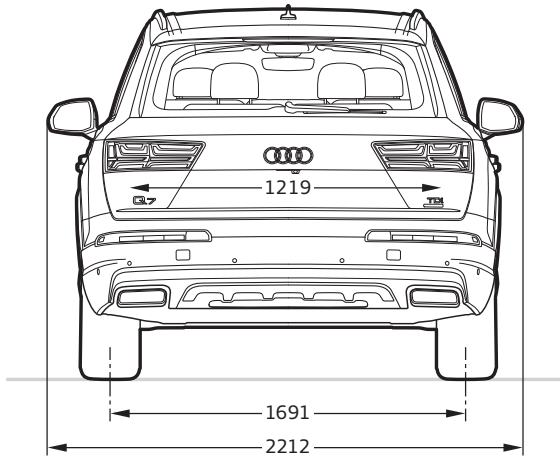
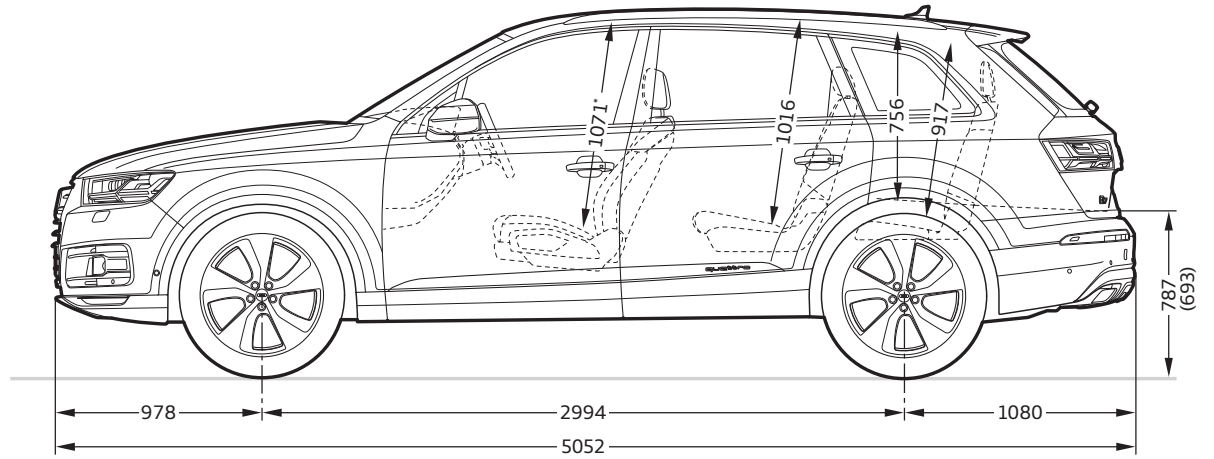
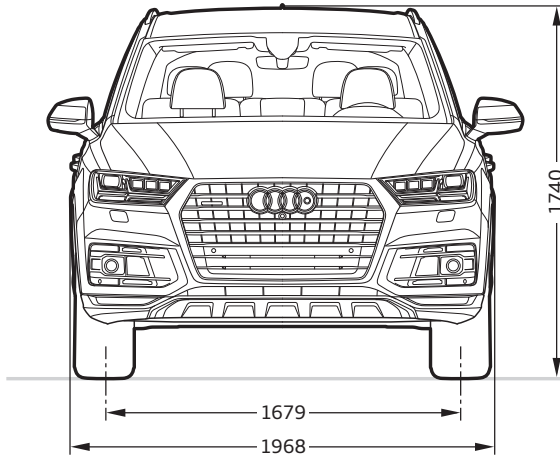











Dimensions in millimetres.







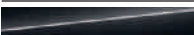

Dimensions were measured with vehicle at unladen weight.

Luggage capacity in l: 295/770/1,955 (second value: with 3rd row of seats folded down; third value: with the rear seat backrest folded down and vehicle loaded up to roof height).

Turning circle approx. 12.4 m.

*Maximum headroom.** Elbow room width.***Shoulder room width.









	Page	Q7
Lines and packages	52	
S line exterior package		■
S line sport package		■
Audi design selection Murillo brown		■
Solid paint finishes	58	
 Carrara white		□
 Night black		□
Metallic paint finishes	58	
 Glacier white, metallic		■
 Floret silver, metallic		■
 Diamond beige, metallic		■
 Argus brown, metallic		■
 Ink blue, metallic		■
 Graphite grey, metallic		■
 Orca black, metallic		■
Pearl effect paint finish	59	
 Daytona grey, pearl effect ¹		■
Customised paint finishes	59	
 Audi exclusive customised paint finishes		■









	Page	Q7
Wheels/tyres	60	
 18" cast aluminium wheels in 10-spoke design ³		□
 18" forged aluminium wheels in 5-arm design ⁴		□
 19" cast aluminium wheels in 5-V-spoke design		■
 19" cast aluminium wheels in 5-spoke star design		■
 19" Audi Sport cast aluminium wheels in 7-twin-spoke design with RS logo ²		■
 20" cast aluminium wheels in 10-spoke star design, contrasting grey, partly polished ⁵		■
 20" cast aluminium wheels in 5-parallel-spoke design, (S design) ¹		■
 20" Audi Sport cast aluminium wheels in 10-Y-spoke design ²		■

□ Standard equipment ■ Optional equipment □ ■ Standard/optional equipment varies by model

Country-specific variations possible. Please find out from your local Audi partner which equipment is standard and what optional equipment is available in your country.











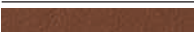
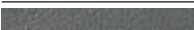

More detailed descriptions of a selection of items from the equipment range can be found from page 46 onwards.

	Page	Q7
		■
Audi Sport 20" cast aluminium wheels in 5-arm offroad design in titanium look, gloss turned finish ^{2,5}		
		■
21" forged aluminium wheels in 5-arm turbine design, contrasting grey, partly polished ⁵		
		■
21" Audi Sport cast aluminium wheels in 5-twin-spoke design with RS logo		
		■
21" Audi Sport cast aluminium wheels in 5-twin-spoke design, matt titanium look, gloss turned finish with RS logo ^{2,5}		
		■
18" forged aluminium winter wheels in 5-arm design		
		■
19" cast aluminium winter wheels in 5-spoke star design		
		■
20" cast aluminium winter wheels in 10-spoke star design		
		■
20" cast aluminium winter wheels in 5-parallel-spoke design (S design) ¹		

	Page	Q7
Anti-theft wheel bolts		■
Tyre repair kit		□
Spare wheel, space-saving		■
Tyre pressure loss indicator		□
Tyre pressure monitoring system		■
Vehicle tool kit		□
Vehicle jack		■
Seats	62	
Standard seats, front		□
Sport seats, front		■
Customised contour seats		■
Seat upholstery for standard seats, front	64	
 Initial cloth, black		□
 Leather/artificial leather, black ⁶		■
 Leather/artificial leather, nougat brown ⁶		■
 Leather/artificial leather, rock grey ⁶		■
 Leather/artificial leather, pistachio beige ⁶		■
 Cricket leather, black ⁶		■
 Cricket leather, rock grey ⁶		■
 Cricket leather, pistachio beige ⁶		■

¹ Only available in conjunction with S line sport package. ² For information on when this feature will be available, please contact your Audi partner. ³ Standard for Q7 3.0 TDI (200 kW). ⁴ Standard for Q7 3.0 TFSI (245 kW).

⁵ Please note the special information relating to wheels on page 91. ⁶ In conjunction with front seat ventilation, the leather on the front and outer rear seats is perforated.





	Page	Q7
Seat upholstery for sport seats, front	65	
 Alcantara/leather, black		■
 Alcantara/leather, rock grey		■
 Perforated Alcantara/leather, black with contrasting stitching¹		■
 Valcona leather, black		■
 Valcona leather, black with contrasting stitching¹		■
 Valcona leather, cedar brown		■
 Valcona leather, rock grey		■
 Valcona leather, rotor grey with contrasting stitching¹		■
 Audi exclusive leather upholstery and trim		■
Seat upholstery for individually contoured seats	65	
 Perforated Valcona leather, black		■
 Perforated Valcona leather, cedar brown		■
 Perforated Valcona leather, rock grey		■
 Perforated Valcona leather, pistachio beige		■
 Perforated Valcona leather, Murillo brown with contrasting stitching in granite grey²		■
 Audi exclusive leather upholstery and trim		■
Cloth and leather upholstery and trim	64	
Initial cloth upholstery and trim		<input type="checkbox"/>
Cricket leather upholstery and trim		■
Alcantara/leather combination		■
Valcona leather upholstery and trim		■
Leather/artificial leather combination		■









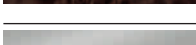
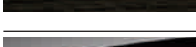
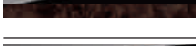
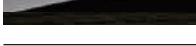

	Page	Q7
Leather packages	64	
Leather package		■
Extended leather package		■
Full-leather package		■
Audi exclusive leather upholstery and trim (package 1) in Valcona leather		■
Audi exclusive leather upholstery and trim (package 2) in Valcona leather		■
Audi exclusive leather upholstery and trim (package 2) in Alcantara/Valcona leather		■
Audi exclusive leather upholstery and trim (package 3) in Valcona leather		■
Audi exclusive leather upholstery and trim (package 4) in Valcona leather		■
Audi exclusive leather upholstery and trim (package 4) in Alcantara/Valcona leather		■
Seat comfort	64	
Front seats, electrically adjustable, including memory function for the driver seat		■
Front seats, electrically adjustable, including memory function for both front seats		■
Memory function		■
Seat heating, front		■
Seat heating, front and rear		■
Seat ventilation, front		■
Massage function, front		■
Centre armrest, front		<input type="checkbox"/>
Comfort centre armrest, front		■
Head restraints, front		<input type="checkbox"/>
X-head restraints, front with fore/aft adjustment		■

Standard equipment Optional equipment

Country-specific variations possible. Please find out from your local Audi partner which equipment is standard and what optional equipment is available in your country.

More detailed descriptions of a selection of items from the equipment range can be found from page 46 onwards.

	Page	Q7
Seats in the rear	64	
Rear seat backrest, split-folding		<input type="checkbox"/>
Rear seat bench plus		<input checked="" type="checkbox"/>
3rd row of seats		<input checked="" type="checkbox"/>
Centre armrest, rear		<input checked="" type="checkbox"/>
Headlinings	64	
Headlining in cloth		<input type="checkbox"/>
Headlining in cloth, black		<input checked="" type="checkbox"/>
Headlining in Alcantara		<input checked="" type="checkbox"/>
Headlining in Alcantara, black		<input checked="" type="checkbox"/>
Upper/lower inlays	66	
 Diamond paint finish, silver grey/anodysed paint finish, anthracite		<input type="checkbox"/>
 Brushed aluminium, Sono/anodysed paint finish, anthracite		<input checked="" type="checkbox"/>
 Brushed aluminium, Sono/chrome paint finish, slate grey¹		<input checked="" type="checkbox"/>
 Diamond paint finish, silver grey/walnut, terra brown		<input checked="" type="checkbox"/>
 Diamond paint finish, silver grey/oak, grey		<input checked="" type="checkbox"/>
 High gloss black/walnut, terra brown		<input checked="" type="checkbox"/>
 High gloss black/oak, grey		<input checked="" type="checkbox"/>
 High gloss black/Beaufort walnut		<input checked="" type="checkbox"/>

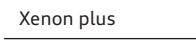
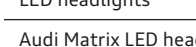
	Page	Q7
 Brushed aluminium, Sono/walnut, terra brown		<input checked="" type="checkbox"/>
 Brushed aluminium, Sono/oak, grey		<input checked="" type="checkbox"/>
 Brushed aluminium, Sono/Beaufort walnut		<input checked="" type="checkbox"/>
 Brushed aluminium, Sono/sycamore, natural dark brown²		<input checked="" type="checkbox"/>
Audi exclusive lower inlays	67	
 Audi exclusive modrone, gold³		<input checked="" type="checkbox"/>
 Audi exclusive tamo ash, natural dark brown³		<input checked="" type="checkbox"/>
 Audi exclusive vavona, bronze³		<input checked="" type="checkbox"/>
 Audi exclusive fine grain ash, nougat³		<input checked="" type="checkbox"/>
 Audi exclusive oak sepia³		<input checked="" type="checkbox"/>
 Audi exclusive fine grain myrtle, nutmeg brown³		<input checked="" type="checkbox"/>
 Audi exclusive aluminium/Beaufort wood, black⁴		<input checked="" type="checkbox"/>
 Audi exclusive piano finish, black³		<input checked="" type="checkbox"/>
Headlights	68	
Xenon plus		<input type="checkbox"/>
LED headlights		<input checked="" type="checkbox"/>
Audi Matrix LED headlights		<input checked="" type="checkbox"/>
Headlight cleaning system⁵		<input checked="" type="checkbox"/>
High-beam assist		<input checked="" type="checkbox"/>
Light/rain sensor		<input type="checkbox"/>
LED rear lights		<input type="checkbox"/>
LED rear lights with dynamic indicator		<input checked="" type="checkbox"/>

¹ Only available in conjunction with S line sport package. ² Can only be ordered in conjunction with Audi design selection. ³ Available in conjunction with upper inlays in high gloss black, diamond paint finish, silver grey or brushed aluminium, Sono. ⁴ Available in conjunction with upper inlays in high gloss black or brushed aluminium, Sono. ⁵ Part of xenon plus or LED headlights.

	Page	Q7
Interior lighting	69	
Interior lighting in LED technology		<input type="checkbox"/>
Lighting package		<input checked="" type="checkbox"/>
Ambient lighting		<input checked="" type="checkbox"/>
Exterior design	69	
Model name/logo		<input type="checkbox"/>
Audi Singleframe		<input type="checkbox"/>
Lightweight body, in multi-material design		<input type="checkbox"/>
Full paint finish		<input checked="" type="checkbox"/>
Bottom bumper, non-painted/attachments in plastic, grained in anthracite		<input type="checkbox"/>
Roof rails		<input type="checkbox"/>
Roof rails, black		<input checked="" type="checkbox"/>
Roof edge spoiler		<input type="checkbox"/>
Exhaust tailpipes		<input type="checkbox"/>
Gloss package		<input type="checkbox"/>
Audi exclusive black gloss package ³		<input checked="" type="checkbox"/>
Interior design	70	
Loading sill protector in plastic		<input type="checkbox"/>
Loading sill protector in stainless steel		<input checked="" type="checkbox"/>
Door sill trims with aluminium inlays		<input type="checkbox"/>
Door sill trims with S line logo ¹		<input checked="" type="checkbox"/>
Audi exclusive floor mats		<input checked="" type="checkbox"/>
Audi exclusive carpet and floor mats		<input checked="" type="checkbox"/>

	Page	Q7
Steering wheels/controls	70	
Leather steering wheel in 4-spoke design with multifunction plus and shift paddles		<input type="checkbox"/>
Leather steering wheel in 4-spoke design with multifunction plus and shift paddles including steering wheel heating		<input checked="" type="checkbox"/>
Sport leather steering wheel in 3-spoke design with multifunction plus and shift paddles		<input checked="" type="checkbox"/>
Sport leather steering wheel in 3-spoke design with multifunction plus and shift paddles including steering wheel heating		<input checked="" type="checkbox"/>
Sport contour leather steering wheel in 3-spoke design, flattened at the bottom, with multifunction plus and shift paddles ²		<input checked="" type="checkbox"/>
Electric steering wheel adjustment		<input checked="" type="checkbox"/>
Audi exclusive leather controls		<input checked="" type="checkbox"/>
Mirrors	71	
Exterior mirrors with integrated LED indicator		<input type="checkbox"/>
Exterior mirrors, additionally with memory function		<input checked="" type="checkbox"/>
Exterior mirrors, additionally automatically dimming on both sides		<input checked="" type="checkbox"/>
Exterior mirrors, additionally automatically dimming on both sides, with memory function		<input checked="" type="checkbox"/>
Interior mirror, manually dimming		<input type="checkbox"/>
Interior mirror, automatically dimming		<input checked="" type="checkbox"/>
Roof system	71	
Panoramic glass sunroof		<input checked="" type="checkbox"/>
Glazing	71	
Heat-insulating glass, tinted green: windscreen and front door windows in acoustic glazing		<input type="checkbox"/>
Windscreen with insulating glass, heated		<input checked="" type="checkbox"/>
Insulating/acoustic glazing		<input checked="" type="checkbox"/>

Standard equipment Optional equipment

Country-specific variations possible. Please find out from your local Audi partner which equipment is standard and what optional equipment is available in your country.

More detailed descriptions of a selection of items from the equipment range can be found from page 46 onwards.

	Page	Q7
Dark-tinted windows (privacy glazing)		■
Double sun visor		■
Sunblind		■
Sun visors		□
Climate control	72	
2-zone deluxe automatic air conditioning		□
4-zone deluxe automatic air conditioning		■
Auxiliary heating/ventilation		■
Ioniser, front and rear ³		■
Closing systems	73	
Remote control key		□
Luggage compartment lid, electrically opening and closing		□
Engine start-stop button		□
Convenience key including sensor-controlled release of the luggage compartment lid		■
Convenience key with sensor-controlled release of the luggage compartment lid including electric luggage compartment cover		■
Anti-theft alarm		■
Garage door opener (HomeLink)		■
Power-assisted door closing		■
Storage/transport	73	
Storage compartments including nets on the rear seat backrest of the front seats		□
Cup holders		□
Partition net		■
Electric luggage compartment cover		■
Luggage compartment cover, extendable		□

	Page	Q7
Reversible mat		■
Lashing points		□
Rail system with load-securing kit		■
Non-smoker version		□
Smoker design		■
Trailer towing hitch including trailer assistant		■
Instrument clusters/display instruments	74	
Instrument cluster		□
Driver information system with colour display		□
Audi virtual cockpit		■
Radio/Navigation systems	74	
MMI® radio		□
MMI® radio plus		■
MMI® navigation plus with MMI touch		■
Audio/Video sources	75	
1 Audi tablet		■
2 Audi tablets		■
Audi tablet including Rear Seat Entertainment ³		■
Preparation for Rear Seat Entertainment ³		■
DVD changer		■
Digital Audio Broadcasting		■
Digital TV reception		■
TV reception and Digital Audio Broadcasting (DAB)		■

¹ Only available in conjunction with S line exterior package or S line sport package. ² Only available in conjunction with S line sport package. ³ For information on when this feature will be available, please contact your Audi partner.

	Page	Q7
Sound systems	76	
Bang&Olufsen 3D Advanced Sound System		■
Bose 3D Sound System		■
Audi sound system		■
Phone	77	
Bluetooth interface		■
Audi phone box		■
mySmartphone	77	
Audi smartphone interface		■
Access to smartphone voice control		■
Audi connect	77	
Audi connect		■
Audi connect emergency call & service		■
Assistance systems	81	
Hold assist		□
Cruise control		□
Programmable speed limiter		□
Night vision assistant		■
Parking system, rear		□
Parking system plus		■
Park assist		■
Reversing camera		■
Assistance package Parking		■
Audi pre sense basic		■
Audi pre sense city		■
Audi side assist with exit warning and Audi pre sense rear		■

	Page	Q7
Assistance systems – City		■
Camera-based recognition of traffic signs		■
Audi active lane assist		■
Assistance package Tour		■
Head-up display		■
Driving dynamics/brakes	83	
Audi drive select		□
Dynamic suspension		□
adaptive air suspension		■
adaptive air suspension – sport		■
quattro®		□
tiptronic		□
Electromechanical power steering		□
All-wheel steering		■
Brake system		□
Electromechanical parking brake		□
Technology/safety	85	
Antilock Brake System (ABS)		□
Anti-Slip Regulation (ASR)		□
Electronic Differential Lock (EDL)		□
Electronic Stabilisation Control (ESC)		□
Fuel tank (75 l) with additional 12 l AdBlue tank ¹		□
Fuel tank (85 l) with additional 24 l AdBlue tank ²		■
Fuel tank (85 l) ³		□
Recuperation		□
Start-stop system		□

□ Standard equipment ■ Optional equipment

Country-specific variations possible. Please find out from your local Audi partner which equipment is standard and what optional equipment is available in your country.

More detailed descriptions of a selection of items from the equipment range can be found from page 46 onwards.

	Page	Q7
Audi TDI clean diesel		<input type="checkbox"/>
Airbags		<input type="checkbox"/>
Side airbags, front, and head airbag system		<input type="checkbox"/>
Side airbags, rear		<input checked="" type="checkbox"/>
Integrated head restraint system		<input type="checkbox"/>
Safety steering column		<input type="checkbox"/>
Seat belt reminder		<input type="checkbox"/>
ISOFIX child seat mounting and Top Tether		<input type="checkbox"/>
ISOFIX child seat mounting for the front-passenger seat		<input checked="" type="checkbox"/>
Deactivation switch for the front-passenger airbag		<input type="checkbox"/>
First-aid kit		<input checked="" type="checkbox"/>
Warning triangle		<input checked="" type="checkbox"/>
Audi Extended Warranty	85	
Audi Extended Warranty		<input checked="" type="checkbox"/>

Equipment for the Audi Q7 illustrated (p. 429):

Paint finish: Sepang blue, pearl effect (available as Audi customised paint finish)

Wheels: forged aluminium wheels in 5-arm turbine design, contrasting grey, partly polished⁴

Seat upholstery: Valcona leather, cedar brown

Upper inlay: brushed aluminium, Sono

Lower inlay: oak, grey

¹Standard for Q7 3.0 TDI (200 kW). ²Only available for Q7 3.0 TDI (200 kW). ³Standard for Q7 3.0 TFSI (245 kW). ⁴Please note the special information relating to wheels on page 91.

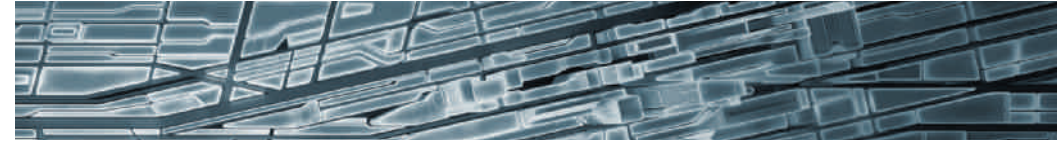

Discover



The Audi experience

The fascination of Audi can be experienced in many different ways. Audi City in Berlin, Audi City in London and Audi City in Beijing, for example, give you digital access to all models at their actual size and in real time. And of course it is always worth visiting one of the major motor shows. This is where Audi always presents its new models and invites you to take a look at how the future is being shaped with "Vorsprung durch Technik". Anyone interested in seeing how Audi is already putting this into practice will find fascinating insight in the "Vorsprung durch Technik" online special at www.audi.com. But a look back can also be rewarding: at the Audi museum mobile in Ingolstadt, history and high-tech go hand in hand. A total of 130 historic exhibits and state-of-the-art

forms of presentation make for a thrilling symbiosis. Plus, Audi driving experience allows you to live the excitement and countless possibilities of current Audi models. Here, pure driving enjoyment is combined with valuable learning effects. This is ensured by a team of specially trained and highly qualified instructors who provide practical tips to help you optimise your driving skills. All this can now also be enjoyed at the recently opened Audi driving experience center in Neuburg, near Ingolstadt. Facilities here include a circuit of up to 3.4 kilometres that features challenging combinations of bends, a 30,000 m² dynamic driving area and an offroad section where Q models can be put through their paces.





Responsibility

Living up to our responsibilities is a principle that is firmly anchored in Audi strategy. Alongside commercial success and international competitiveness, our responsibility toward company employees and society as a whole is a key consideration, as is protecting the environment and conserving resources. And what is true in the details – our catalogues are printed on FSC-certified paper – also holds in general: Audi develops cars that are not only sporty and emotive but also ever more efficient. In the long run, Audi wants its products to allow CO₂-

neutral mobility. Seeing to it that production in Audi plants gradually becomes CO₂-neutral is another aspect of our comprehensive approach. Audi is also committed to society – particularly in the fields of education, technology and social projects. At Audi, sustainability is closely linked with how we see the future: the Audi Urban Future Initiative sees Audi working with international experts to get to the root of future urban challenges and trends in mobility.

the world of Audi.



Choosing an Audi means choosing a brand that offers more. More individuality. More exclusivity. More fascination.

Team spirit

Motorsport is a driving force behind the brand. For years Audi has been among the champions in various racing series, for instance the 24 Hours of Le Mans or the DTM German Touring Car Masters. The values that are crucial in many different areas of sport are also central ones for Audi: precision, passion and technology. No coincidence then that Audi has been sponsoring sporting events for

many years. In the world of winter sports, for example, Audi has been the main sponsor of the German Ski Association (DSV) for almost three decades and has also partnered 16 other national alpine teams. In football, we support national and international teams. And Audi is also a partner for the German Olympic Sports Confederation.

www.audi.com

Information on all the topics mentioned above can be found on our website: www.audi.com.



www.audi.com



www.audi.com/driving



configurator.audi.com



www.audi.com/cr



www.audi.com/vorsprung-durch-technik



AUDI AG
85045 Ingolstadt
www.audi.com
Valid from March 2015

Printed in Germany
533/1133.29.24

The models and equipment versions illustrated and described in this brochure and some of the services listed are not available in all countries. Some of the cars illustrated are equipped with optional features for which an extra charge is made. Details concerning the delivery specifications, appearance, performance, dimensions and weights, fuel consumption and running costs of the vehicles were correct to the best of our knowledge at the time of going to press. Deviations from the colours and shapes shown in the illustrations may occur. No liability is accepted for errors and printing errors. The right to introduce modifications is reserved. Not to be reproduced, including in part, without the written approval of AUDI AG.

This brochure is printed on paper made from pulp bleached without the use of chlorine.

