

C-Class Coupé



Mercedes-Benz





First impressions

On the outside, it's a dynamic coupé whose looks never fail to cause a stir. Inside, however, it's an oasis of calm, a place to relax and enjoy every bend and straight in total comfort. It's the C-Class Coupé, a winning combination of luxury, personality and driving pleasure.

With efficiently powerful engines, ECO start/stop, Agility Control suspension and standard-setting safety technology.

[Overview](#) | [from page 4](#) [Insights](#) | [from page 14](#)

Featured models:

C 350 BlueEFFICIENCY AMG Sport | Palladium Silver metallic | front page and page 2

AMG alloy wheels in 7-spoke design, Flamenco Red leather, dark brushed aluminium trim

C 250 CDI BlueEFFICIENCY AMG Sport | Diamond White metallic | page 9

AMG alloy wheels in 7-spoke design, Black cloth/Artico artificial leather

Specifications shown may include optional equipment and accessories

See Mercedes-Benz in a new light. With a wide selection of new finance and upgrade offers available across our model range, now is a great time to get yourself behind the wheel of a Mercedes-Benz. For further information contact your local Mercedes-Benz Retailer or visit www.mercedes-benz.co.uk/offers



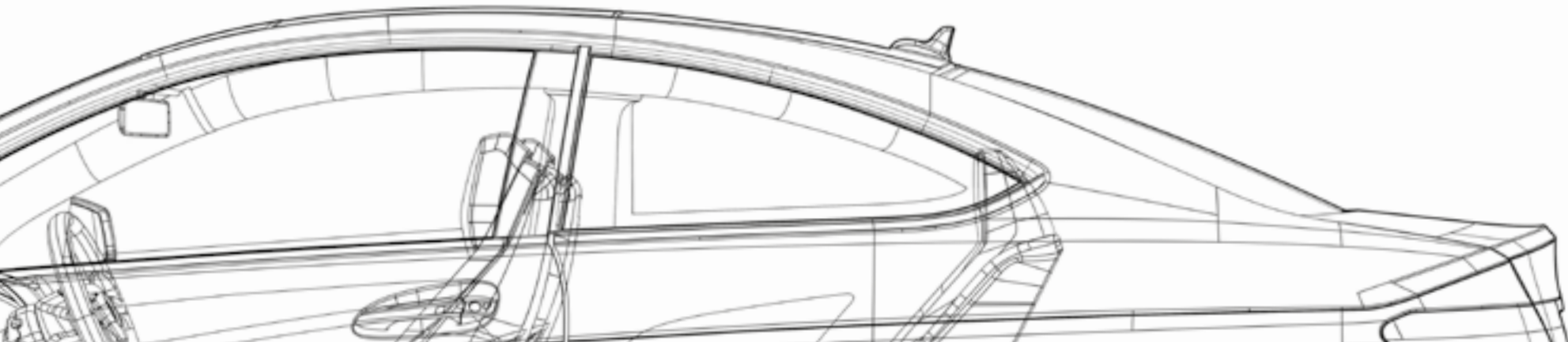

Facts

Agile style: BlueEFFICIENCY, diesel and petrol engines, transmissions, suspension and Dynamic Handling Package.

Engines and suspension | from page 17

Protective instincts: innovative technologies that enhance occupant protection and help to avoid accidents.

Safety | from page 25

Relaxing enjoyment: multimedia systems, electronic assistants, automatic climate control and coupé-specific seats.

Comfort and convenience | from page 29

Adrenalin machine: the C 63 AMG Coupé plus AMG Performance Studio options.

AMG | from page 35

Your personal coupé: standard equipment and optional extras, C-Class Coupé AMG Sport, alloy wheels and Retailer-fit accessories.

Equipment | from page 43

More Mercedes-Benz: test drive, Mercedes-Benz Finance and Insurance, Factory Collection, Interactive Owner's Manual, Roadside Assistance and Mercedes-Benz World.

Services | from page 57

The C-Class Coupé in figures: dimensions, paint finishes and technical data.

Facts and finishes | from page 59



When it comes to gear shifts, we like to keep things short

The drive may be unforgettable, but with 7G-Tronic Plus the shifts are barely perceptible. Fitted as standard on the C 250 BlueEFFICIENCY and C 350 BlueEFFICIENCY, and optional on all other 4-cylinder models, this 7-speed automatic transmission delivers fast and effortless gear changes without you even lifting a finger. In fact, if it wasn't for the rapid flicking of the rev counter, you might not even notice them at all. → page 23





Two doors, no compromises: concentrated coupé flair

The stance is low-slung; the face unmistakable, a large three-pointed star dominating its two-bar grille. The rear? Compact, muscular and broad-shouldered. It's a coupé for those who don't stand still.



Care instructions:
apply regularly to tarmac







And now for some cuts everyone will welcome

The C-Class Coupé comes with new-generation engines that achieve significant reductions in fuel consumption. What's more, its ECO start/stop function and on-demand ancillaries help to improve efficiency even further. Good for your conscience – and for your wallet. → pages 18–21



Welcome to the coupé lounge



A sixth sense also comes as standard

The C-Class Coupé always seems to know what's just ahead. Its safety systems are constantly evaluating the current situation and anticipating the next, helping you to stay out of danger whenever possible.

The Adaptive Brake System, for instance, can prime the brakes even before you press the pedal, ensuring they react faster – and bring the car to a standstill more quickly.



Your first Mercedes?
We promise it won't be your last





The styling alone deserves
a standing ovation





Even the most striking of looks can be made more so, as the AMG Sport model proves. Its exterior wears AMG bodystyling and alloy wheels; its cabin boasts unique coupé seats and a 3-spoke sports steering wheel. And if that doesn't get the adrenalin flowing, the noticeably sportier drive surely will. → page 45



Thankfully, cloud nine can also be reached on the ground

For the briefest of moments, the stunt plane seems to hang in mid-air. Onlookers catch their breath, no one utters a sound. Suddenly, it begins to plummet, seemingly in freefall. The pilot, however, remains totally calm. He waits and waits then, gripping the control column, pulls the aircraft around and sends it spiralling upwards again. It's a manoeuvre that requires the highest levels of confidence and skill – one which inspires not just aviation engineers but their automotive counterparts too. After all, that kind of absolute faith in your machine is something every keen driver aspires to. But how do you design such a thing? How do you know a particular set of components will behave in the way you intend?

The answer lies in finding the perfect balance between power and control, between the pleasure of invigorating performance and the reassurance of vigilant yet barely perceptible safety systems. Rather like one of those mid-air manoeuvres, it's a feat that looks easy when done well but, in fact, it requires exceptional expertise and precision. To appreciate it, simply put the C-Class Coupé through its paces. We think you'll find it an uplifting experience.



- | | | | |
|---|--|--|--|
| <p>17 BlueEFFICIENCY</p> <p>18 Efficiency in the C-Class Coupé</p> <p>19 Diesel engines
4-cylinder diesel engines</p> <p>21 Petrol engines
4-cylinder petrol engines
V6 petrol engine</p> <p>23 Transmissions
6-speed manual transmission
7G-Tronic Plus</p> <p>24 Suspension
Agility Control suspension
Dynamic Handling Package with sport mode</p> | <p>25 Safer driving
Attention Assist
Intelligent Light System
LED tail lights and adaptive brake lights
Driving Assistance Package</p> <p>27 Anticipating danger
Pre-Safe® Brake and BAS Plus
Pre-Safe® system</p> <p>28 Protecting occupants
Neck-Pro active head restraints
Airbags
Active Bonnet</p> | <p>29 Multimedia systems
COMAND Online
Harman Kardon® Logic 7® surround sound system
Audio 20
Becker® Map Pilot</p> <p>31 Electronic assistants
Speed Limit Assist
Reversing camera
Parktronic with Advanced Parking Guidance
Lane-Tracking Package</p> <p>33 Seats
Coupé-specific front seats
Individual rear seats
Memory Package</p> | <p>35 C 63 AMG exterior</p> <p>37 C 63 AMG interior</p> <p>39 C 63 AMG technology
AMG 6.3-litre V8
AMG sports suspension
AMG Speedshift MCT 7-speed sports transmission</p> <p>41 AMG Performance Studio</p> |
|---|--|--|--|

C-Class Coupé in detail



43 **Standard equipment**

44 **Optional extras**

45 **AMG Sport model**

49 **Upholstery and trim**

55 **Alloy wheels**

Standard wheels

Optional wheels

AMG wheels

56 **Retailer-fit accessories**

57 **Services**

Test drive

Mercedes-Benz Finance
and Insurance

Factory Collection

Interactive Owner's Manual

Roadside Assistance

Mercedes-Benz World

59 **Dimensions**

60 **Technical data**

62 **Paint finishes**



BlueEFFICIENCY – technology for more efficient driving



Our comprehensive BlueEFFICIENCY measures have already brought significant cuts in fuel consumption to many current Mercedes-Benz models, helping to lower both their CO₂ emissions and their running costs. What's more, we are continuing to develop new environmentally friendly technologies that will reduce emissions even further and help to make motoring more sustainable in the long term.

BlueEFFICIENCY – the Mercedes-Benz efficiency drive. BlueEFFICIENCY models feature a range of measures that can considerably reduce fuel consumption and CO₂ emissions. They include aerodynamic optimisation, low-resistance tyres and intelligent energy management technologies such as the ECO start/stop function, which comes as standard on an increasing number of models. Many of our model ranges also now feature new BlueDIRECT engines. Their innovative direct petrol injection system delivers significantly more power, yet also helps to cut fuel consumption by up to 25%.

BlueTEC – cleaner diesel power. BlueTEC is our cleanest diesel technology to date. Its combination of advanced common-rail direct injection, optimised combustion and modular emissions control systems reduces particulate levels by up to 95% and removes up to 90% of nitrogen oxides, leaving little but water, harmless nitrogen and the satisfaction of knowing you've done your bit for the environment.

HYBRID and BlueTEC HYBRID – the future of internal combustion. The next stage in our efficiency drive, hybrid powertrains will bring new levels of fuel efficiency and emissions reduction to tomorrow's Mercedes-Benz passenger cars. The diesel equivalent, BlueTEC HYBRID, combines the benefits of hybrid drive with the clean-burn technology of BlueTEC.

Innovative designs, the new direction: E-Cell and F-Cell. We have developed two drivetrains that produce zero local emissions, both of which have been in limited production since 2010. The B-Class F-Cell¹ uses a hydrogen fuel cell to drive its electric motor, while the A-Class E-Cell¹ is powered solely by twin lithium-ion batteries.

Design for Environment. Our environmental philosophy is not just about in-car technologies. It also involves taking the entire lifecycle of each vehicle into account, from its initial planning to its end-of-life recycling. We apply the same approach to the building and maintenance of new factories too, saving energy, avoiding harmful emissions and making increasing use of renewable resources. In addition, Mercedes-Benz is involved in the development of alternative fuels and conducts research in the field of bionics.

For more information about what BlueEFFICIENCY can do for you, please visit www.mercedes-benz.co.uk/blueefficiency



Efficiency in the C-Class Coupé

With our BlueEFFICIENCY measures, we are helping to reduce fuel consumption and CO₂ emissions across the Mercedes-Benz passenger car range. They come as standard on all C-Class Coupé models.



The BlueEFFICIENCY measures for the C-Class Coupé include intelligent power-managed units and optimised aerodynamics. In addition, fuel consumption is further reduced by our ECO start/stop function, which almost imperceptibly cuts the engine when queuing or coming to a standstill.

- 1 Radiator shutter
- 2 Enhanced aerodynamics
- 3 Weight savings
- 4 Optimised engines
- 5 Intelligent energy management
- 6 ECO start/stop function
- 7 Driver information that encourages fuel-efficient driving style
- 8 Tyres designed for lower rolling resistance
- 9 Energy-saving fuel pump (diesel models) and power steering pump
- 10 Air-conditioning compressor only active on demand

Diesel engines

The diesel engines for the C-Class Coupé are efficient, refined and powerful, offering significantly higher outputs and lower fuel consumption than conventional diesel units.

4-cylinder diesel engines. Impressive performance is achieved courtesy of a range of technical innovations, resulting in figures of 170 hp (125 kW) for the

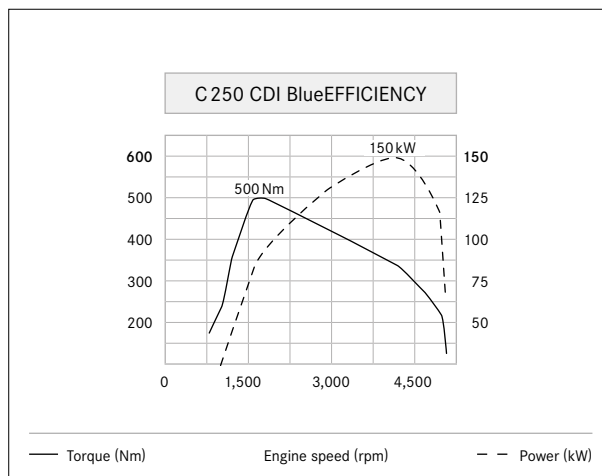

With high levels of torque even at low engine speeds, the C 250 CDI BlueEFFICIENCY delivers instant acceleration

C 220 CDI BlueEFFICIENCY and 204 hp (150 kW) for the C 250 CDI BlueEFFICIENCY. The high-pressure injection system injects fuel at up to 2,000 bar and sends only the required amount of fuel into the combustion chambers. The chambers themselves have been optimised to ensure fuel burns as cleanly and efficiently as possible, while the intelligent alternator management system means the alternator is only active when needed, reducing the load on the engine. There are also efficient twin turbochargers and twin balancer shafts that keep the engine running smoothly at all times.

Both 4-cylinder diesel models come with the ECO start/stop function and meet the Euro 5 standard for exhaust emissions.



The 4-cylinder engine for the C 220 CDI BlueEFFICIENCY features advanced Mercedes-Benz diesel technology



Petrol engines

Enjoyment and efficiency can go hand in hand – as the C-Class Coupé's petrol engines prove. Both the 4-cylinder models and V6 variant deliver exceptionally refined performance and impressively low fuel consumption.

4-cylinder petrol engines. Our latest-generation petrol engines offer both increased power and reduced fuel consumption. It's a feat they achieve thanks to

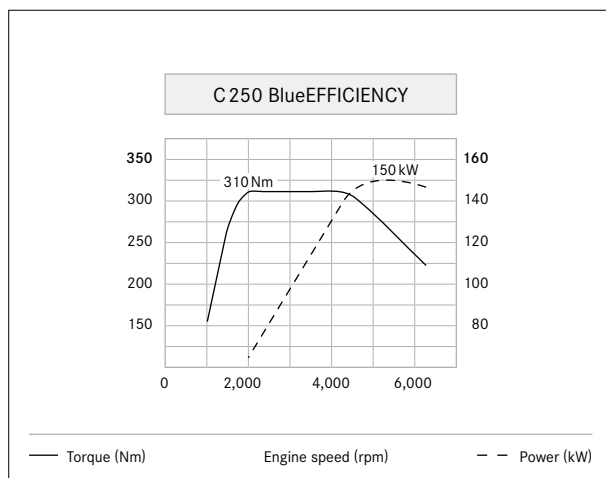

The power and torque curves are impressive, the fuel consumption figures even more so

advanced engine technology and BlueEFFICIENCY measures such as the ECO start/stop function.

The result is efficient performance and impressive acceleration. Fitted with the optional 7G-Tronic Plus automatic transmission, the C 180 BlueEFFICIENCY accelerates from 0 to 62 mph in 8.9 seconds and goes on to reach a top speed of 139 mph, while the C 250 BlueEFFICIENCY dispatches the same sprint in just 7.2 seconds and continues all the way up to a maximum 149 mph.

V6 petrol engine. Powerful, economical and clean, the C 350 BlueEFFICIENCY perfectly embodies the virtues of our new-generation petrol engines. Despite delivering 306 hp (225 kW) and accelerating from 0 to 62 mph in just 6.0 seconds, it achieves a remarkably frugal 40.4 mpg on the combined cycle. What's more, its peak torque of 370 Nm is available across a broad rev range,

ensuring instant responses whatever the situation or speed.

The key to this impressive blend of efficiency and performance is our latest-generation direct petrol injection system. It features spray-guided combustion and highly precise piezo injectors and works in conjunction with continuously variable camshaft control, which ensures precisely the right amount of fuel is used for any given situation.



The C350 BlueEFFICIENCY combines excellent performance with efficient use of fuel



Transmissions

The transmissions for the C-Class Coupé ensure optimum performance whatever the situation or engine speed.

6-speed manual transmission. The 6-speed manual transmission combines impressive efficiency with a sporty feel. The ratios are ideally matched to the engine and the short, precise shift throws ensure every gear change is a pleasure. Manual C-Class Coupé models are equipped with a shift point indicator and current fuel consumption display that help you to optimise efficiency and reduce CO₂ emissions. The standard ECO start/stop function, meanwhile, helps to achieve further fuel-savings, cutting the engine automatically when stationary or coming to a standstill, and restarting it as soon as you touch the accelerator or depress the clutch.

7G-Tronic Plus. 7G-Tronic Plus is the latest version of our 7-speed automatic transmission. It helps to improve fuel consumption by ensuring the engine is always operating at the optimum speed, yet delivers faster, smoother shifts and better acceleration too, even skipping gears in kickdown for more rapid overtaking. In addition, 7G-Tronic Plus allows you to switch between comfort and sport modes as the mood takes you.

With the AMG Sport model or the optional Dynamic Handling Package, there's also a manual mode that lets you enjoy even sportier gear changes via the steering wheel gear shift paddles. 7G-Tronic Plus comes as standard on the C 250 BlueEFFICIENCY and C 350 BlueEFFICIENCY and is available as an option on all other models.



7G-Tronic Plus: the result of more than 50 years' experience in automatic transmission technology



Suspension

Intelligent suspension technology enables the C-Class Coupé to maximise comfort or agility as the situation requires, giving you optimum driving enjoyment at all times.

Agility Control suspension (standard). The Agility Control suspension with Adaptive Damping System tailors the ride and handling to suit the road surface and driving style. If the shocks are comparatively small, a valve reduces damping levels at each wheel in order to enhance ride comfort. If the shocks are larger, the damping is increased, ensuring optimum stability.

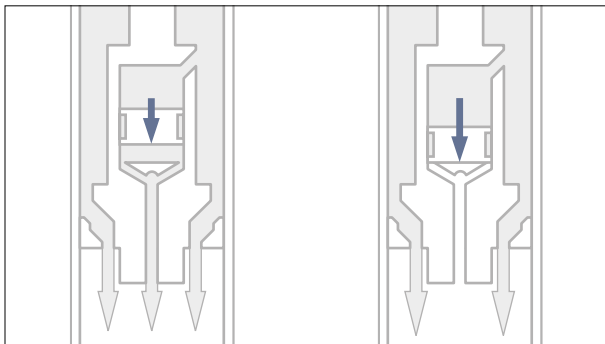

Agile handling and high levels of comfort: the Agility Control suspension adjusts the damping as you drive

Dynamic Handling Package with sport mode (optional; not available on C 180 BlueEFFICIENCY). The Dynamic Handling Package offers even higher levels of agility and enjoyment. It adds an electronically controlled damping system that continuously adjusts the damping levels at each wheel to the situation and surface, plus a sport mode that gives you firmer damper settings and faster throttle responses.



The optional Dynamic Handling Package makes for an even sportier drive



Safer driving

The C-Class Coupé comes with a host of safety features that help to avoid danger and make for a more relaxing journey.

Attention Assist (standard). If it detects signs of tiredness, Attention Assist alerts the driver via visual and acoustic warnings and recommends taking a break. It monitors driver behaviour via an array of sensors and registers unexpected changes that may indicate drowsiness or concentration lapses.



Attention Assist can detect the onset of tiredness and alert you to the need for a break

Intelligent Light System with Adaptive High Beam Assist and LED daytime running lights (standard). The Intelligent Light System comprises a variety of modes and functions: country mode, motorway mode, fog mode, cornering light function and the Active Light System for better visibility in bends. It also includes LED daytime running lights and Adaptive High Beam Assist, which maximises the headlamps' range when no other road users are within sight, then automatically

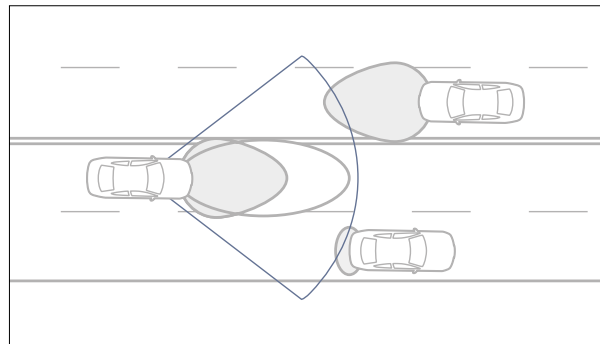

The Intelligent Light System automatically optimises visibility in a range of different situations

dips the beams if the lights of an oncoming vehicle are detected.

LED tail lights and adaptive brake lights (standard). During emergency braking, the adaptive brake lights flash 5.5 times per second, sending a clear warning to those behind. If the car is brought to a standstill from a speed of more than 44 mph, the hazard warning lights are also switched on automatically.



The LED tail lights and adaptive brake lights increase your visibility and safety



Driving Assistance Package (optional). This option package combines radar-assisted cruise control, Active Blind Spot Assist and Active Lane-Keeping Assist. At speeds of between 0 and approx. 125 mph, Distronic Plus can help you to maintain the required distance from the vehicle in front. It applies the brakes automatically (bringing the car to a standstill if necessary) and accelerates again once the situation allows. In addition, the integrated Brake Assist (BAS Plus)

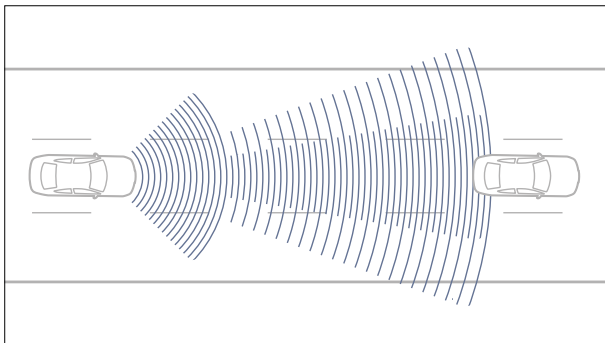

Distronic Plus can bring the car to a standstill and get you moving again automatically – a boon in stop/start driving

recognises emergency braking and, if the driver hasn't applied the brakes firmly enough, automatically increases the braking pressure as required. Thanks to Pre-Safe® Brake, the C-Class Coupé can even initiate an automatic emergency stop approx. 0.6 seconds before an imminent collision, thereby reducing the severity of the impact.

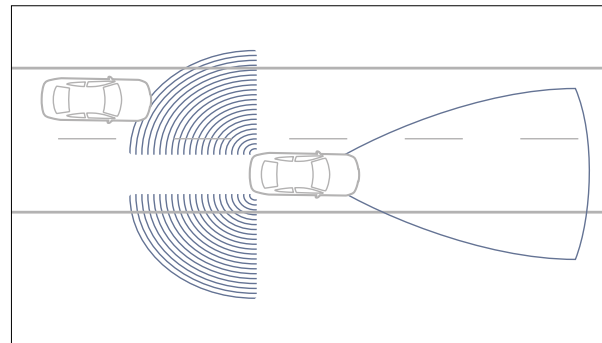

Active Blind Spot Assist and Active Lane-Keeping Assist help you to stay safe in multi-lane driving

Active Blind Spot Assist enhances safety when turning or changing lanes. If it detects the presence of a vehicle in one of your blind spots, it alerts you via a warning triangle in the corresponding exterior mirror. Should you proceed with the manoeuvre, the system can automatically apply gentle braking in order to avoid a collision.

Active Lane-Keeping Assist, meanwhile, reads lane markings by recognising contrasts on the road surface in front of the car. Should the car cross these markings unintentionally, it alerts the driver by gently vibrating the steering wheel. If there's no reaction, the system can apply the required braking so as to prevent the car from leaving its lane. By also monitoring your driving and recognising motions typically associated with involuntary changes of course, Active Lane-Keeping Assist is able to reliably differentiate them from intentional lane changes.



Anticipating danger

Sometimes critical situations prove unavoidable. Thankfully, the C-Class Coupé is equipped with anticipatory safety systems that can reduce the severity of an impact and even help you avoid an accident altogether.

Pre-Safe® Brake and BAS Plus (part of optional Driving Assistance Package). If it detects the risk of a collision, Pre-Safe® Brake alerts the driver via visual and audible warnings. At the same time, BAS Plus assesses the brake force required in order to avoid an impact. If the driver applies the brakes but uses insufficient force, BAS Plus automatically raises the braking pressure to a level that exploits the remaining stopping distance to the full, thereby also lessening the likelihood of a shunt from behind.

Should the driver fail to react to Pre-Safe® Brake's warning signals, it slows the car automatically, providing a further warning, and triggers a range of Pre-Safe® measures. If the driver still doesn't respond,

the system then initiates autonomous emergency braking, enabling the speed and severity of any impact to be significantly reduced.

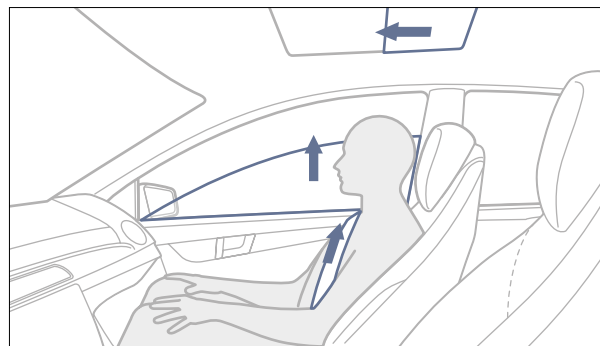

The Pre-Safe® system can detect critical situations and take anticipatory measures to enhance occupant protection

Pre-Safe® system (standard). If it detects a probable accident scenario, Pre-Safe® can take a range of anticipatory measures to reduce the risk of injury to the occupants. These include activating the front seat belt tensioners, automatically closing the windows and, if the optional Memory Package is fitted, moving the front passenger seat to a more favourable position. Airbags (standard). As well as front airbags and front sidebags, the C-Class Coupé is fitted with windowbags, pelvisbags and a driver's side kneebag that help to further reduce the risk of injury. Sidebags for rear seat occupants are available as an option.

Protecting occupants

The C-Class Coupé optimises safety even if an accident proves unavoidable, initiating measures during and immediately prior to an impact that can reduce the risk of injury to its occupants.

Neck-Pro active head restraints (standard). The Neck-Pro front head restraints help to reduce the risk of whiplash injuries. Within milliseconds of a rear-end

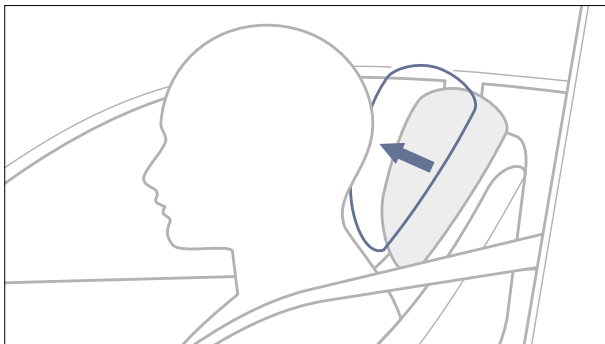

The Neck-Pro active head restraints can help to avoid whiplash injuries in rear-end collisions

impact, they automatically move forwards and upwards, enabling them to support the head sooner.

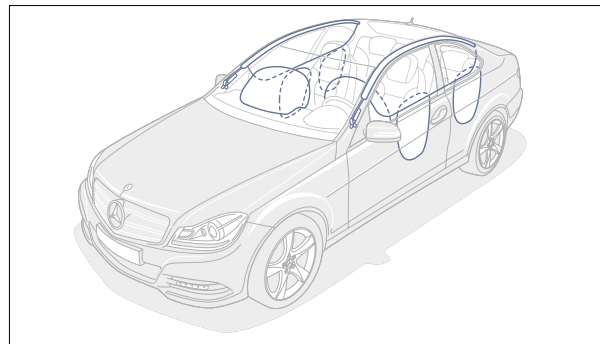

The rigid passenger cell, front and rear crumple zones and intelligent restraint systems provide optimum protection in the event of an impact

Airbags (standard). As well as front airbags and front sidebags, the C-Class Coupé is fitted with windowbags, pelvisbags and a driver's side kneebag that help to further reduce the risk of injury. Sidebags for rear seat occupants are available as an option.

Active Bonnet (standard). If a pedestrian or cyclist hits the front of the C-Class Coupé, the rear of the Active Bonnet is automatically raised by 5 cm. This creates extra deformation space, helping to reduce the risk of injury to more vulnerable road users.



Multimedia systems

With its high-quality multimedia and navigation systems, the C-Class Coupé helps you to reach your destination as swiftly as possible – and keeps you entertained all the way.



The large TFT display presents maps, videos or online content in high resolution

COMAND Online (optional). The COMAND Online multimedia system combines hard disk drive navigation with in-car internet access and a wide range of entertainment features. These include speed-sensitive volume adjustment, a music library with 10 GB of storage space for audio files and a DVD drive that plays CDs, MP3s, and video or audio DVDs. It also enables you to connect a variety of external devices and storage media – via USB port, Media Interface, SD memory card slot or Bluetooth® interface – and lets you access the internet as well as a variety of online Mercedes-Benz services (internet-enabled mobile phone required). Maps and menus are presented on a high-resolution 7-inch colour display, and all key functions can be operated either via the central controller, from the multi-function steering wheel or using Linguatronic voice control. Three years of map updates are offered free of charge.



Harman Kardon® Logic 7® surround sound system (optional). With its 12 high-performance speakers and Logic 7® multi-channel spatial sound technology, this 450-watt surround sound system makes every journey a listening experience to remember. In addition, it comes with speed-sensitive volume adjustment that adjusts the audio output as you drive.



The Harman Kardon® Logic 7® surround sound system offers a truly first-class listening experience

Audio 20 (standard). The Audio 20 system features a radio, a 6-disc CD changer with MP3 playback, aux-in and USB ports, and a Bluetooth® interface for hands-free mobile telephony. It also comes with a 5.8-inch TFT display and can be operated remotely via the multi-function steering wheel. A DAB digital radio tuner is included as standard on the C-Class Coupé.



The Audio 20 system features eight carefully combined speakers that deliver excellent sound

Becker® Map Pilot navigation system (optional). With the Becker® Map Pilot navigation system, you'll always reach your destination as safely and quickly as possible. Installed in the glove compartment, the Map Pilot can be integrated with Audio 20 CD system's central controller and display and tailored to your needs by downloading additional functions and map data.



Electronic assistants

The C-Class Coupé is available with electronic assistants that enhance safety and convenience in a range of situations. They can help you to avoid danger during lane changes, lend a hand in low-speed manoeuvres – and even keep an eye on the speed limit for you.



Speed Limit Assist even recognises and displays temporary speed restrictions

Speed Limit Assist (fitted with the optional COMAND Online system). Speed Limit Assist reads speed limit signs and displays the permitted maximum speed in the instrument panel and on the COMAND Online navigation screen until the limit changes. Its front-mounted camera detects round speed limit warnings, both on roadside signs and on overhead gantries, and is particularly useful in areas where the speed limit varies or when passing through roadworks. To help identify the limit correctly, it compares speed limit signs with map data from the navigation system, enabling it to recognise when you are entering or leaving built-up areas for instance.



Reversing camera (optional; only in conjunction with COMAND Online). This rear-mounted camera makes for safer and easier parking manoeuvres. Activated automatically as soon as the driver engages reverse, it captures the area immediately behind the car and enables you to see the image on the COMAND Online display.



The reversing camera makes for easier manoeuvring in tight spaces

Parktronic with Advanced Parking Guidance (standard). Parktronic uses the sonar principle to help you avoid low-speed knocks during parking manoeuvres. It sends out ultrasound signals that reflect off other objects and are picked up by sensors in the front and rear bumpers. The system then processes this information and calculates the size of the gap to the front and rear, enabling it to alert you via acoustic and visual warnings as you approach the vehicle or object.



At speeds of up to 22 mph, Advanced Parking Guidance can automatically measure the length of parallel parking spaces

Lane-Tracking Package (optional). This option package combines two assistants that enhance safety in multi-lane driving. Lane-Keeping Assist detects white road markings and warns you via subtle vibrations of the steering wheel should you unintentionally stray out of lane. At speeds of approximately 20 mph or above, Blind Spot Assist uses twin radar sensors to monitor the hard-to-see areas either side of the rear, enabling it to recognise and warn you of potentially dangerous lane changes.



Fitted as part of the optional Lane-Tracking Package, Blind Spot Assist warns of potentially dangerous lane changes



Seats

The C-Class Coupé features coupé-specific front seats, individual rear seats and integral head restraints all round. Its eye-catching seats not only look the part, they also offer excellent ergonomics and high levels of support even in sporty driving.



Coupé-specific front seats lend the C-Class Coupé cabin a sporty look and feel

Coupé-specific front seats. For the driver and front seat passenger, the C-Class Coupé offers ergonomically designed coupé-specific seats. They come upholstered in a combination of cloth and Artico artificial leather, with genuine leather available as an option, and have electric seat height and backrest angle adjustment as standard. Heated or comfort-ventilated seats are also available as an option.

Individual rear seats with integral head restraints. Those in the rear benefit from ergonomic, individually sculpted seats with integral head restraints. They echo the sporty style of the coupé-specific front seats and come with an asymmetric split/fold mechanism. Also fitted as standard is the Easy-Entry system, which provides more convenient access to the rear seat accommodation.





The standard Easy-Entry system facilitates access to the rear, sliding the front seats all the way forward when released

Memory Package (optional). The optional Memory Package ensures you can always find your preferred driving position quickly and easily, even if your C-Class Coupé is regularly driven by someone else. It allows up to three different driver's seat, steering column and exterior mirror positions to be stored and recalled at any time.



With the optional Memory Package, your preferred driving position can be restored at the touch of a button



C 63 AMG exterior

For the first time ever, the fastest C-Class is also available in coupé form. The C 63 AMG Coupé combines the race-honed technology of its four-door cousins with a dramatic and highly individual style. Its sporty coupé lines are made even more eye-catching by the AMG grille with single chrome louvre, an AMG-specific bonnet with powerdomes, and AMG bodystyling comprising front and rear aprons plus side skirts. The AMG sports exhaust system's two sets of twin chromed tailpipes provide a further clue to the power of this exhilarating coupé, while AMG-specific daytime running lights and 18" 5-spoke AMG alloy wheels in burnished Titanium Grey also come as standard (19" AMG multi-spoke wheels in Titanium Grey or Matt Black are available as an option).

EXTERIOR

18" AMG 5-twin-spoke alloy wheels with burnished Titanium Grey finish

AMG bodystyling, comprising front apron with side air vents and gloss black cross-bar, side skirts and diffuser-style rear apron

AMG spoiler lip on boot lid

AMG high-performance braking system with 360 × 36 mm front brake discs and 330 × 26 mm rear discs

LED tail lights

Panoramic sunroof

Wider front wings with '6.3 AMG' badges



Image shows optional 19" AMG alloy wheels





Image shows optional 19" AMG multi-spoke alloy wheels in Matt Black



C 63 AMG interior

Stylish, sporty and highly exclusive, the interior of the C 63 AMG Coupé feels instantly special. Its supportive AMG sports seats are upholstered in black single- or two-tone *designo* leather. The flat-rimmed AMG Performance steering wheel features tactile nappa leather trim and aluminium gear shift paddles, and there's an ergonomic AMG-specific instrument panel with colour display and AMG start-up screen. Eye-catching AMG door sill strips and brushed stainless steel sports pedals also come as standard (carbon-fibre trim is available as an option).

INTERIOR

Aluminium Trim

AMG door sill strips in brushed stainless steel

AMG instrument panel with high-resolution 4.5-inch color display, including Racetimer and AMG start-up screen

AMG sports parameter steering

AMG sports seats with *designo* Black leather upholstery

Attention Assist

Brushed stainless steel sports pedals with rubber studs

COMAND Online system with Media Interface

DAB digital radio tuner

Flat-rimmed AMG Performance steering wheel with nappa leather trim and aluminium gear shift paddles

Rotary switch for transmission modes and Race Start function



Image shows optional COMAND Online and optional carbon-fibre trim





C 63 AMG technology

The AMG 6.3-litre V8 delivers exceptional power, the sports transmission and suspension help you exploit it to the full – and let you switch between performance- and comfort-biased set-ups.

AMG 6.3-litre V8. Under the bonnet of the C 63 AMG is a naturally aspirated V8 equipped with track-honed racing technologies. These include variable camshaft timing, four valves per cylinder, an exceptionally rigid aluminium crankcase and a special low-friction coating for the cylinder contact surfaces. For optimum cylinder charging, this high-tech engine also features vertically arranged intake and exhaust ports plus a magnesium variable intake manifold with twin throttle flaps. The result is free-revving performance, exceptional pulling power and instant acceleration at all speeds. The C 63 AMG delivers 457 hp (336 kW) at 6,800 rpm, plus 600 Nm of torque at 5,000 rpm, with in excess of 500 Nm available all the way from 2,000 to 6,250 rpm. The AMG Performance Package creates an even more powerful C 63 AMG: it increases output to 487 hp (358 kW), enabling it to accelerate from 0 to 62 mph in a breathtaking 4.5 seconds (4.4 seconds with Performance Package).

AMG sports suspension. The AMG sports suspension offers outstanding agility and exceptional lateral acceleration potential. Together with the low-profile tyres, wide front track, AMG sports parameter steering and three-stage ESP,[®] it ensures exceptional vehicle dynamics and an exhilarating driving experience. The triple-link front suspension, firm springing and gas pressure dampers guarantee optimum roadholding and excellent body control even at the limit, yet the ride remains as comfortable as you'd expect from a Mercedes, even on longer journeys. The AMG sports parameter steering features a more direct ratio that gives greater steering precision and allows for even higher cornering speeds, while the Electronic Stability Programme (ESP[®]) is also tailored to the C 63 AMG's high-performance needs. It lets you determine the level of ESP[®] support yourself, allowing you to switch between 'on', 'off' and 'sport' and displaying the current setting in the instrument panel.

For exceptional stopping power, an AMG high-performance braking system featuring large, internally ventilated and cross-drilled discs is fitted as standard. It ensures short braking distances and enables the level of brake force to be precisely controlled. The AMG sports parameter steering, meanwhile, is now more direct than ever and offers extra accuracy at high speeds.

As an option, the C 63 AMG Coupé can be fitted with AMG Performance suspension. Its tauter spring and damper settings make for even faster handling responses and a thoroughly focused feel.



AMG Speedshift MCT 7-speed sports transmission.

Equipped with AMG aluminium steering wheel shift paddles, four driving modes and a Race Start function, the C 63 AMG's 7-speed sports transmission maximises performance yet delivers high levels of efficiency.

The 'S' (Sport), 'S+' (Sport Plus), 'C' (Comfort) and 'M' (Manual) modes each offer different shift characteristics and speeds: gear changes in Sport and Sport Plus modes are around 20% and 40% faster respectively than in Comfort mode, while Manual mode is approximately 50% faster, with shift times of just 100 milliseconds. The transmission also offers automatic throttle-blipping on downshifts. This not only produces a satisfyingly sporty sound, it also helps to reduce load transfer, especially when braking into bends.



The AMG Speedshift MCT 7-speed sports transmission offers a choice of modes that let you enhance comfort or maximise driving pleasure

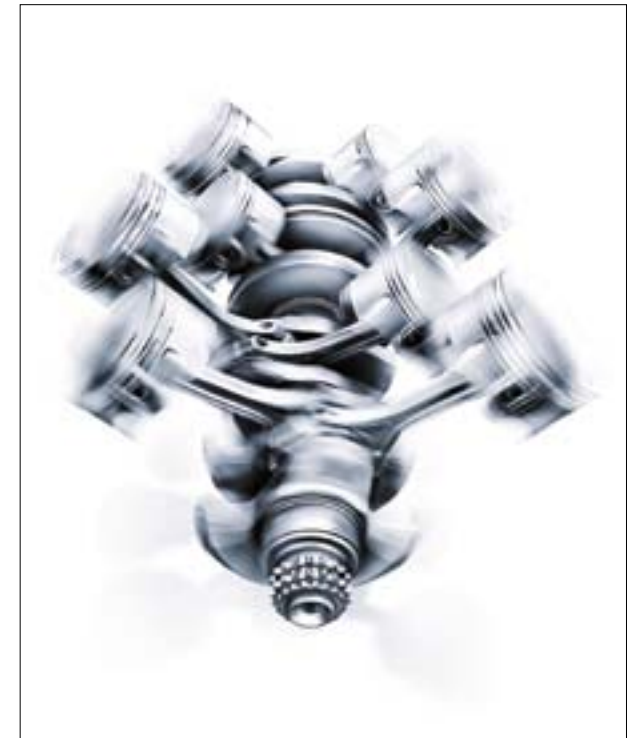

Track-honed technology helps the AMG 6.3-litre V8 to deliver exhilarating performance



AMG Performance Studio

For an even sportier C 63 AMG, simply add options from the AMG Performance Studio. They include the AMG Performance Package Plus, which comprises an upgraded output of 487 hp (358 kW), a Titanium Grey variable intake manifold, AMG high-performance composite front brake discs, red brake calipers, an AMG carbon-fibre boot lid spoiler and an AMG Performance steering wheel with nappa leather and Alcantara® trim. Also available is the AMG Driver's Package, which raises the electronically limited top speed and includes participation at an AMG 'Power & Passion' driving event. The AMG Performance Studio can even fulfil specific customer requests – for everything from personalised vehicles to genuine one-offs.

AMG PERFORMANCE STUDIO

18" AMG 5-spoke alloy wheels in Titanium Grey or 19" AMG multi-spoke alloy wheels in Titanium Grey or Matt Black

AMG Driver's Package

AMG door sill strips with white LED backlighting

AMG Exterior Carbon-fibre Trim Package, comprising carbon-fibre boot lid spoiler and exterior mirror housings

AMG carbon-fibre interior trim

AMG locking rear differential





Standard equipment | Selection



Automatic climate control



3-spoke 12-button multi-function steering wheel with nappa leather trim, perforated in central grip area



Coupé-specific front seats



USB port and aux-in socket



LED tail lights



Audio 20 radio with integrated CD changer



ECO start/stop function



Optional extras | Selection



Privacy glass – tinted rear side windows and rear windscreen



COMAND Online multimedia system with Linguatronic voice control



Media Interface



Panoramic glass sunroof



Lighting Package



Active Blind Spot Assist



C-Class Coupé AMG Sport

The AMG Sport makes for an even more striking and involving C-Class Coupé. Its standard sports suspension and sports parameter steering further increase your driving enjoyment, while the AMG styling enhancements add extra muscularity to the exterior. They include an AMG front apron, side skirts, a diffusor-style rear apron and 18" AMG 7-spoke alloy wheels.



Image shows optional panoramic sunroof



EXTERIOR

18" AMG 7-spoke alloy wheels

AMG bodystyling comprising front and rear aprons and side skirts

Cross-drilled front brake discs plus calipers with 'Mercedes-Benz' lettering

Lowered sports suspension

Parktronic, front and rear, with Advanced Parking Guidance

Sports parameter steering





Image shows optional panoramic sunroof, Driving Assistance Package and leather interior



AMG Sport interior

The AMG Sport interior not only looks more dynamic, it feels it too. The flat-bottomed 3-spoke multi-function sports steering wheel is tactile and grippy, the steering wheel gear shift paddles (automatic models only) offer racing-style gear changes, and the sports parameter steering further enhances the agile handling. Other interior highlights include dark brushed aluminium trim, stainless steel sports pedals, a black roof lining and AMG floor mats, and there's also a large 4.5-inch colour display for the instrument panel.



Image shows optional leather interior, comfort-ventilated seats, Dynamic Handling Package, COMAND Online and Harman Kardon® Logic7® surround sound system

INTERIOR

3-spoke 12-button multi-function sports steering wheel with flat-bottomed rim and nappa leather trim, perforated in central grip area

AMG instrument panel with high-resolution 4.5-inch color display, including Racetimer and AMG start-up screen

Attention Assist

Black floor mats with AMG insignia

Black roof lining

DAB digital radio tuner and USB port

Dark brushed aluminium trim

Sports pedals in brushed stainless steel with rubber studs

Steering wheel gear shift paddles (with automatic transmission)





Image shows optional leather interior, comfort-ventilated seats, Dynamic Handling Package, COMAND Online and Harman Kardon® Logic7® surround sound system



Upholstery and trim



The standard Black interior with Artico artificial leather/cloth upholstery features Black seats, a black dashboard, black door trims and a black load compartment cover. The A-, B- and C-pillar trims and fabric roof lining are in black. There's additional dark brushed aluminium trim for the dashboard, doors and centre console, with High-Gloss Black or matt-finish Brown Ash wood available as an option.



721

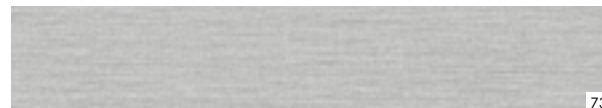

739

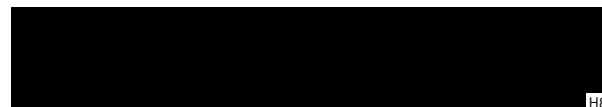

H80



H06

BLACK

721 Artico artificial leather/cloth

TRIM

739 Dark brushed aluminium

H80 High-Gloss Black¹

H06 Brown Ash, matt finish¹

¹Optional

Interior image shows optional wood trim





The standard Alpaca Grey interior with Artico artificial leather/cloth upholstery features Alpaca Grey seats, a two-tone black and Alpaca Grey dashboard, a black load compartment cover and a black fabric roof lining. There's also additional dark brushed aluminium trim for the dashboard, doors and centre console, with High-Gloss Black trim or matt-finish Brown Ash wood available as an option.

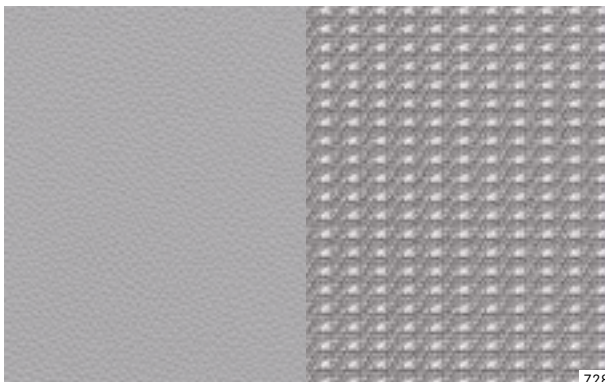

Interior image shows optional wood trim

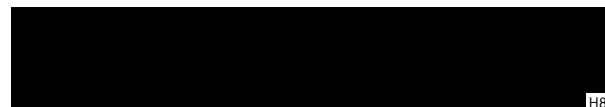
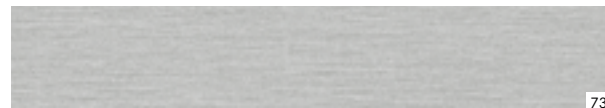

ALPACA GREY

728 Artico artificial leather/cloth

TRIM

739 Dark brushed aluminium

H80 High-Gloss Black¹

H06 Brown Ash, matt finish¹

¹Optional





The optional Black interior with leather upholstery features Black leather seats with Dark Alpaca Grey top-stitching, black doors and dashboard. The A-, B- and C-pillar trims, fabric roof lining and load compartment cover are all in black. There's additional dark brushed aluminium trim for the dashboard, doors and centre console, with High-Gloss Black trim or matt-finish Brown Ash wood available as an option.

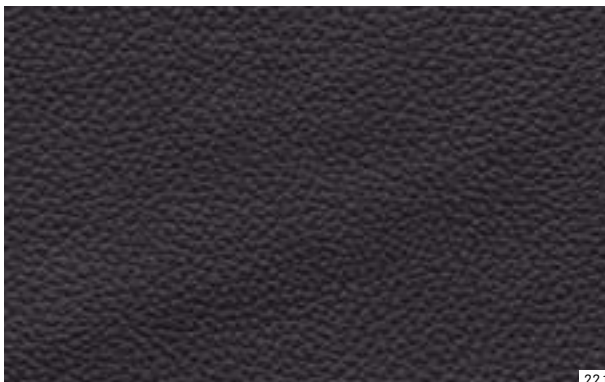

221



739



H80



H06

BLACK
221 Leather¹

TRIM

739 Dark brushed aluminium

H80 High-Gloss Black¹H06 Brown Ash, matt finish¹¹Optional



The optional Alpaca Grey interior with leather upholstery features Alpaca Grey leather seats with Dark Alpaca Grey top-stitching, Alpaca Grey doors and a two-tone Black and Alpaca Grey dashboard. The A-, B- and C-pillar trims, fabric roof lining and load compartment cover are all in black. There's additional dark brushed aluminium trim for the dashboard, doors and centre console, with High-Gloss Black trim or matt-finish Brown Ash wood available as an option.

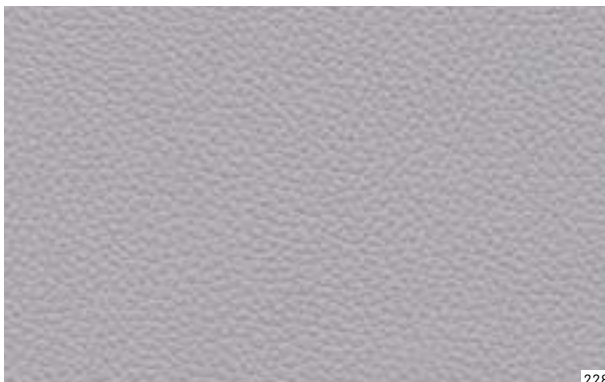

228



739

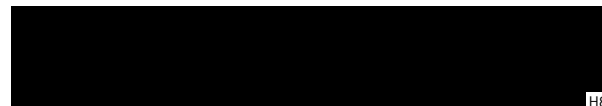

H80



H06

ALPACA GREY
228 Leather¹

TRIM

739 Dark brushed aluminium

H80 High-Gloss Black¹H06 Brown Ash, matt finish¹¹Optional



The optional Sahara Beige interior with leather upholstery features Sahara Beige leather seats and top-stitching, with matching Sahara Beige door trim. The dashboard, fabric roof lining and load compartment cover are all in black, as are the A-, B- and C-pillar trims. There's additional dark brushed aluminium trim for the dashboard, doors and centre console, with High-Gloss Black trim or matt-finish Brown Ash wood available as an option.

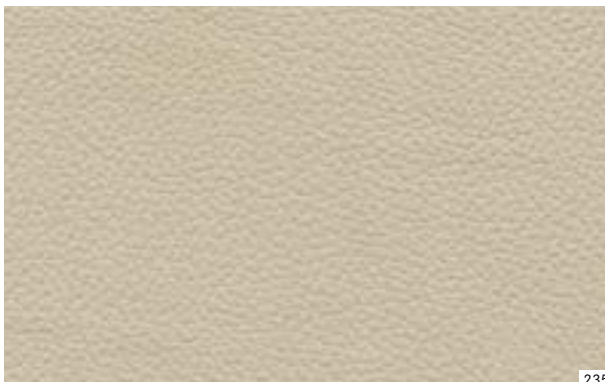

235

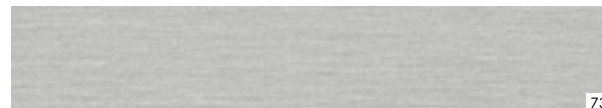

739

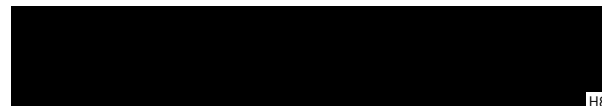

H80



H06

SAHARA BEIGE

235 Leather¹

TRIM

739 Dark brushed aluminium

H80 High-Gloss Black¹H06 Brown Ash, matt finish¹¹Optional



The optional Flamenco Red interior with leather upholstery features Flamenco Red leather seats with black top-stitching and matching Flamenco Red door trim. The dashboard, fabric roof lining and load compartment cover are all in black, as are the A-, B- and C-pillar trims. There's additional dark brushed aluminium trim for the dashboard, doors and centre console, with High-Gloss Black trim or matt-finish Brown Ash wood available as an option.



237

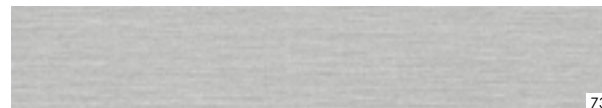

739

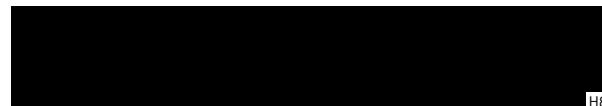

H80



H06

FLAMENCO RED

237 Leather¹

TRIM

739 Dark brushed aluminium

H80 High-Gloss Black¹H06 Brown Ash, matt finish¹¹Optional

Alloy wheels



18" AMG 7-spoke alloy wheels (standard on AMG Sport, code 782)



18" AMG 5-twin-spoke alloy wheels, with burnished Titanium Grey finish (standard on C 63 AMG, code 795)



19" AMG multi-spoke alloy wheels, with burnished Titanium Grey finish (optional on C 63 AMG, code 788)



18" AMG 5-twin-spoke alloy wheels (optional on AMG Sport, code 786)



18" AMG 5-spoke alloy wheels, with burnished Titanium Grey finish (optional on C 63 AMG, code 790)



19" AMG multi-spoke alloy wheels, Matt Black finish with burnished rim (optional for C 63 AMG, code 797)



Retailer-fit accessories

A Mercedes-Benz is not just a car, it's a travel companion that can be tailored to your needs – with our wide range of Retailer-fit accessories.

→ www.mercedes-benz.co.uk/accessories

Our Retailer-fit accessories enable you to create the perfect C-Class Coupé for your lifestyle. If you often need to transport lots of luggage or sports gear, you'll find the ideal solution in our range of roof racks and boxes. The boxes come in two different sizes: the family version holds 450 litres while the sports box swallows 330 litres. Both open and close on either side and can be mounted on our Retailer-fit roof bars for safe and secure transportation. Also available are a luggage set and ski bags designed specifically to fit the roof boxes.



Roof bars with 'Comfort' ski and snowboard rack

For an exclusive welcome every time you step inside, your C-Class Coupé can be fitted with polished stainless steel door sill panels featuring white-backlit 'Mercedes-Benz' lettering.

A set of striking incenio alloy wheels, meanwhile, adds even more personality to your C-Class Coupé. A wide range of styles and sizes are available.



Illuminated door sill panels with 'Mercedes-Benz' lettering

For more details about these and other C-Class Coupé accessories, please see the relevant brochure or talk to your local Mercedes-Benz Retailer.



Following the star

Test drive. A Mercedes-Benz is most at home on the road. This is the only way to experience the effortlessly superior driving feel that lends every Mercedes model its inimitable class. Feel the power of efficient engines with low fuel consumption, and precise steering designed to put you in the mood for driving. And experience what true comfort really feels like. The unique feeling of driving a Mercedes cannot be put into words, however. Which is precisely why we'd like to invite you to take a test drive. Your Mercedes-Benz Retailer will be happy to make all the necessary arrangements for you. Simply visit www.mercedes-benz.co.uk/testdrive to request a test drive. We look forward to seeing you.

Mercedes-Benz Finance. At Mercedes-Benz Finance, our single-minded aim is to provide optimum financial solutions for all those who share the Mercedes-Benz philosophy of absolute commitment to quality. Whether you are a private customer or a business user, our finance and leasing packages can be tailored to meet your individual needs. For further information on Mercedes-Benz Finance, please contact your local Mercedes-Benz Retailer.

Mercedes-Benz Insurance offers a fully comprehensive 5 star¹ Motor Insurance policy specifically designed to give you the cover you would expect from Mercedes-Benz. For a quotation, please call 0845 600 2180.²

Factory Collection. What can possibly heighten the experience of taking possession of your brand new Mercedes-Benz? The highlight might just be to see and experience where it was built in either Stuttgart, Rastatt or Bremen, and to take the long way home by driving it through some of Europe's most beautiful countryside. The Mercedes-Benz Factory Collection offers just that. Included in the Collection is an airport transfer to your hotel, one night's accommodation for one person with dinner and breakfast, a tour of the Mercedes-Benz factory, five days fully comprehensive insurance, and a return crossing by Eurotunnel (Standard Class). All you will need to pay for is your

one-way flight to Germany. For more information, please contact your local Retailer, the Mercedes-Benz Factory Collection team on 0845 273 9705 or visit www.mercedes-benz.co.uk/factorycollection

Interactive Owner's Manual. The website also offers an interactive tour, enabling you to take a closer look at your desired model. This simulation is the ideal way to acquaint yourself with your dream car. You can view key functions in detail, gain an insight into the car's inner workings or look at the benefits of each model. For further details, visit www.mercedes-benz.co.uk/cclasscoupemannual



Roadside Assistance. Rest assured that should you ever need help, Mercedes-Benz Roadside Assistance is there for you. In the unlikely event of a technical breakdown³ you can rely on the Mercedes-Benz Roadside Assistance Team – anywhere in Europe. Simply phone our Customer Assistance Centre on 00800 1 777 7777,⁴ where our specialists will organise assistance for you. Mercedes-Benz will also assist you in the event of a minor mishap preventing you from driving your vehicle.⁵ Whether you lose your key, run out of fuel or your vehicle is damaged due to an accident or vandalism, Mercedes-Benz ensures that you still reach your destination. Often the problem can be rectified on the spot, but if this is not possible, we will naturally ensure that your vehicle is taken to the nearest Mercedes-Benz Official Workshop to get you back on the road as quickly as possible.

Mercedes-Benz World at Brooklands. Celebrate the story of Mercedes-Benz and you'll celebrate the story of motoring itself at Mercedes-Benz World in Surrey. A World of experiences. A World of discoveries. A World you will love to explore. Discover Mercedes-Benz racing heritage, from its connections to the famous Brooklands circuit through to present-day Formula 1™ brought to life in the most sensational way. View, touch and sit in every car from the Mercedes-Benz range, and encounter automotive legends like the 'Gullwing' and many other classic icons, in the UK's largest Mercedes-Benz showcase. Then set your pulse racing by booking one of our thrilling Driving Experiences. Enjoy AMG performance on the purpose-built Handling Circuits or Wet Skid Circle, an axle-twisting off-road adventure, or treat your kids over 1.5 metres tall to their own driving experience in an A-Class or on the off-road terrain in an M-Class. And for kids even younger and under

1.3 metres tall, let them be a 'Little Learner' in their own miniature electric version of the desirable Mercedes-Benz SL. For more interactive action, take a virtual 3D journey along the production line in 'Build' and take a seat in the cinema to accelerate from the birth of the car to the latest innovations in 20 eye-opening minutes.

Relax and refuel in Café 1886, or for something more enjoy the delicious menu and elegant surroundings of the Gullwing Restaurant. Finally, extend your visit with a short stroll to Brooklands Museum to see their collection of classic cars, aviation exhibitions – and the legendary Concorde. For more information visit www.mercedes-benzworld.co.uk

¹ As rated by Defaqto, a leading UK independent financial research company.
Mercedes-Benz Motor Insurance is underwritten by Aviva Insurance Limited
² Calls are charged at local rate and may be recorded

³ Technical breakdown cover is initially valid for your vehicle for four years from the date of first registration. This can be extended from the fifth year, up to a maximum of 30 years, on completion of each scheduled maintenance service, providing that this service is carried out by a Mercedes-Benz Official Workshop

⁴ In non-affiliated European countries: +44 20 7975 7077

⁵ This cover can be retained from the fifth year. Your Mercedes-Benz Official Workshop will provide details of how to renew this cover once your initial four year term has expired

Dimensions

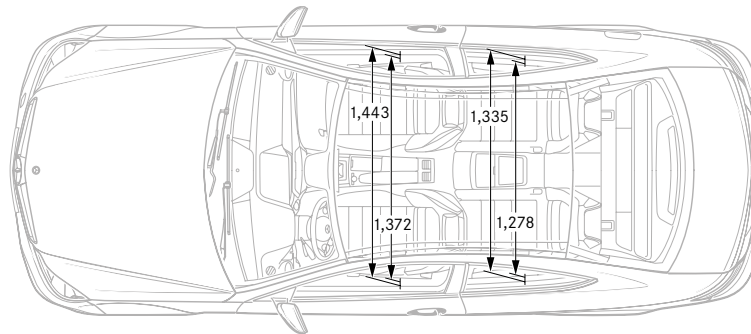
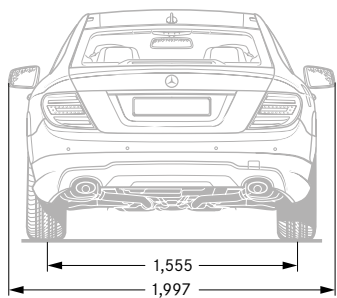
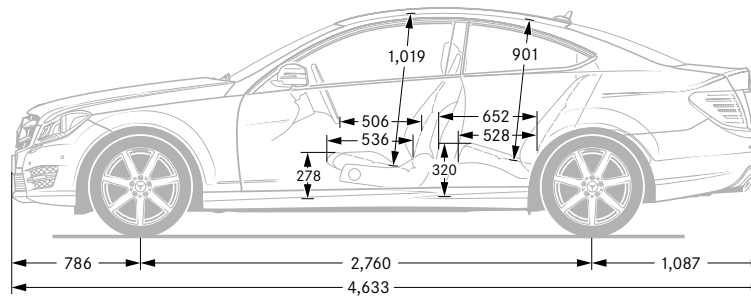
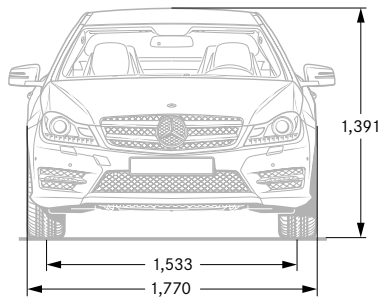

All measurements in millimetres. The dimensions shown are mean values and apply to standard-specification, unladen vehicles



Technical data

No. of cylinders/arrangement
Total displacement – cc
Rated output ¹ – hp (kW) at rpm
Rated torque ¹ – Nm at rpm
Acceleration 0–62 mph – sec (auto.)
Top speed approx. – mph (auto.)
Tyre size – front, rear
Fuel consumption ³ – mpg (auto.)
Urban
Extra-urban
Combined
CO ₂ emissions, combined ³ – g/km (auto.)
EU emissions standard
Fuel tank capacity/reserve (approx.) – l
Boot capacity – l
Turning circle – m
Kerb weight ⁴ – kg
Perm. GVW – kg

DIESEL ENGINES

C 220 CDI BlueEFFICIENCY

4/in-line

2,143

170 (125)/3,000–4,200

400/1,400–2,800

8.4 (8.1)

144 (144)

225/40 R 18, 255/35 R 18

44.8 (43.5)

65.7 (61.4)

55.4 (53.3)

133 (139)

Euro 5

66/8

450

10.84

1,615 (1,630)

2,085 (2,100)

C 250 CDI BlueEFFICIENCY

4/in-line

2,143

204 (150)/4,200

500/1,600–1,800

7.0 (7.1)

149 (149)

225/40 R 18, 255/35 R 18

41.5 (43.5)

61.4 (61.4)

52.3 (53.3)

143 (139)

Euro 5

66/8

450

10.84

1,655 (1,660)

2,125 (2,130)

¹ Figures according to Directive 80/1269/EEC in the currently applicable version ² Electronically limited ³ The figures shown were obtained in accordance with the prescribed measuring process (Directive 80/1268/EEC in the currently applicable version). The figures are not based on an individual vehicle and do not constitute part of the product offer; they are provided solely for purposes of comparison between different vehicle models



No. of cylinders/arrangement
Total displacement – cc
Rated output ¹ – hp (kW) at rpm
Rated torque ¹ – Nm at rpm
Acceleration 0–62 mph – sec (auto.)
Top speed approx. – mph (auto.)
Tyre size – front, rear
Fuel consumption ³ – mpg (auto.)
Urban
Extra-urban
Combined
CO ₂ emissions, combined ³ – g/km (auto.)
EU emissions standard
Fuel tank capacity/reserve (approx.) – l
Boot capacity – l
Turning circle – m
Kerb weight ⁴ – kg
Perm. GVW – kg

PETROL ENGINES

C 180 BlueEFFICIENCY	C 250 BlueEFFICIENCY	C 350 BlueEFFICIENCY	C 63 AMG
4/in-line	4/in-line	6/V	8/V
1,796	1,796	3,498	6,208
156 (115)/5,000	204 (150)/5,500	306 (225)/6,500	457 (336)/6,800 487 (358)/6,800 ⁵
250/1,600–4,200	310/2,300–4,300	370/3,500–5,250	600/5,000
9.0 (8.9)	– (7.2)	– (6.0)	– (4.5/4.4 ⁵)
140 (139)	– (149)	– (155) ²	– (155) ²
225/40 R 18, 255/35 R 18	225/40 R 18, 255/35 R 18	225/40 R 18, 255/35 R 18	235/40 R 18, 255/35 R 18
29.4 (31.4)	– (31.0)	– (29.4)	– (15.5)
47.9 (48.7)	– (49.6)	– (50.4)	– (33.6)
38.7 (40.4)	– (40.4)	– (40.4)	– (23.5)
169 (162)	– (163)	– (164)	– (280)
Euro 5	Euro 5	Euro 5	Euro 5
66/8	66/8	66/8	66/14
450	450	450	450
10.84	10.84	10.84	11.10
1,500 (1,520)	– (1,550)	– (1,615)	– (1,730)
1,970 (1,990)	– (2,020)	– (2,085)	– (2,160)

⁴Figures according to Directive 92/21/EC, version 95/48/EC (kerb weight with fuel tank 90% full, driver, 68 kg, and luggage, 7 kg) for standard-specification vehicles. Optional extras and accessories will generally increase this figure and reduce the payload capacity accordingly ⁵With optional AMG Performance Package Plus Values in parentheses refer to engines with automatic transmission For more specifications, visit www.mercedes-benz.co.uk

Paint finishes

The innovative Mercedes-Benz paint system features one of the finest clearcoats of any manufacturer. Its exceptionally dense molecular structure makes the paintwork more durable and lends it a deeper, more lasting sheen, helping your C-Class Coupé to retain both its looks and its long-term value.

NON-METALLIC PAINTS (standard)

- 040 Black
- 590 Fire Opal
- 650 Calcite White

METALLIC PAINTS (optional)

- 183 Magnetite Black
- 197 Obsidian Black
- 497 Cuprite Brown
- 755 Tenorite Grey
- 775 Iridium Silver
- 792 Palladium Silver
- 890 Cavansite Blue

SPECIAL METALLIC PAINT (optional)

- 799 Diamond White

designo SPECIAL PAINT (optional)

- 056 *designo* Magno Black

NON-METALLIC PAINTS



040



590



650

METALLIC PAINTS



183



197



497

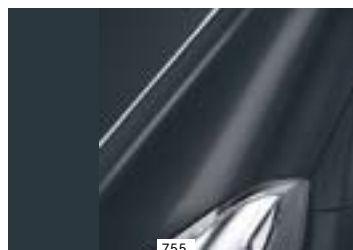

755



775



792



890

SPECIAL METALLIC PAINT



799

designo SPECIAL PAINT

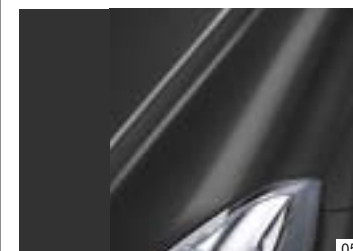

056



Take-back of end-of-life vehicles. Coming full circle. At the end of its long life, you can return your C-Class Coupé to us for environment-friendly disposal in accordance with the EC End-of-Life Vehicle Directive!¹ But that day lies a long way off.

¹Applies in accordance with national regulations to vehicles up to 3.5 tonnes gross weight. The C-Class Coupé has met the statutory regulations governing the suitability of the vehicles' design for reuse and recycling for a number of years now. A network of vehicle take-back depots and dismantlers has been established which will process your vehicle in an environment-friendly manner. The ways in which both vehicles and parts can be recovered are subject to ongoing development and improvement. Consequently, the C-Class Coupé will be able to comply with any future increases in the recycling quota within the stipulated time limits. Further information is available at www.mercedes-benz.co.uk or by calling 0808 156 6606.

Please note: this online version of the printed brochure may contain abridged copy or other content changes. The manufacturer reserves the right to make changes to the design, form, colour and specification during the delivery period, provided these changes, while taking into account the interests of the vendor, can be deemed reasonable with respect to the purchaser. Where the vendor or the manufacturer uses symbols or numbers to describe an order or the subject of an order, no rights may be derived solely from these. The illustrations may show accessories and items of optional equipment which are not part of standard specification. Colours may differ slightly from those shown. This brochure provides a general indication of the range of models, features, optional extras and/or colours available in various countries. Some of the models, features, optional extras and/or colours shown may not be available in your country or may only be available in a different specification. Additionally, some models, features, optional extras and/or colours may only be available in combination with others. For current and more specific information in relation to the range of models, features, optional extras and/or colours available in your country, and their pricing, you should contact your nearest authorised Mercedes-Benz Retailer. E&OE. www.mercedes-benz.co.uk

