



ABOVE & BEYOND

[> FIND A RETAILER](#)

[> BUILD YOUR OWN](#)

[OVERVIEW](#)

[SPECIFICATION](#)

RANGE ROVER SPORT

2016



ABOVE & BEYOND





ABOVE & BEYOND

> FIND A RETAILER

> BUILD YOUR OWN

OVERVIEW

SPECIFICATION



ABOVE & BEYOND

Ever since the first Land Rover was conceived in 1947, we have built vehicles that challenge what is possible. These in turn have challenged their owners to explore new territories and conquer difficult terrains. Our vehicles epitomize the values of the designers and engineers who have created them. Each one instilled with iconic British design cues, delivering capability with composure. Which is how we continue to break new ground, defy conventions and encourage each other to go further. Land Rover truly enables you to make more of your world, to go above and beyond.





ABOVE & BEYOND

> FIND A RETAILER

> BUILD YOUR OWN

OVERVIEW

SPECIFICATION





ABOVE & BEYOND

> FIND A RETAILER

> BUILD YOUR OWN

OVERVIEW

SPECIFICATION

IT HAS 'DRIVE ME'
WRITTEN ALL OVER IT.

Gerry McGovern
Land Rover Design Director and Chief Creative Officer

Range Rover Sport truly embodies the 'S' in SUV. Taking the marque to another level, it is the most agile, dynamic and responsive Land Rover ever. Designed and engineered to meet the needs of today, it is equally at home in the city, the back of beyond or powering down the highway.

Vehicle shown right is HSE in Mariana Black.





ABOVE & BEYOND

> FIND A RETAILER

> BUILD YOUR OWN

OVERVIEW

SPECIFICATION



CONTENTS

DESIGN		BODY AND CHASSIS	
Exterior	4	All-Aluminum Body	44
Interior	6	DRIVING ASSISTANCE	46
SVR	11	ENVIRONMENTAL	
DRIVING TECHNOLOGY		Sustainability	49
Terrain Response®	14	SPECIFICATIONS	
All-Terrain Progress Control	16	Choose Your Engine	52
Hill Descent Control	19	Choose Your Model	54
Dynamic Response	20	Choose Your Color	68
Torque Vectoring	22	Choose Your Wheels	70
Adaptive Dynamics	23	Choose Your Interior	72
Dynamic Stability Control	23	Choose Your Accessories	82
Electronic Suspension	24	TECHNICAL DETAILS	92
Automatic Access Height	24	LAND ROVER EXPERIENCE	94
Dynamic Response (SVR)	26		
Towing and Driving Aids	28		
FINISHING TOUCHES			
Meridian™ Sound System	30		
Driver Aids	32		
Comfort For All	35		
Land Rover InControl™	38		
POWERTRAINS			
Eight-Speed Automatic Transmission	41		
Diesel and Gasoline Engines	42		



ABOVE & BEYOND

> FIND A RETAILER

> BUILD YOUR OWN

OVERVIEW

SPECIFICATION

DESIGN

EXTERIOR

Born from a relentless drive to create a contemporary yet authentic design, its distinctive silhouette, streamlined front elevation and rearward sloping roof give the vehicle immense road presence.

With seductive flowing lines and stylish features such as the side vent and grille, the sophisticated design of the vehicle is conveyed without compromising its character.

It is beautifully proportioned with a muscular and contemporary look. The tapered bodywork and wide track help give the vehicle a powerful, planted stance.

While the gentle curves, signature headlamps and sculpted corners denote the precision of its design that is unmistakably Land Rover.



4 Vehicle shown left and right is HSE in Mariana Black.



DESIGN

DRIVING TECHNOLOGY

FINISHING TOUCHES

POWERTRAINS

BODY AND CHASSIS

DRIVING ASSISTANCE

ENVIRONMENTAL





ABOVE & BEYOND

> FIND A RETAILER

> BUILD YOUR OWN

OVERVIEW

SPECIFICATION



DESIGN

DRIVING TECHNOLOGY

FINISHING TOUCHES

POWERTRAINS

BODY AND CHASSIS

DRIVING ASSISTANCE

ENVIRONMENTAL





ABOVE & BEYOND

> FIND A RETAILER

> BUILD YOUR OWN

OVERVIEW

SPECIFICATION

INTERIOR

Contemporary. Beautifully designed. Flawlessly executed.

The Range Rover Sport interior is meticulously appointed to reflect its character. Superb detailing, strong elegant lines and clean surfaces combined with luxurious soft touch finishes. Intuitively placed controls, such as the **CommandShift® 2**, create a cabin that places the driver at its center.

The centerpiece of the interior is the bold intersection between the strong horizontal elements of the instrument panel and the vertical lines of the center console. The dynamic character of the cockpit is complemented by the sharper angle of the center console, with its striking satin metal pillars which flow from the instrument panel through into the rear cabin.

Interior shown is HSE in Ebony / Ivory with Ivory seats with Grand Black Wood Veneer.





ABOVE & BEYOND

> FIND A RETAILER

> BUILD YOUR OWN

OVERVIEW

SPECIFICATION



DESIGN

DRIVING TECHNOLOGY

FINISHING TOUCHES

POWERTRAINS

BODY AND CHASSIS

DRIVING ASSISTANCE

ENVIRONMENTAL





ABOVE & BEYOND

> FIND A RETAILER

> BUILD YOUR OWN

OVERVIEW

SPECIFICATION





ABOVE & BEYOND

> FIND A RETAILER

> BUILD YOUR OWN

OVERVIEW

SPECIFICATION

The finest materials and a keen eye for detail helped to shape this comfortable yet purposeful space. The strong architectural lines of the interior are balanced by soft lighting and the choice of color themes available. The use of leather and metal truly complements the sporty styling.

5+2 SEATING

For additional seating versatility, the optional 5+2 arrangement* has two seats stowed under the floor of the luggage compartment and are split 50/50.

They have been designed for occasional use, enabling the vehicle to accommodate up to seven occupants.

The second row seats have forwards / backwards movement of 3.94 inches allowing for better access to the third row seats and flexible accommodation.

Power operation is standard for the third row seats. When folded, the third row seats leave a flat floor in the luggage compartment with no loss of space.



*The third row seats are suitable for use by older children who can either use the adult belt or a booster seat in conjunction with the adult belt. They are not suitable for smaller children who require a child seat where the adult belt is not used directly to restrain the child.

Interior shown is HSE in Ebony / Ivory with Ivory seats with Grand Black Wood Veneer.

DESIGN

9

DESIGN

DRIVING TECHNOLOGY

FINISHING TOUCHES

POWERTRAINS

BODY AND CHASSIS

DRIVING ASSISTANCE

ENVIRONMENTAL



ABOVE & BEYOND

> FIND A RETAILER

> BUILD YOUR OWN

OVERVIEW

SPECIFICATION





ABOVE & BEYOND

> FIND A RETAILER

> BUILD YOUR OWN

OVERVIEW

SPECIFICATION



RANGE ROVER SPORT SVR IS A NATURAL PROGRESSION BEYOND THE CORE VEHICLE'S OUTSTANDING ON AND OFF-ROAD CAPABILITIES AND LEADING-EDGE DESIGN. IT IS TRULY THE WORLD'S MOST CAPABLE PERFORMANCE SUV.

John Edwards

Managing Director of Special Vehicle Operations

SVR

EXTERIOR

Designed and engineered by Special Vehicle Operations (SVO) – the Land Rover center of excellence for bespoke commissions, luxury editions and performance models – Range Rover Sport SVR builds on the marque's capabilities and creates a performance SUV that is even more exhilarating.

This is immediately apparent in the SVR design, with the vehicle's muscular, broad shouldered stance being the perfect complement to its performance and handling. Large air intakes in the front bumper promote great airflow to the two charge air coolers while the rear spoiler increases downforce at high speeds.



Vehicle shown left is SVR in Estoril Blue with Santorini Contrast Roof.

DESIGN

11

DESIGN

DRIVING TECHNOLOGY

FINISHING TOUCHES

POWERTRAINS

BODY AND CHASSIS

DRIVING ASSISTANCE

ENVIRONMENTAL



ABOVE & BEYOND

> FIND A RETAILER

> BUILD YOUR OWN

OVERVIEW

SPECIFICATION



INTERIOR FEATURES

The stylish cabin has been ergonomically designed around the driver. The 14-way Sports Powered seats – with memory and SVR embossing on the seat back – are in the softest Oxford Perforated leather.

A choice of four color themes enables you to personalize the space to your taste. Deft touches such as optional Carbon Fiber trim add greatly to the look.

Range Rover Sport SVR. Sit behind the wheel and you will know why it takes the performance SUV to its most rounded, electrifying and compelling level yet.

Interior shown above and right is SVR in Ebony / Cirrus.





ABOVE & BEYOND

> FIND A RETAILER

> BUILD YOUR OWN

OVERVIEW

SPECIFICATION



DESIGN

DRIVING TECHNOLOGY

FINISHING TOUCHES

POWERTRAINS

BODY AND CHASSIS

DRIVING ASSISTANCE

ENVIRONMENTAL





ABOVE & BEYOND

> FIND A RETAILER

> BUILD YOUR OWN

OVERVIEW

SPECIFICATION

DRIVING TECHNOLOGY

TERRAIN RESPONSE

With over 65 years of all-terrain expertise, this vehicle has Land Rover capability at its heart. Our unique **Terrain Response®** system* enables the driver to optimize the vehicle's engine, transmission, center differential and chassis systems to match the demands of the terrain, by selecting one of the easily identifiable driving modes.

The optional **Terrain Response® 2** system* enhances this further by monitoring driving conditions and automatically selecting the driving modes to achieve the best possible chassis and powertrain set up for the conditions.

There are up to six Terrain Response® modes: General Driving, Grass/Gravel/Snow, Mud and Ruts, Sand, Rock Crawl and Dynamic.

The optional **Terrain Response® Dynamic** setting* allows the driver to select a dedicated program for enthusiastic on-road driving, delivering a much more engaging and agile driving experience, with a firmer ride, tighter body control with reduced roll, and more responsive steering and performance.



*These systems are not a substitute for driving safely with due care and attention and will not function under all circumstances, speeds, weather and road conditions, etc. Driver should not assume that these systems will correct errors of judgment in driving. Please consult the owner's manual or your local authorized Land Rover Retailer for more details.



ABOVE & BEYOND

> FIND A RETAILER

> BUILD YOUR OWN

OVERVIEW

SPECIFICATION



DRIVING TECHNOLOGY

15

DESIGN

DRIVING TECHNOLOGY

FINISHING TOUCHES

POWERTRAINS

BODY AND CHASSIS

DRIVING ASSISTANCE

ENVIRONMENTAL





ABOVE & BEYOND

> FIND A RETAILER

> BUILD YOUR OWN

OVERVIEW

SPECIFICATION

ALL-TERRAIN PROGRESS CONTROL

All-Terrain Progress Control is a technologically advanced system that is designed to enable drivers to set and maintain a steady speed in challenging conditions*.

Operating like a cruise control system, it functions as an off road crawl mode between 1mph and 18mph, enabling the driver to maintain full concentration on steering and finding a path through obstacles, while the vehicle controls the engine and brakes to hold a comfortable, steady speed.

Developed by the all-terrain specialists at Land Rover, the system requires no additional hardware or sensors, and works seamlessly alongside the Terrain Response® 2, traction and braking systems.

Once All-Terrain Progress Control is activated, the standard steering wheel +/- cruise control buttons are used to set the speed; brake and accelerator pedals can still override the chosen settings, with gentle braking achieving a reduction in target speed.



*These systems are not a substitute for driving safely with due care and attention and will not function under all circumstances, speeds, weather and road conditions, etc. Driver should not assume that these systems will correct errors of judgment in driving. Please consult the owner's manual or your local authorized Land Rover Retailer for more details.
Vehicle shown above and right is Autobiography in Corris Grey.



ABOVE & BEYOND

> FIND A RETAILER

> BUILD YOUR OWN

OVERVIEW

SPECIFICATION



< DESIGN

DRIVING TECHNOLOGY

FINISHING TOUCHES

POWERTRAINS

BODY AND CHASSIS

DRIVING ASSISTANCE

ENVIRONMENTAL >



ABOVE & BEYOND

> FIND A RETAILER

> BUILD YOUR OWN

OVERVIEW

SPECIFICATION



DESIGN

DRIVING TECHNOLOGY

FINISHING TOUCHES

POWERTRAINS

BODY AND CHASSIS

DRIVING ASSISTANCE

ENVIRONMENTAL





ABOVE & BEYOND

> FIND A RETAILER

> BUILD YOUR OWN

OVERVIEW

SPECIFICATION



HILL DESCENT CONTROL (HDC®)

To complement the Terrain Response® system, Range Rover Sport can also call upon a unique suite of all-terrain technologies to help maximize performance.

Hill Descent Control (HDC®)* assists with controlled descent of difficult slopes by maintaining a constant speed and applying braking separately to each wheel. **Hill Start Assist** ensures you do not roll backwards as you pull away on an incline.

The vehicle also utilizes **Gradient Release Control*** which is designed to prevent the vehicle 'running away' on a steep incline when the driver inadvertently releases the brake.

Vehicle shown left is Autobiography in Corris Grey.

*These systems are not a substitute for driving safely with due care and attention and will not function under all circumstances, speeds, weather and road conditions, etc. Driver should not assume that these systems will correct errors of judgment in driving. Please consult the owner's manual or your local authorized Land Rover Retailer for more details.





ABOVE & BEYOND

> FIND A RETAILER

> BUILD YOUR OWN

OVERVIEW

SPECIFICATION

DYNAMIC RESPONSE

Dynamic Response* transforms vehicle handling through hydraulic body lean control, optimizing on road performance and passenger comfort, by reducing the amount of body lean during cornering or uneven road surfaces.

Our latest two-channel system is capable of controlling the front and rear axles independently, allowing it to be tuned to deliver increased low-speed agility, along with enhanced control and stability at speed.

With this feature, off-road capability is improved. If the system detects off-road conditions, the control module reduces the level of roll compensation, thus allowing greater wheel articulation and increasing the contact patch with the terrain.

When operating in Dynamic Response mode, wheel articulation is an impressive 21.5 inches*.

Roll Stability Control** is a sophisticated roll-over mitigation system that uses gyroscopic sensing to detect the onset of a potential roll-over; brakes are applied on the outer wheels to widen the turn radius and reduce the likelihood of a roll-over.

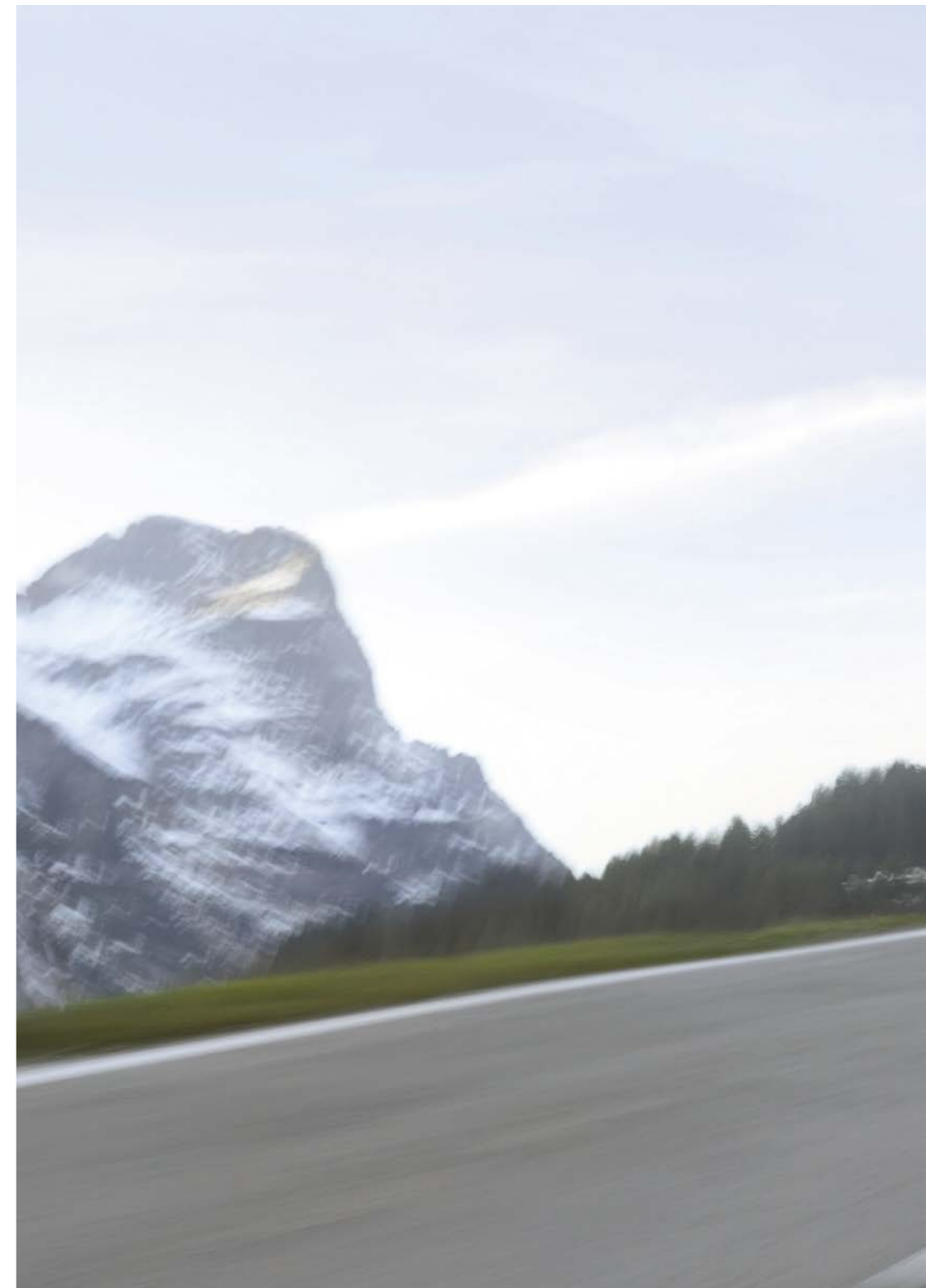

Vehicle shown right is HSE in Mariana Black.

* 20.4 inches on SVR model.

**These systems are not a substitute for driving safely with due care and attention and will not function under all circumstances, speeds, weather and road conditions, etc. Driver should not assume that these systems will correct errors of judgment in driving. Please consult the owner's manual or your local authorized Land Rover Retailer for more details.



ABOVE & BEYOND

> FIND A RETAILER

> BUILD YOUR OWN

OVERVIEW

SPECIFICATION



DRIVING TECHNOLOGY

21

DESIGN

DRIVING TECHNOLOGY

FINISHING TOUCHES

POWERTRAINS

BODY AND CHASSIS

DRIVING ASSISTANCE

ENVIRONMENTAL





ABOVE & BEYOND

> FIND A RETAILER

> BUILD YOUR OWN

OVERVIEW

SPECIFICATION

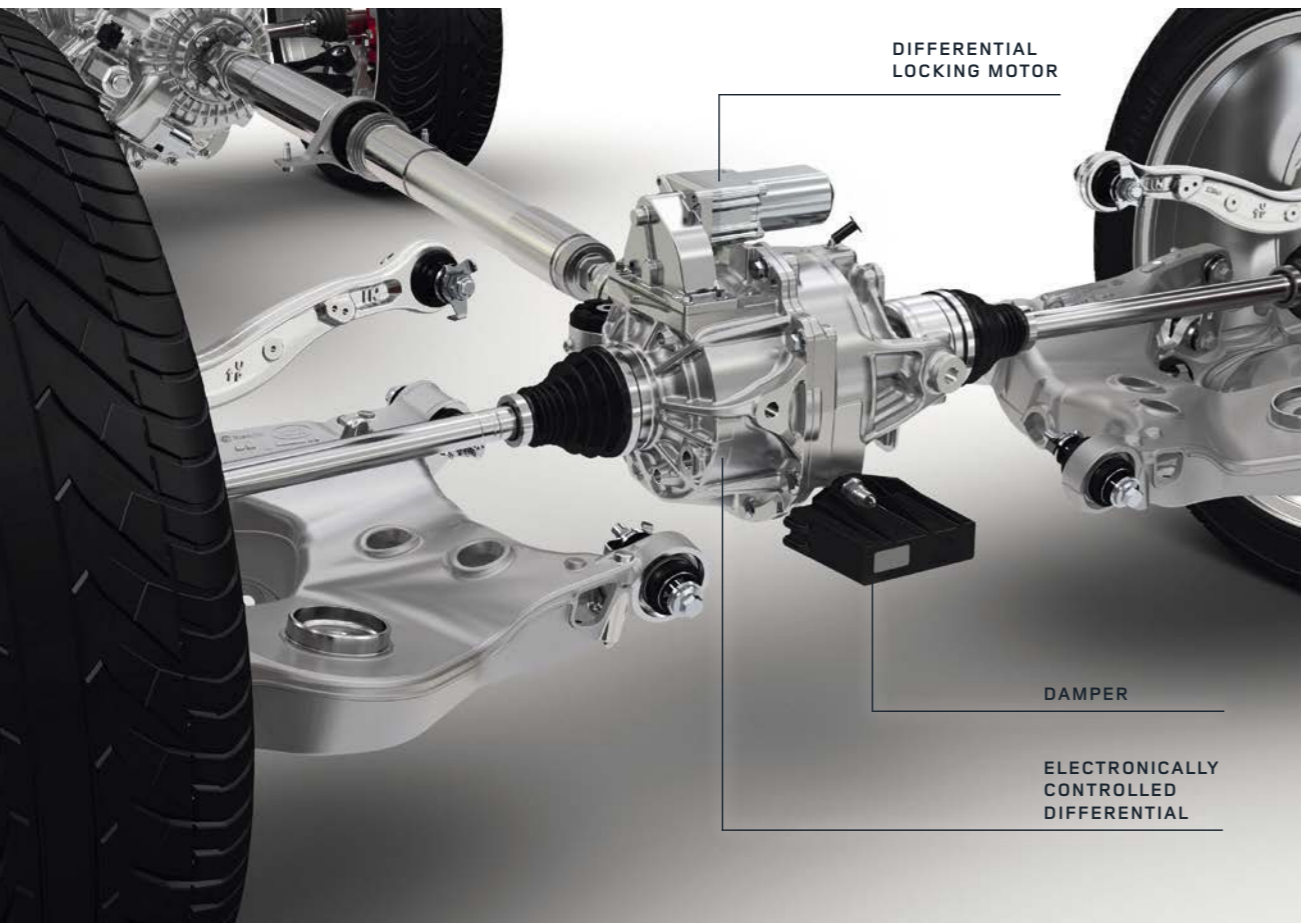

TORQUE VECTORING

The Torque Vectoring system* with Dynamic Active Rear Locking Differential delivers responsive, controlled cornering and handling through even the tightest of bends. The electronic differential and vehicle's brake system constantly balance the distribution of engine torque between the four wheels when cornering.

Exceptional grip and steering confirm Range Rover Sport as our most dynamic SUV.

The system is also active in off-road conditions using the relevant Terrain Response settings. It can be very effective in conditions such as sand, where it helps the vehicle turn in and avoid excessive understeer.

Vehicle shown above is HSE in Mariana Black.



ABOVE & BEYOND

> FIND A RETAILER

> BUILD YOUR OWN

OVERVIEW

SPECIFICATION

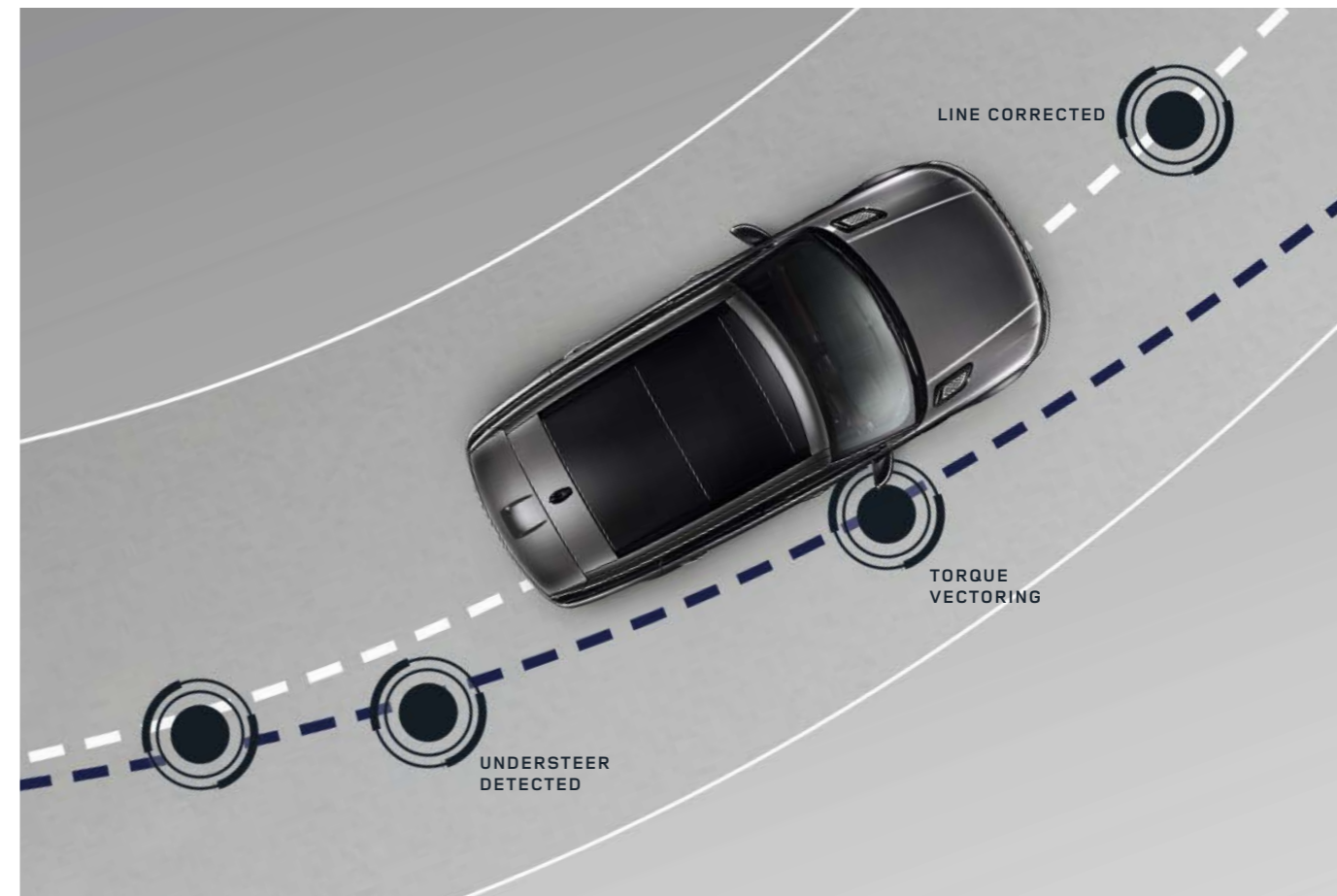

ADAPTIVE DYNAMICS

Featuring continuously variable suspension dampers Adaptive Dynamics* provides the optimum balance of ride and control by offering infinitely variable damper settings between soft and firm extremes.

The system monitors vehicle movements at least 500 times per second, reacting to driver or road inputs virtually instantaneously to give great control and minimize body lean, providing a composed, flat ride. The system even senses off-road conditions, and optimizes damping accordingly.

DYNAMIC STABILITY CONTROL

Gain more control when cornering as Dynamic Stability Control* is designed to detect deviation from your chosen course and to apply appropriate braking.

The system monitors the vehicle 100 times per second via the Dynamic Stability Control module. As the vehicle accelerates through a corner, the system uses yaw sensors to detect the beginning of understeer.

Imperceptible levels of braking are then used to correct the vehicle attitude, while engine torque is transferred to the outside wheels, which have more grip, thus helping to maintain traction and steering control.

*These systems are not a substitute for driving safely with due care and attention and will not function under all circumstances, speeds, weather and road conditions, etc. Driver should not assume that these systems will correct errors of judgment in driving. Please consult the owner's manual or your local authorized Land Rover Retailer for more details.



ABOVE & BEYOND

> FIND A RETAILER

> BUILD YOUR OWN

OVERVIEW

SPECIFICATION



ELECTRONIC SUSPENSION

Range Rover Sport features a **Four-Corner Air Suspension system** which delivers exceptional comfort and capabilities both on and off-road.

The air suspension system automatically switches between two ride heights when the off-road setting is selected. Maximum ground clearance is increased by 2.6 inches above normal ride height at speeds less than 30mph.

The suspension system delivers impressive wheel travel – with 10.2 inches of movement at the front and 10.7 inches at the rear, providing exceptional wheel articulation and composure to deal with the toughest conditions.

AUTOMATIC ACCESS HEIGHT

Attention to detail is everywhere you look and in everything you touch. For instance, the new Automatic Access Height feature lowers the vehicle with precision by up to two inches, for easier entry and exit when parked. Arriving in style at any function has never been more relaxed.

The Touch-screen for the 2016 Range Rover may differ from the one shown above. Vehicle shown right is HSE in Mariana Black.

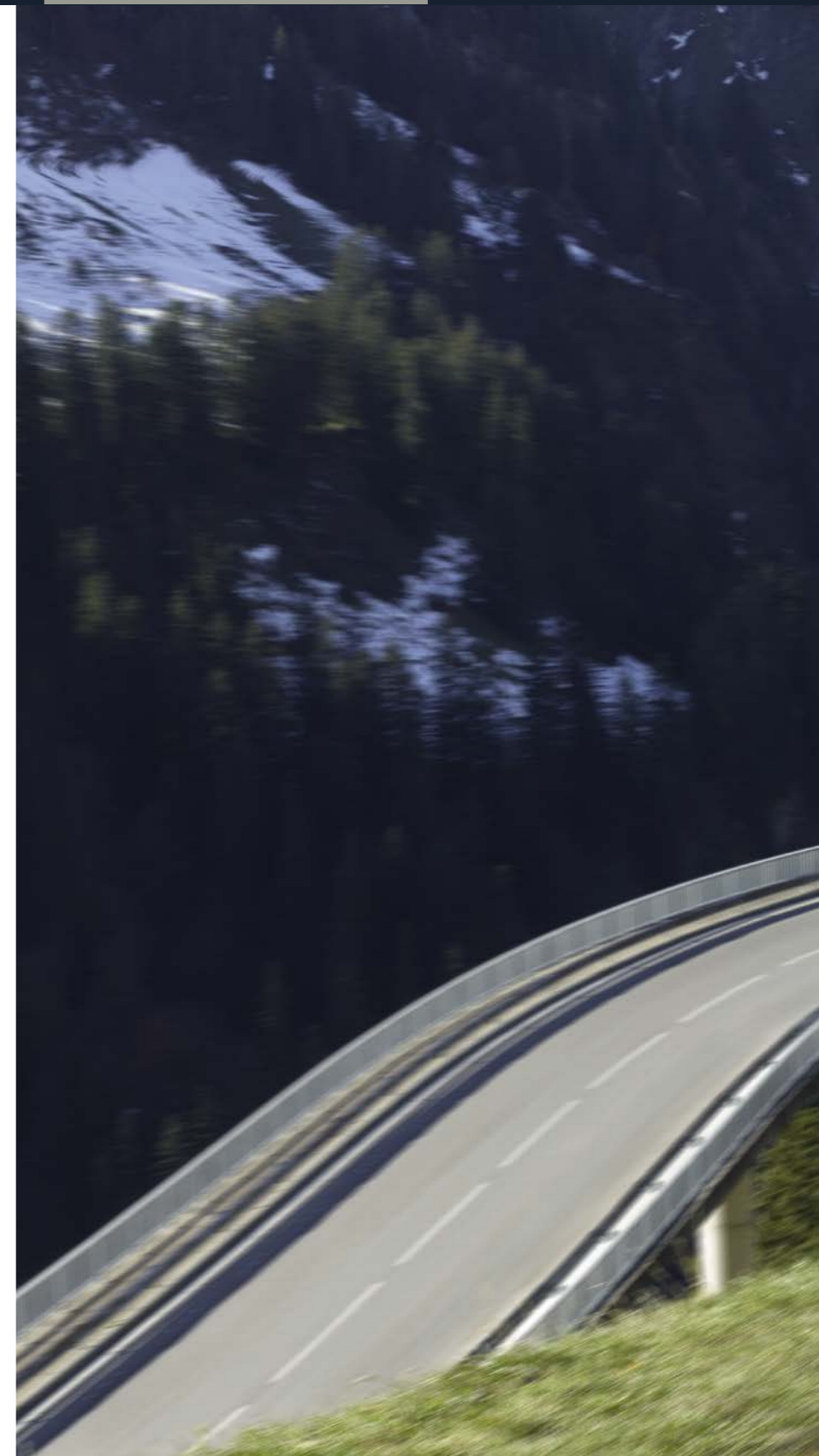



ABOVE & BEYOND

> FIND A RETAILER

> BUILD YOUR OWN

OVERVIEW

SPECIFICATION



DESIGN

DRIVING TECHNOLOGY

FINISHING TOUCHES

POWERTRAINS

BODY AND CHASSIS

DRIVING ASSISTANCE

ENVIRONMENTAL





ABOVE & BEYOND

> FIND A RETAILER

> BUILD YOUR OWN

OVERVIEW

SPECIFICATION

SVR DYNAMIC RESPONSE

Working with the vehicle's upgraded air springs and **Adaptive Dynamics** continuously variable suspension dampers, the two-channel Dynamic Response* system is specially tuned to enhance the high-performance capability of the Range Rover Sport SVR.

Indeed, the SVR is so competent on asphalt that Land Rover engineers had to completely re-scale existing Dynamic Response graphs to take account of its cornering ability, allowing the Range Rover Sport SVR to corner flatter and faster than any other Land Rover in history.

The system is also tuned to deliver a progressive breakaway at the limit. This ensures the vehicle remains easy to control at the tires' limits.

While Dynamic Response is tuned to behave uniquely for the Range Rover Sport SVR during performance driving, it automatically reverts to the same software map as other Range Rover Sport models once off-road use is detected by sensors monitoring body movement, wheel positions and vehicle height. This greatly reduces body lean at speeds up to 25mph and maintains excellent off-road capability.

Vehicle shown below and right is SVR in Estoril Blue with Santorini Contrast Roof.

*These systems are not a substitute for driving safely with due care and attention and will not function under all circumstances, speeds, weather and road conditions, etc. Driver should not assume that these systems will correct errors of judgment in driving. Please consult the owner's manual or your local authorized Land Rover Retailer for more details.





ABOVE & BEYOND

> FIND A RETAILER

> BUILD YOUR OWN

OVERVIEW

SPECIFICATION



DRIVING TECHNOLOGY

27

DESIGN

DRIVING TECHNOLOGY

FINISHING TOUCHES

POWERTRAINS

BODY AND CHASSIS

DRIVING ASSISTANCE

ENVIRONMENTAL





ABOVE & BEYOND

> FIND A RETAILER

> BUILD YOUR OWN

OVERVIEW

SPECIFICATION



TOWING AND DRIVING AIDS

With a towing capacity of up to 7,716 lbs* and by incorporating tailored technologies, Range Rover Sport can handle the most demanding of tasks.

TOW HITCH ASSIST

Tow Hitch Assist makes coupling a trailer to the vehicle much easier by helping you visualize the hitching process; it displays the predicted path of the vehicle towards the trailer tow bar on the Touch-screen**.

On the road, the Tow Assist feature helps with reversing by predicting the trailer's direction. You can even choose your trailer's width for precise guidelines displayed on the Touch-screen.

SURROUND CAMERA SYSTEM

For a complete, all-round view, the optional Surround Camera System incorporating **T-Intersection View** helps to see everything clearly on the high-resolution full-color Touch-screen**. Using four digital cameras discreetly placed around the vehicle, the system provides an almost complete 360 degree view including a birds-eye overhead view. It aids parking and is perfect for more complex driving assignments such as towing a boat or horse trailer by displaying the predicted path of the trailer on the Touch-screen.

Along with the ability to display several different views at the same time, this technology can also zoom and pan, ensuring objects and angles, normally below the line of sight, can be seen.



*6,614 lbs limit on SVR model **These systems are not a substitute for driving safely with due care and attention and will not function under all circumstances, speeds, weather and road conditions, etc. Driver should not assume that these systems will correct errors of judgment in driving. Please consult the owner's manual or your local authorized Land Rover Retailer for more details.

The Touch-screen for the 2016 Range Rover may differ from the one shown above. Vehicle shown right is an accessorized Autobiography in Corris Grey. Accessories shown include Noble Plated Mirror Caps, Stainless Steel Front Undershield, Side Protection Tubes and 21 inch forged nine-spoke 'Style 705' with Satin Black finish.



ABOVE & BEYOND

> FIND A RETAILER

> BUILD YOUR OWN

OVERVIEW

SPECIFICATION



DRIVING TECHNOLOGY

29

DESIGN

DRIVING TECHNOLOGY

FINISHING TOUCHES

POWERTRAINS

BODY AND CHASSIS

DRIVING ASSISTANCE

ENVIRONMENTAL





ABOVE & BEYOND

> FIND A RETAILER

> BUILD YOUR OWN

OVERVIEW

SPECIFICATION



FINISHING TOUCHES

MERIDIAN™ SOUND SYSTEM

Meridian products offer the very best in British engineering, technology and design. Just like Land Rover. It is an intuitive and personal experience. Meridian sound masters have employed years of psychoacoustic research to enable you to experience music in a new dimension.

MERIDIAN SIGNATURE REFERENCE SYSTEM (1700W)

The optional 1700 Watt system has 23 speakers and 22 channels, including a dual channel subwoofer, with four speakers located in the roof lining delivering a true to life musical performance. While all our sound systems offer highly optimized sound quality, the 1700 Watt system incorporates Meridian Trifield* 3D technology, which provides greater control over the content of the surround and side channels, as well as additional signal feeds for height speakers.

This innovative technology expands the sense of space within the cabin, providing a personal, realistic three-dimensional listening experience in every seat. Your entertainment system comes with **Conversation Assist**, a feature that aids normal conversation between everyone in the vehicle, by a microphone that is linked from the rear seats to speakers in the front.

MERIDIAN SURROUND SOUND SYSTEM (825W)

The 825 Watt system has 19 speakers and 16 channels, including a dual channel subwoofer, that are placed in ideal positions around the vehicle. This optional system also incorporates Meridian Trifield* technology to create a concert-like experience for all occupants.

*Trifield and the "three fields" device is a trademark of Trifield Productions Ltd.

DESIGN

DRIVING TECHNOLOGY

FINISHING TOUCHES

POWERTRAINS

BODY AND CHASSIS

DRIVING ASSISTANCE

ENVIRONMENTAL



ABOVE & BEYOND

> FIND A RETAILER

> BUILD YOUR OWN

OVERVIEW

SPECIFICATION



MERIDIAN SIGNATURE REFERENCE SYSTEM

1700 WATTS

23 SPEAKERS

SUBWOOFER

FINISHING TOUCHES

31

DESIGN

DRIVING TECHNOLOGY

FINISHING TOUCHES

POWERTRAINS

BODY AND CHASSIS

DRIVING ASSISTANCE

ENVIRONMENTAL



ABOVE & BEYOND

> FIND A RETAILER

> BUILD YOUR OWN

OVERVIEW

SPECIFICATION

DRIVER AIDS



SPORTS COMMAND DRIVING POSITION

Range Rover Sport provides drivers with a Sports Command Driving Position* by elevating the driver within the vehicle, delivering the supreme sense of confidence and control with a sporting, less upright seating position.

This offers a reassuring view of the vehicle and its surroundings, with clear visibility to the side and outstanding forward visibility over the characteristic profile of the hood; all of which contribute to the unique Range Rover Sport character.

Vehicle shown above is HSE in Mariana Black.

*These systems are not a substitute for driving safely with due care and attention and will not function under all circumstances, speeds, weather and road conditions, etc. Driver should not assume that these systems will correct errors of judgment in driving. Please consult the owner's manual or your local authorized Land Rover Retailer for more details.

ELECTRIC POWER ASSISTED STEERING (EPAS)

The Electric Power Assisted Steering (EPAS) system helps to deliver accurate, consistent steering and agile cornering*. Power assistance is speed-sensitive so the steering is light and responsive at lower speeds and firmer at higher speeds. It is also energy efficient and reduces fuel consumption.



ABOVE & BEYOND

> FIND A RETAILER

> BUILD YOUR OWN

OVERVIEW

SPECIFICATION



FULL THIN FILM TRANSISTOR (TFT) INSTRUMENT PANEL

The available 12.3 inch virtual instrument panel uses high-resolution display technology and color graphics for clear communication of the main vehicle functions and data. With elegant virtual dials it can be tailored to display only information that is relevant to the current driving situation.

HEAD UP DISPLAY

Head Up Display* is an option that presents key vehicle data such as road speed, gear selection and navigation directions on the windshield, without distraction or the need for you to take your eyes off the road.

The Land Rover system features laser holographic techniques, resulting in superior color saturation, brightness and contrast.

The innovative laser system is more robust against issues such as 'washout' – the effect that the glare from sunlight has on LED-based systems. The system is fully configurable and can be customized to your specific tastes.



ABOVE & BEYOND

> FIND A RETAILER

> BUILD YOUR OWN

OVERVIEW

SPECIFICATION





ABOVE & BEYOND

> FIND A RETAILER

> BUILD YOUR OWN

OVERVIEW

SPECIFICATION

COMFORT FOR ALL



CLIMATE CONTROL

To ensure that the interior is maintained at the perfect temperature whatever the weather outside, Range Rover Sport features a climate control system which is based on the latest technology. The result of an incredibly rigorous development program, the system has been tested in real-world conditions in temperatures ranging from +122 to -22°F.

Three versions are available: the standard two-zone system, a three-zone system, or the premium four-zone system with separate climate controls for driver, front passenger and each side of the rear cabin.

With its independent heating and cooling capability in the rear compartment, the four-zone system offers great comfort in the rear seats, with multiple outlets at face, foot and hip level.

CONFIGURABLE INTERIOR MOOD LIGHTING

Passengers can change the interior lighting to suit their tastes. There are ten colors in total ranging from Spark Blue through to Ice White and Racing Red. Simply operated variable brightness controls can help create the desired mood. The clean, elegant lines and premium materials of the interior are complemented by carefully detailed LED mood lighting that brings the cabin alive at night.

PANORAMIC ROOF

For a luxurious traveling experience, the available full-size sliding panoramic roof*, allows light to pour into the cabin, making it feel spacious and relaxed. It is designed to maintain a comfortable interior temperature with solar protection built into the glass.

For additional shade, a sun blind with a solar reflective coating can be extended across the full surface of the glass roof. A fixed panoramic roof is also available**.

*Not available on SE and optional on HSE **Optional on SE, standard on HSE and available as a no cost option on SVR. The Touch-screen for the 2016 Range Rover may differ from the one shown above. Interior shown left is HSE in Ebony / Ivory with Ivory seats.



ABOVE & BEYOND

> FIND A RETAILER

> BUILD YOUR OWN

OVERVIEW

SPECIFICATION



DESIGN

DRIVING TECHNOLOGY

FINISHING TOUCHES

POWERTRAINS

BODY AND CHASSIS

DRIVING ASSISTANCE

ENVIRONMENTAL



ABOVE & BEYOND

> FIND A RETAILER

> BUILD YOUR OWN

OVERVIEW

SPECIFICATION

COMFORT FOR ALL

REAR SEAT ENTERTAINMENT

The optional Rear Seat Entertainment System provides eight-inch screens built into the front headrests. This system comes with with a pair of WhiteFire™ digital wireless headphones and a USB connector.

GESTURE TAILGATE

This feature adds practicality and makes life with your Range Rover Sport even easier. Electronically operated, simply by performing a smooth upward movement of the foot beneath the rear corner of the vehicle, Gesture Tailgate enables the driver to operate the tailgate (both to open and close) from the curbside without needing to physically touch either the vehicle or the key fob. And as the system is compatible with accessory towing solutions, you can still tackle demanding situations with the least amount of fuss.

SOFT DOOR CLOSE

For additional convenience, the Range Rover Sport is available with power latching on all doors. This allows the last quarter inch of the doors motion to be controlled and provides a soft close.



WhiteFire™ is a trademark of Unwired Technology LLC and any use of such marks by Land Rover is under license.
Interior shown left is HSE in Espresso / Ivory with Ivory seats.
Vehicle shown right is HSE in Mariana Black.

FINISHING TOUCHES

37

DESIGN

DRIVING TECHNOLOGY

FINISHING TOUCHES

POWERTRAINS

BODY AND CHASSIS

DRIVING ASSISTANCE

ENVIRONMENTAL



ABOVE & BEYOND

> FIND A RETAILER

> BUILD YOUR OWN

OVERVIEW

SPECIFICATION

LAND ROVER INCONTROL®



TOUCH-SCREEN

The Touch-screen* is the command center for a wealth of features designed to make your driving experience more entertaining. It features a contemporary and fresh graphical design displayed on an eight-inch screen*.

It is the central hub from where you can connect and control your chosen entertainment and media. You can therefore enjoy an unimaginable amount of music all within one simple to use system. The ability to connect your smartphone via Bluetooth® is also available.

It is the interface where you can control the ambient lighting to suit your mood and preference, by varying the color and brightness level. The system also controls the air flow distribution within the vehicle.

The Touch-screen provides all of the capabilities that you need such as navigation system, Bluetooth® connection on your phone, ECO Data functionality and the Land Rover 4x4i function*.





ABOVE & BEYOND

LAND ROVER INCONTROL®

INCONTROL PROTECT™

InControl Protect™ enables you to monitor your vehicle wherever you are.

InControl Protect gives you peace of mind through SOS Emergency call and Optimized Land Rover Assistance. In the event of an emergency, the SOS Emergency call notifies the emergency services of the location of your vehicle.

INCONTROL REMOTE™

InControl Remote™ is an app available on Android™ and iPhone®, which allows you to interact with your vehicle remotely. InControl Remote not only provides basic information with the use of a remote it also enables you to communicate with your vehicle. You are able to lock/unlock your vehicle and set a 'beep and flash' in order to locate your vehicle in a crowded parking lot.**

The InControl Remote App ensures you are fully prepared for your journey by displaying the fuel level and location of your vehicle. The Remote App also gives you vital information on fluid levels and whether your vehicle is locked or any doors or windows are open. You are also able to download your journeys to assist in reviewing mileage.

INCONTROL® APPS™*

Connects your smartphone with the Touch-screen in your vehicle, meaning you can stay connected to your smartphone. Land Rover InControl® Apps™ enables you to control compatible apps on the InControl Touch-screen, ensuring the convenient use of apps that have been optimized specifically for use within your vehicle.

INCONTROL WI-FI™

Creates a Wi-Fi hotspot, allowing you and your passengers to stay connected on the move. You can connect up to eight devices to browse and stream the web, meaning you never have to be out of touch.

*Do not use Land Rover InControl® features under conditions that will affect your safety or the safety of others. Driving while distracted can result in loss of vehicle control.

**Functionality is market dependent. Please ask your Land Rover Retailer for more information.

iPhone® is a registered trademark of Apple Inc., registered in the US and other countries.

Features and their availability may differ by vehicle specification and market. Please contact your Land Rover Retailer for further information.

The Bluetooth® word mark and logos are owned by the Bluetooth SIG, Inc. and any use of such marks by Land Rover is under license.



ABOVE & BEYOND

> FIND A RETAILER

> BUILD YOUR OWN

OVERVIEW

SPECIFICATION





ABOVE & BEYOND

> FIND A RETAILER

> BUILD YOUR OWN

OVERVIEW

SPECIFICATION



POWERTRAINS

EIGHT-SPEED AUTOMATIC TRANSMISSION

All engines in the Range Rover Sport are paired with the advanced electronically controlled ZF® eight-speed automatic transmission which offers silky-smooth shifting with rapid response.

With eight closely spaced ratios, gear changes are almost imperceptible, with each shift completed in just 200 milliseconds – four times faster than the average human resting heartbeat.

Controls include available steering wheel mounted paddle shifters, enabling the driver to take control of gear shifting manually. The transmission accepts multiple downshifts, maintaining an absolutely smooth transition between ratios.

The optimized lightweight eight-speed transmission is the perfect partner to the torque-rich gasoline and diesel engines, and contributes to their enhanced fuel efficiency.

The transmission is tuned to select torque converter lock-up as early as possible to reduce slip and energy loss. **Transmission Idle Control** disengages 70 percent of the drive when the vehicle is stationary and the engine is idling in Drive, significantly reducing consumption in urban conditions.

In cold conditions, the transmission selects a lower gear to promote fast warm up and get the engine up to its efficient operating temperature as soon as possible.

Vehicle shown left is HSE in Corris Grey.

ENGINES

41

DESIGN

DRIVING TECHNOLOGY

FINISHING TOUCHES

POWERTRAINS

BODY AND CHASSIS

DRIVING ASSISTANCE

ENVIRONMENTAL



ABOVE & BEYOND

> FIND A RETAILER

> BUILD YOUR OWN

OVERVIEW

SPECIFICATION

DIESEL ENGINE

254 HP* Td6 TURBOCHARGED V6

The Td6 engine delivers exceptional performance and efficiency. It achieves 0-60mph in 7.1 seconds** with 440 lb.ft of torque.

GASOLINE ENGINES

340 HP* SUPERCHARGED V6

This Supercharged V6 engine delivers an impressive 340 hp and 332 lb.ft of torque with a maximum speed of 130mph**.

380 HP* SUPERCHARGED V6 (HST MODEL ONLY)

The powerful 380 hp Supercharged V6 delivers an additional 40 hp compared with the 340 hp engine.

510 HP* SUPERCHARGED V8

This Supercharged V8 delivers exhilarating performance and a 0-60mph in just 5 seconds** on a power output of 510 hp and 461 lb.ft of torque, all achieved with supreme refinement.

The V8 has a compact and lightweight all-aluminum design, with extremely low levels of internal friction. The engine is optimized around a Bosch engine management system. This features high-pressure direct injection with centrally mounted, multi-hole, sprayguided injection system.

The 510 hp engine is fitted with a sixth generation, **Twin Vortex System (TVS)** supercharger that offers thermodynamic efficiency and refined noise levels.

SVR 550 HP* SUPERCHARGED V8

Range Rover Sport SVR goes from 0-60mph in 4.5 seconds**. It has a top speed of 162mph*. Its 5.0 liter Supercharged V8 gasoline engine delivers 550 hp and 502 lb.ft.

This breath-taking performance is enabled by a recalibration of the engine and its management system which includes an increase in maximum available boost pressure. Maximum torque is delivered at 3,500-4,000rpm.

*Horsepower figure is Manufacturer's estimate **Always follow local speed limits.
Vehicle shown right is SVR in Estoril Blue with Santorini Contrast Roof.



ABOVE & BEYOND

> FIND A RETAILER

> BUILD YOUR OWN

OVERVIEW

SPECIFICATION



ENGINES

43

DESIGN

DRIVING TECHNOLOGY

FINISHING TOUCHES

POWERTRAINS

BODY AND CHASSIS

DRIVING ASSISTANCE

ENVIRONMENTAL





ABOVE & BEYOND

> FIND A RETAILER

> BUILD YOUR OWN

OVERVIEW

SPECIFICATION

BODY AND CHASSIS

ALL-ALUMINUM BODY

A category first, the all-aluminum unibody structure makes the vehicle lighter, stronger, fuel efficient and sustainable. Being lighter also improves both acceleration and agility for a refined driving experience.

The body has been engineered to withstand the same off-road use as all Land Rover vehicles. Using aerospace inspired bonding and riveting technologies means that traditional energy intensive construction methods, such as spot welding, are not required.

To create such a weight-efficient body, the structure features a rigorously optimized combination of stamped, cast and extruded aluminum alloy components, so that the strength of the bodyshell is concentrated precisely where the loads are greatest.

This results in a structure which delivers outstanding stiffness and refinement together with excellent safety performance.

This structure is supported by an alloy front and rear suspension designed to deliver a much broader range of dynamic capabilities across all terrains.

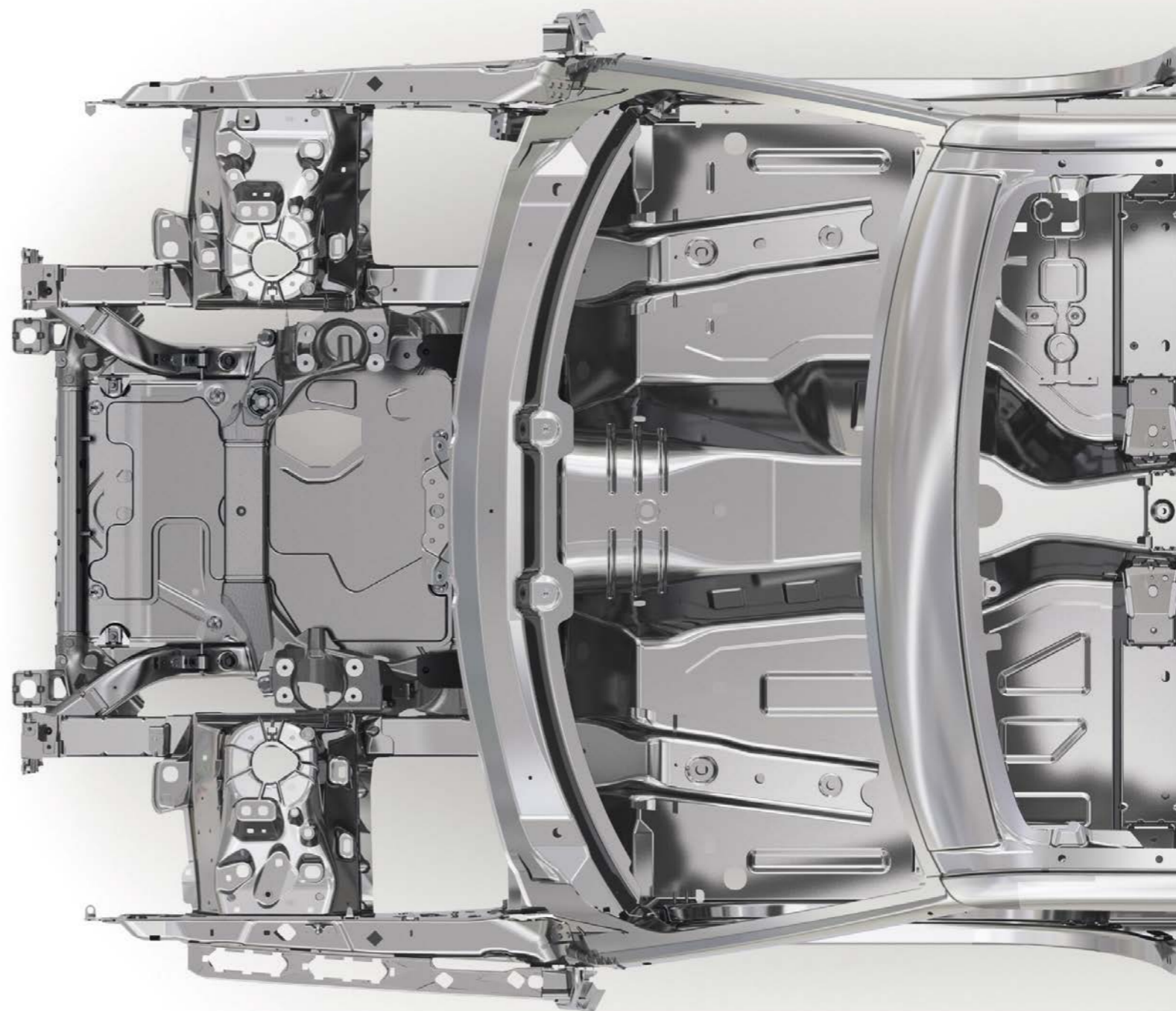



ABOVE & BEYOND

> FIND A RETAILER

> BUILD YOUR OWN

OVERVIEW

SPECIFICATION

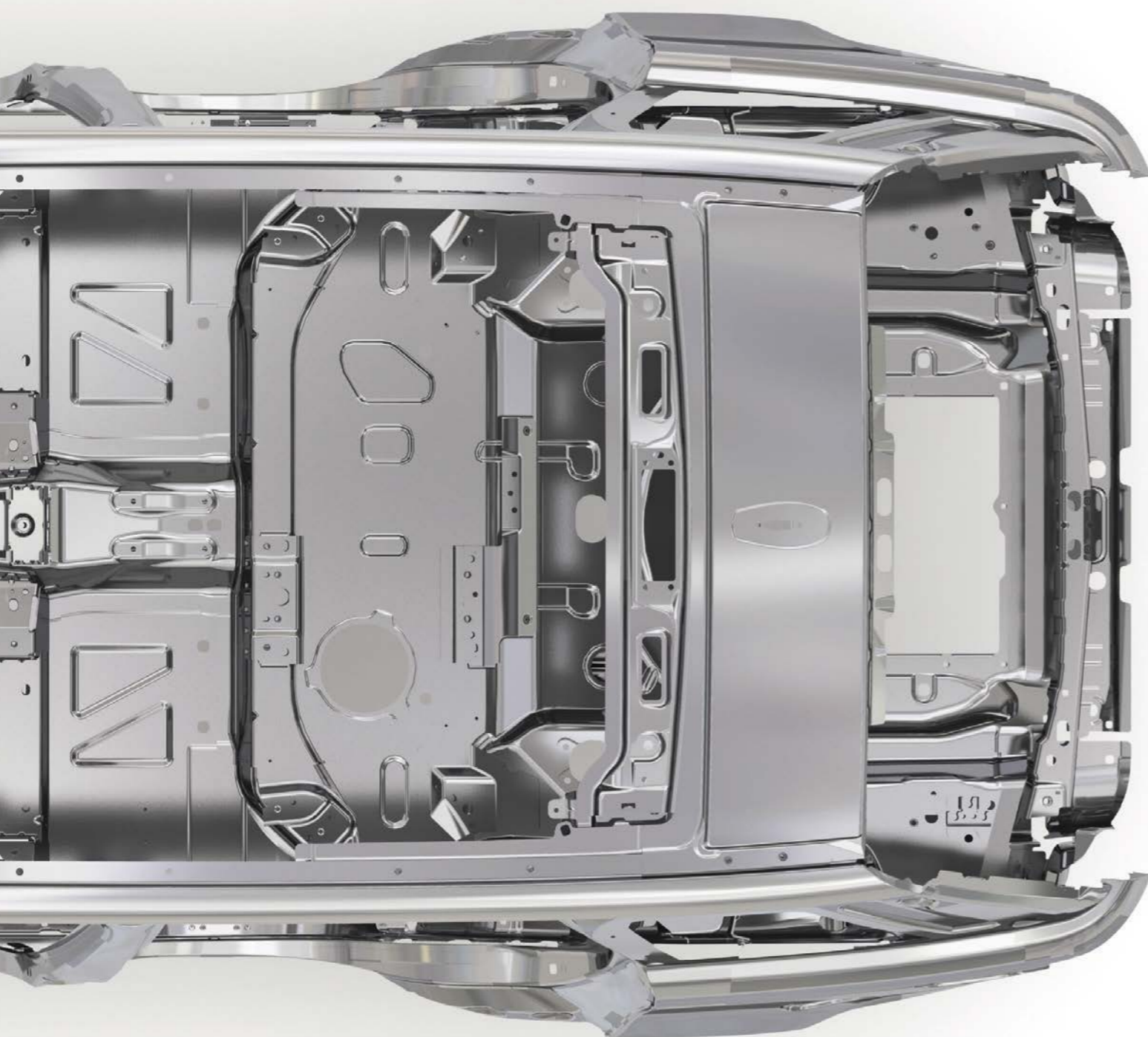

SUSPENSION

Primarily constructed from aluminum components, the suspension is fully independent, with a wide-spaced double-wishbone design at the front and an advanced multi-link layout at the rear.

The suspension concept is specifically developed to maximize the unrivalled breadth of capability of the Range Rover Sport, offering responsive and agile handling together with supreme ride quality and refinement.

SVR

Range Rover Sport has been praised for its high levels of comfort and extremely agile handling. SVR takes that capability to the next level. The SVR chassis is tuned to provide quicker responses, tighter body control, higher cornering velocities and an increased sense of connection to the road.



ABOVE & BEYOND

> FIND A RETAILER

> BUILD YOUR OWN

OVERVIEW

SPECIFICATION

ENGINEERED FOR MAXIMUM OCCUPANT PROTECTION

The aluminum body structure protects occupants using an incredibly strong and stable safety cell.

The crash structure is extensively optimized using computer simulation tools, which allows engineers to conduct a significant number of 'virtual' crash tests long before physical prototypes are available.

The occupant safety package includes a comprehensive system of airbags and restraint systems including driver and passenger airbags, side curtain and thorax airbags and active front seat belts which are linked to the vehicle's emergency braking functions.

DRIVING ASSISTANCE

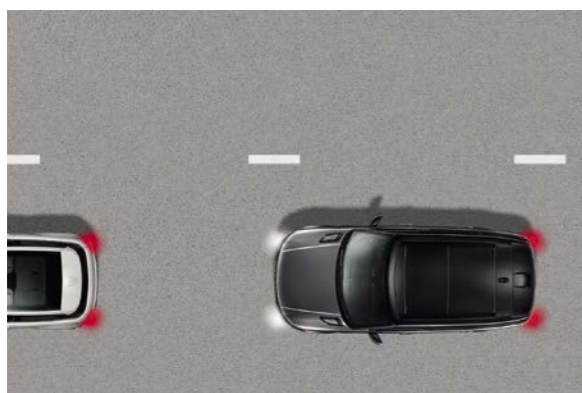

ADAPTIVE CRUISE CONTROL WITH QUEUE ASSIST*

Adaptive Cruise Control (ACC) is an optional system that helps maintain a pre-set gap from the vehicle in front, even if it changes speed. Queue Assist extends the ACC functionality. It is designed to allow the vehicle to come to a stop when it reaches a traffic jam.

Intelligent Emergency Braking uses radar to detect vehicles travelling in the same direction and is designed to automatically reduce impact speed if it calculates that a frontal collision is unavoidable (optional on all models).



BLIND SPOT MONITORING WITH CLOSING VEHICLE SENSING*

Using sensors mounted on the sides and the rear bumper, these systems are integrated to see what you might miss. When a vehicle enters a blind spot, an amber warning light shows in the corresponding door mirror.

Closing Vehicle Sensing scans a zone much further behind the vehicle, to help detect vehicles which are closing quickly from behind, and which could cause a threat during a lane change maneuver (included in Climate Comfort and Visibility Package).

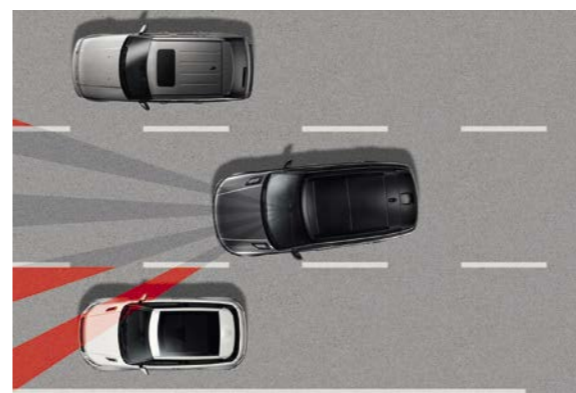

LANE DEPARTURE WARNING*

This feature notifies the driver when the vehicle is leaving the road or drifting into traffic in an adjacent lane. The system warns the driver using an alert on the cluster and vibration feedback through the steering wheel; it encourages better lane discipline by warning of inattention to the road. A drift is defined as the vehicle driving over a lane marking without using the indicator, the system uses a front facing camera to determine if this is the case. The system is active at speeds of 30-95mph and where the lane being driven in is more than 8.2 ft wide (included in Driver Assistance Package).



TRAFFIC SIGN RECOGNITION*

Traffic Sign Recognition uses the forward facing camera to read speed limit signs and displays the identified speed limit on the instrument cluster. The system is capable of detecting variable speed limits and, where it exists, navigation data is used to increase its effectiveness. The feature can also display overtaking restrictions. Available as an option (included in Driver Assistance Package).

*These systems are not a substitute for driving safely with due care and attention and will not function under all circumstances, speeds, weather and road conditions, etc. Driver should not assume that these systems will correct errors of judgment in driving. Please consult the owner's manual or your local authorized Land Rover Retailer for more details.



ABOVE & BEYOND

> FIND A RETAILER

> BUILD YOUR OWN

OVERVIEW

SPECIFICATION



REVERSE TRAFFIC DETECTION*

Using detectors in the rear of the vehicle, this optional system is designed to warn you about potential collisions during reversing maneuvers. The system can help detect a vehicle approaching from either side. When a target vehicle with a credible 'time to collision' is detected (a collision within three seconds or less), the system alerts corresponding door mirror, an audible alert is sounded and a warning symbol is displayed on the camera screen. (Included in Climate Comfort and Visibility Package).

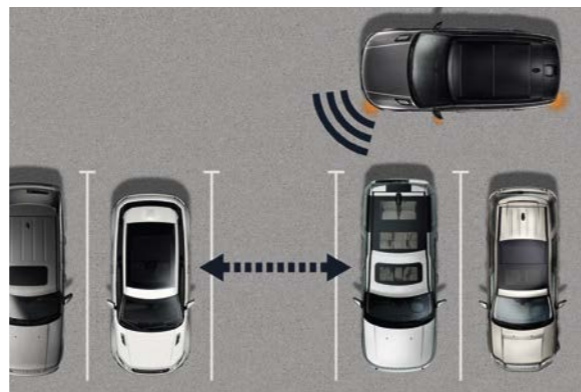

PARK ASSIST FEATURES*

Parking is made simpler with the aid of Park Assist, an optional feature which can be further enhanced with the addition of **Parking Exit, Perpendicular Parking and 360° Park Distance Control** (Included in Driver Assistance Package).

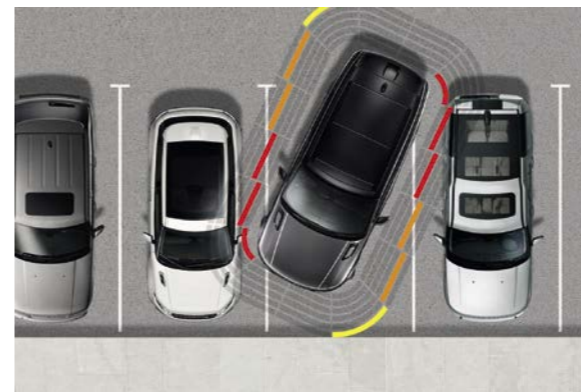

360° PARK DISTANCE CONTROL*

With virtual object tracking along the sides of the vehicle, 360° Park Distance Control gives confidence in confined situations, like multi-storey parking garages at speeds up to 10mph. (Included in Driver Assistance Package).



ADAPTIVE XENON HEADLAMPS*

Optional Xenon lights with LED signature design combine distinctive design with highly practical capabilities: Adaptive Xenon lamps swivel to follow the road, and light the curbside area in tight bends to give the driver a greater sense of confidence during night-time driving. (Included in Climate Comfort and Visibility Package. Standard on Autobiography).



ABOVE & BEYOND

> FIND A RETAILER

> BUILD YOUR OWN

OVERVIEW

SPECIFICATION





ABOVE & BEYOND

> FIND A RETAILER

> BUILD YOUR OWN

OVERVIEW

SPECIFICATION



ENVIRONMENTAL

SUSTAINABILITY

EFFICIENCY DRIVES SUSTAINABILITY

Range Rover Sport demonstrates the Land Rover commitment to enhancing the sustainability of its products and operations. With its lightweight aluminum structure and optimized powertrains Range Rover Sport addresses the growing consumer need for more socially acceptable vehicles in a carbon-conscious world.

Its greener credentials stem from a comprehensive approach to reducing environmental impact throughout the life cycle of the vehicle, from development and manufacturing, to customer use and end-of-life.

SUSTAINABLE BY DESIGN, WITH LIFE CYCLE APPROACH

In order to minimize the vehicle's overall ecological impact, Range Rover Sport is designed with a life cycle approach, aiming to minimize the environmental impact by considering the entire life cycle of the vehicle.

Each element of the life cycle was analyzed with a view to consuming fewer natural resources, using more sustainable materials and minimizing the generation of waste.

The development process has included a full life cycle assessment in line with ISO 14040/14044.

The Range Rover Sport aluminum construction makes a major contribution to its reduced carbon footprint. Up to 75 percent of the aluminum material is sourced from recycled content, resulting in a significant saving of energy and CO₂ emissions.

Recycled and renewable materials are used wherever possible in the Range Rover Sport. High specification vehicles use up to 59 lbs of recycled plastics, diverting over 14,330 tons of plastic from landfill during the vehicle's production. Natural and renewable materials, such as the luxurious leathers and veneers, represent 62 lbs of each vehicle.

INTELLIGENT STOP START SYSTEM

To ensure the greatest possible fuel efficiency, all Range Rover Sport powertrains incorporate low-CO₂ technologies such as the advanced intelligent Stop/Start system, which improves fuel consumption by between 5 and 7 percent. The system automatically stops the engine instead of idling and resumes as soon as you lift your foot off the brake. It features a **Tandem Solenoid Starter** with a dedicated secondary battery for instant restarting.

Vehicle shown left is Autobiography in Corris Grey.



ABOVE & BEYOND

> FIND A RETAILER

> BUILD YOUR OWN

OVERVIEW

SPECIFICATION

RANGE ROVER SPORT OFFERS GREAT OPTIONS AND FLEXIBILITY TO PERSONALIZE YOUR VEHICLE.

The following pages take you through a logical series of steps to create Range Rover Sport to suit your lifestyle. There are lots of choices: from selecting your engine and model to exterior and interior colors, wheels, finishes and those detailed touches to enable you to make Range Rover Sport truly yours.

If you would like to bring your options to life, go to our online configurator at LandRoverUSA.com

52-53

1

**STEP 1
CHOOSE YOUR ENGINE**

You can select from a powerful range of gasoline and diesel engines.

54-67

2

**STEP 2
CHOOSE YOUR MODEL**

Compare the standard and optional features on each model.





ABOVE & BEYOND

> FIND A RETAILER

> BUILD YOUR OWN

OVERVIEW

SPECIFICATION

68-69

70-71

72-81

82-91

3

4

5

6

**STEP 3
CHOOSE YOUR COLOR**

There is a wide range of colors offered to enable you to express yourself.

**STEP 4
CHOOSE YOUR WHEELS**

There is a great choice of styles, each one designed to complement the bold exterior.

**STEP 5
CHOOSE YOUR INTERIOR**

Carefully selected colors complemented by the finest wood and metal trim. You can personalize your interior space.

**STEP 6
CHOOSE YOUR ACCESSORIES**

This range of stylish and practical accessories can be tailored to suit any lifestyle.

92-93

TECHNICAL DETAILS

Technical information and data for dimensions, performance and specifications.



ABOVE & BEYOND

> FIND A RETAILER

> BUILD YOUR OWN

OVERVIEW

SPECIFICATION

1





ABOVE & BEYOND

> FIND A RETAILER

> BUILD YOUR OWN

OVERVIEW

SPECIFICATION

STEP 1
CHOOSE YOUR ENGINE

	DIESEL	GASOLINE			
	3.0L V6 TD6 TURBOCHARGED	3.0L V6 SUPERCHARGED	3.0L V6 SUPERCHARGED	5.0L V8 SUPERCHARGED	5.0L V8 SUPERCHARGED SVR
	AUTOMATIC	AUTOMATIC	AUTOMATIC	AUTOMATIC	AUTOMATIC
POWER HP	254*	340*	380*	510*	550*
Driveline	Four Wheel Drive (4WD)	Four Wheel Drive (4WD)	Four Wheel Drive (4WD)	Four Wheel Drive (4WD)	Four Wheel Drive (4WD)
Maximum power hp / rpm	254 / 4,000	340 / 6,500	380 / 6,500	510 / 6,000 – 6,500	550 / 6,000 – 6,500
Maximum torque (lb-ft / rpm)	440 / 2,000	332 / 3,500 – 5,000	332 / 3,500 – 5,000	461 / 2,500 – 5,500	502 / 3,500 – 4,000
Capacity (cc)	2,993	2,995	2,995	5,000	5,000
No. of cylinders	6	6	6	8	8
Cylinder layout	Longitudinal 60 Degree V6	Longitudinal 90 Degree V6	Longitudinal 90 Degree V6	Longitudinal 90 Degree V8	Longitudinal 90 Degree V8

MODELS BY ENGINE

	SE	HSE	HST	SUPERCHARGED	SUPERCHARGED DYNAMIC	AUTOBIOGRAPHY	SVR
254 hp* Td6 Turbocharged 3.0L V6 (Diesel)	■	■					
340 hp* Supercharged 3.0L V6 (Gasoline)	■	■					
380 hp* Supercharged 3.0L V6 (Gasoline)			■				
510 hp* Supercharged 5.0L V8 (Gasoline)				■	■	■	
550 hp* Supercharged 5.0L V8 (Gasoline)							■

*Horsepower figure is Manufacturer's estimate.

Visit LandRoverUSA.com for more information.



ABOVE & BEYOND

> FIND A RETAILER

> BUILD YOUR OWN

OVERVIEW

SPECIFICATION

2

EACH MODEL HAS A CHOICE OF ENGINES AND UNIQUE FEATURES.

Each model has a choice of engines and unique features. This guide will help you to select your ideal Range Rover Sport. On the following pages you will see the standard features for each model, including the new HST model on pages 56 and 57.

RANGE ROVER SPORT SE



- 254 hp* Td6 Turbocharged 3.0L (Diesel) or 340 hp* Supercharged 3.0L V6 (Gasoline) engine
- Single speed transfer case
- Grille in Dark Atlas with Gloss Black surround
- Fender vent with Dark Atlas fingers, Satin Black mesh and Gloss Black surround
- Body colored upper mirror caps
- 19 inch five split-spoke 'Style 501' alloy wheels
- Seats in Grained leather.

RANGE ROVER SPORT HSE



- 254 hp* Td6 Turbocharged 3.0L (Diesel) or 340 hp* Supercharged 3.0L V6 (Gasoline) engine
- Single speed transfer case
- Grille in Atlas with Gloss Black surround
- Fender vent with Atlas fingers, Atlas mesh and Gloss Black surround
- Body colored upper mirror caps
- Front fog lamps
- 20 inch five split-spoke 'Style 520' alloy wheels
- Seats in Oxford Perforated leather
- Fixed panoramic roof.

*Horsepower figure is Manufacturer's estimate **These systems are not a substitute for driving safely with due care and attention and will not function under all circumstances, speeds, weather and road conditions, etc. Driver should not assume that these systems will correct errors of judgment in driving. Please consult the owner's manual or your local authorized Land Rover Retailer for more details.



ABOVE & BEYOND

> FIND A RETAILER

> BUILD YOUR OWN

OVERVIEW

SPECIFICATION

STEP 2
CHOOSE YOUR MODEL

RANGE ROVER SPORT SUPERCHARGED



- 510 hp* Supercharged 5.0L V8 engine (Gasoline)
- Two Speed transfer case
- Grille in Atlas with Gloss Black surround
- Fender vent with Atlas fingers, Atlas mesh and Gloss Black surround
- Body colored upper mirror caps
- 20 inch five split-spoke 'Style 520' alloy wheels
- Seats in Oxford Perforated leather
- Sliding panoramic roof
- Paddle Shift
- Torque Vectoring
- Dynamic Response™**
- Terrain Response® 2*
- Bright twin tailpipes
- Aluminum treadplates with Range Rover branding
- Supercharged Dynamic includes 21 inch five split-spoke 'Style 507' with Diamond Turned finish alloy wheels.

RANGE ROVER SPORT AUTOBIOGRAPHY



- 510 hp* Supercharged 5.0L V8 engine (Gasoline)
- Two Speed transfer case
- Grille in Gloss Black painted mesh with Gloss Black surround
- Fender vent with Gloss Black fingers, Atlas mesh and Gloss Black surround
- Gloss Black upper mirror caps
- Tailgate trim in Gloss Black
- 21 inch five split-spoke 'Style 505' alloy wheels
- Red Brembo™ branded brake calipers
- Seats in Oxford Perforated leather with unique pattern and stitching
- Exclusive interior color themes available for Autobiography models: Espresso/Ivory/Tan and Ebony/Lunar/Cirrus
- Sliding panoramic roof
- Meridian™ Surround Sound Audio System (825W) with 19 speakers.

RANGE ROVER SPORT SVR



- 550 hp* Supercharged 5.0L V8 engine (Gasoline)
- Unique grille in Gloss Black painted mesh with Gloss Black surround
- Distinct design of fender vent in Gloss Black
- Gloss Black upper mirror caps
- Unique design of front and rear bumpers
- Lower front bumper grille insert and tow eye covers in Gloss Black (Corris Grey when exterior color is Fuji White, Yulong White or Indus Silver)
- Tailgate trim in Gloss Black
- 21 inch five split-spoke 'Style 517' alloy wheels
- Range Rover script in Gloss Black
- Darkened headlamps with Gloss Black finish to non-reflective surfaces
- Specialized rear spoiler
- Bright quad tailpipes
- Blue Brembo™ branded brake calipers
- Sports seats in Oxford Perforated leather with SVR Pattern
- Available in four interior color themes.

Visit LandRoverUSA.com for more information.



ABOVE & BEYOND

> FIND A RETAILER

> BUILD YOUR OWN

OVERVIEW

SPECIFICATION



ENGINES

MODELS

COLORS

WHEELS

INTERIORS

ACCESSORIES

TECHNICAL DETAILS





ABOVE & BEYOND

> FIND A RETAILER

> BUILD YOUR OWN

OVERVIEW

SPECIFICATION

STEP 2
CHOOSE YOUR MODEL

HST

The bold new Range Rover Sport HST is identified by its unique exterior and interior design which gives this high-performance luxury SUV a distinctive and dynamic appearance. Underneath the exterior, the upgraded 3.0L Supercharged V6 engine provides 380 hp, an additional 40 hp over the standard Supercharged V6 engine.

A striking Gloss Black theme is the hallmark of the exterior including; mirror caps, hood and tailgate lettering, grille and surround, hood louvres and door handle surrounds. HST is fitted with darkened front and rear lamps, which feature non-reflective surrounds and combine with a Santorini Black contrast roof and a new spoiler to give the vehicle a purposeful profile. In common with other Dynamic Range Rover Sport

models, the HST wears a red Sport badge at the rear, complemented by unique HST badging on the Gloss Black side vents.

There are five exclusive interior color themes available on the Oxford Perforated leather seats. Choices include; Ebony/Cirrus, Ebony/Pimento, Ebony/Lunar, Ebony/Tan, there is also an all-Ebony interior option.

The HST features standard 21 inch Dark Satin Grey alloy wheels and Red Brembo™ branded brake calipers. Available as an option are 22 inch Satin Black alloy wheels.



Gloss Black Grille and Lettering



Gloss Black Tailgate Trim



Door handles with Gloss Black Trim



Gloss Black side vents with HST badge

Visit LandRoverUSA.com for more information.

57

ENGINES

MODELS

COLORS

WHEELS

INTERIORS

ACCESSORIES

TECHNICAL DETAILS



ABOVE & BEYOND

> FIND A RETAILER

> BUILD YOUR OWN

OVERVIEW

SPECIFICATION

STANDARD AND OPTIONAL FEATURES

Engine Transmission, Suspension and Driving Dynamics

	OPTION CODE	SE	HSE	HST	SUPERCHARGED	SUPERCHARGED DYNAMIC	AUTOBIOGRAPHY	SVR
Eight-speed Automatic Transmission with CommandShift 2		■	■	■	■	■	■	■
Single speed Transfer Case (high range only)		■	■	■	-	-	-	-
Two Speed Transfer Case (high/low range) (optional as part of the Extra Duty Package)	043BF	□	□	-	■	■	■	■
Extra Duty Package – includes two speed transfer case, ATPC and Terrain Response 2 and Adaptive Dynamics	074QA	□	□	-	-	-	-	-
Electronic cross linked air suspension with automatic load leveling		■	■	■	■	■	■	■
Four Corner Air Suspension		■	■	■	■	■	■	■
Terrain Response® (Terrain Response Dynamic Program for HST)		■	■	■	-	-	-	-
Terrain Response® 2 (1)	088IA	□	□	-	■	■	■	■
Terrain Response® 2 Dynamic Program		-	-	-	-	■	■	■
Adaptive Dynamics* (optional as part of the Extra Duty Package)		□	□	■	■	■	■	■
Dynamic Response*		-	-	-	■	■	■	■
Torque Vectoring*		-	-	-	■	■	■	■
Intelligent Stop/Start System		■	■	■	■	■	■	■
Speed proportional Electric Power Assisted Steering (EPAS)*		■	■	■	■	■	■	■
Paddle Shift		-	-	-	■	■	-	-
Noble Plated Paddle Shift	078CC	-	-	■	-	-	■	■
Standard finish brake calipers (size of brake calipers fitted is dependent on engine selected)	020BG	■	■	-	Δ	Δ	Δ	-
Red Brembo™ branded brake calipers (front only, non-branded rear)		-	-	■	■	■	■	-
Blue Brembo™ branded brake calipers (front only, non-branded rear)		-	-	-	-	-	-	■
Electric Parking Brake (EPB)*		■	■	■	■	■	■	■
Anti-lock Braking System (ABS)*		■	■	■	■	■	■	■
Cornering Brake Control (CBC)*		■	■	■	■	■	■	■
Dynamic Stability Control (DSC)*		■	■	■	■	■	■	■

■ Standard □ Optional – Not Available Δ No Cost Option
 (1) Requires twin speed transfer box.



ABOVE & BEYOND

> FIND A RETAILER

> BUILD YOUR OWN

OVERVIEW

SPECIFICATION

STEP 2
CHOOSE YOUR MODEL

Engine Transmission, Suspension and Driving Dynamics (continued)

	OPTION CODE	SE	HSE	HST	SUPERCHARGED	SUPERCHARGED DYNAMIC	AUTOBIOGRAPHY	SVR
Electronic Brake-force Distribution (EBD)*		■	■	■	■	■	■	■
Emergency Brake Assist (EBA)*		■	■	■	■	■	■	■
Electronic Traction Control (ETC)*		■	■	■	■	■	■	■
Gradient Release Control (GRC) and Gradient Acceleration Control (GAC)*		■	■	■	■	■	■	■
Hill Descent Control (HDC®)*		■	■	■	■	■	■	■
Reactive Grounding Response*		■	■	■	■	■	■	■
All-Terrain Progress Control* (2) (only available as part of the Extra Duty Package)	095CB	□	□	-	■	■	■	-

Exterior Features and Finishers

	OPTION CODE	SE	HSE	HST	SUPERCHARGED	SUPERCHARGED DYNAMIC	AUTOBIOGRAPHY	SVR
ROOF AND EXTERIOR STYLING								
Metal roof	041CY	■	Δ	-	Δ	Δ	Δ	Δ
Body colored roof		■	■	-	■	■	■	■
Roof rack mounting provisions		■	■	■	■	■	■	■
Body colored upper mirror caps		■	■	-	■	-	-	-
Gloss Black upper mirror caps		-	-	■	-	■	■	■
Body colored side sills and bumpers		□	□	■	□	□	■	■
Sliding panoramic roof	041CZ	-	□	■	■	■	■	■
Fixed panoramic roof	041CX	□	■	-	-	-	-	Δ
Contrast roof – Corris Grey	080EE	□	□	-	□	□	Δ	-
Contrast roof – Indus Silver	080AD	□	□	-	□	□	Δ	-
Contrast roof – Santorini Black	080AN	□	□	■	□	□	Δ	Δ

■ Standard □ Optional - Not Available Δ No Cost Option

(2) Requires Terrain Response 2 .

*These systems are not a substitute for driving safely with due care and attention and will not function under all circumstances, speeds, weather and road conditions, etc. Driver should not assume that these systems will correct errors of judgment in driving. Please consult the owner's manual or your local authorized Land Rover Retailer for more details.

Visit LandRoverUSA.com for more information.



ABOVE & BEYOND

> FIND A RETAILER

> BUILD YOUR OWN

OVERVIEW

SPECIFICATION

STANDARD AND OPTIONAL FEATURES

Exterior Features and Finishers (continued)

	OPTION CODE	SE	HSE	HST	SUPERCHARGED	SUPERCHARGED DYNAMIC	AUTOBIOGRAPHY	SVR
GLASS AND EXTERIOR MIRRORS								
Acoustic laminated front windshield		■	■	■	■	■	■	■
Privacy glass with solar attenuating windshield		■	■	■	■	■	■	■
Heated windshield	040AK	□	□	■	□	□	■	■
Power windows (front and rear) with auto close		■	■	■	■	■	■	■
Rain sensing windshield wipers		■	■	■	■	■	■	■
Heated wiper park position (manual lift away from windshield)		■	■	■	■	■	■	■
Heated rear window		■	■	■	■	■	■	■
Power adjustable, heated powerfold exterior mirrors with approach lamps (3)		■	■	■	■	■	-	-
Power adjustable, heated powerfold exterior mirrors with approach lamps and auto-dimming (3) (4)	031EB	□	□	■	□	□	■	■
HEADLAMPS AND LIGHTING								
Front fog lamps	064AP	□	■	■	■	■	■	-
Xenon headlamps with LED signature (includes headlamp powerwash)		■	■	■	■	■	-	-
Adaptive Xenon headlamps with LED signature (includes headlamp powerwash)*	064DI	□	□	■	□	□	■	■
Automatic headlamps with High Beam Assist (AHBA)* (requires Xenon or Adaptive Xenon headlamps)	030NT	□	□	■	□	□	■	■
Follow-me-home lighting		■	■	■	■	■	■	■
Side repeater indicators in mirror		■	■	■	■	■	■	■
Hazard lights under heavy braking		■	■	■	■	■	■	■

■ Standard □ Optional - Not Available Δ No Cost Option

(3) Includes memory function when ordered with seats with memory (4) Only available with auto-dimming exterior mirrors.



ABOVE & BEYOND

> FIND A RETAILER

> BUILD YOUR OWN

OVERVIEW

SPECIFICATION

STEP 2
CHOOSE YOUR MODEL

Exterior Features and Finishers (continued)

	OPTION CODE	SE	HSE	HST	SUPERCHARGED	SUPERCHARGED DYNAMIC	AUTOBIOGRAPHY	SVR
PAINT								
Solid Paint		□	□	□	□	□	□	□
Metallic Paint	024AZ	□	□	□	□	□	□	□
Premium Metallic Paint	024BR	□	□	□	□	□	□	□
TOWING								
Trailer stability control*		■	■	■	■	■	■	■
7,716lbs towing capacity		■	■	■	■	■	■	-
6,614lbs towing capacity		-	-	-	-	-	-	■
Drivers Assistance Package – includes Land Departure Warning with Traffic Sign Recognition, Head Up Display, InControl Wi-Fi and Park Assist	028CA	□	□	-	□	□	□	□
WHEELS AND WHEEL OPTIONS								
19 inch five split-spoke 'Style 501'	029SA	■	Δ	-	-	-	-	-
19 inch five split-spoke 'Style 501' with Satin Dark Grey finish	029XR	□	Δ	-	-	-	-	-
20 inch five split-spoke 'Style 520'	029YT	□	■	-	■	Δ	Δ	-
21 inch five split-spoke 'Style 507'	029YU	□	□	-	□	Δ	Δ	-
21 inch five split-spoke 'Style 507' with Diamond Turned finish	029YV	-	-	-	-	■	□	-
21 inch five split-spoke 'Style 505'	029SW	-	-	-	-	-	■	-
21 inch five split spoke 'Style 517'	029TT	-	-	-	-	-	-	■
21 inch five split-spoke 'Style 507' with Satin Dark Grey finish		-	-	■	-	-	-	-
22 inch five split-spoke 'Style 504'	029SF	□	□	-	□	□	□	-
22 inch ten split-spoke 'Style 108'	029TU	-	-	-	-	-	-	□
Tire Pressure Monitoring System (TPMS)		■	■	■	■	■	■	■
Tire repair system	029FJ	□	□	-	Δ	□	□	□
Reduced section spare wheel	029QQ	■	■	■	■	■	■	Δ
Full size spare wheel	050AQ	□	□	□	□	□	□	-

■ Standard □ Optional - Not Available Δ No Cost Option

*These features are not a substitute for driving safely with due care and attention and will not function under all circumstances, speeds, weather and road conditions, etc. Driver should not assume that these features will correct errors of judgment in driving. Please consult the owner's manual or your local authorized Land Rover Retailer for more details.

Visit LandRoverUSA.com for more information.



ABOVE & BEYOND

> FIND A RETAILER

> BUILD YOUR OWN

OVERVIEW

SPECIFICATION

STANDARD AND OPTIONAL FEATURES

Seating, Interior Features and Finishers

	OPTION CODE	SE	HSE	HST	SUPERCHARGED	SUPERCHARGED DYNAMIC	AUTOBIOGRAPHY	SVR
SEATING								
Grained leather		■	-	-	-	-	-	-
Oxford Perforated leather		-	■	-	■	■	-	-
Oxford Perforated leather with Autobiography Pattern (Single / Duo / Tri tone)		-	-	■	-	-	■	-
Oxford Perforated Leather with SVR pattern (Single / Duo tone)		-	-	-	-	-	-	■
14-way / 14-way powered seats with memory and manual headrest		■	■	-	■	■	-	-
16-way / 16-way powered seats with memory (optional as part of a package)	033SZ	-	□	■	□	□	■	-
16-way / 16-way SVR sports powered front seats with memory		-	-	-	-	-	-	■
Heated front seats		-	■	-	■	■	-	-
Heated front seats with heated rear seats (optional as part of a package)	033EQ	□	-	-	-	-	-	■
Climate front seats with heated rear seats (optional as part of a package)	033GQ	-	□	■	□	□	■	-
Climate front seats with climate rear seats (optional as part of a package)	033IN	-	□	-	□	□	□	-
60:40 Folding rear seats		■	■	-	■	■	-	■
60:40 folding rear seats with load through	033CW	□	□	■	□	□	■	-
Powered 5+2 seating (1)	033BI	□	□	-	□	□	□	-
5+2 Seating Package	033YB	□	-	-	-	-	-	-
Head restraints two-way adjust		■	■	■	■	■	■	■
LATCH/ISOFIX seat anchors		■	■	■	■	■	■	■
Second row manual recline		■	■	■	■	■	■	■

■ Standard □ Optional - Not Available Δ No Cost Option

(1) Not available with 19 inch or 20 inch alloy wheels. Requires 60:40 load through and Tire Repair System.



ABOVE & BEYOND

> FIND A RETAILER

> BUILD YOUR OWN

OVERVIEW

SPECIFICATION

STEP 2
CHOOSE YOUR MODEL

Seating, Interior Features and Finishers (continued)

	OPTION CODE	SE	HSE	HST	SUPERCHARGED	SUPERCHARGED DYNAMIC	AUTOBIOGRAPHY	SVR
STEERING WHEEL								
Power adjustable steering column (entry and exit tilt away with reach / rake on steering wheel)		■	■	■	■	■	■	■
Leather steering wheel with multi-functional controls		■	■	-	■	■	-	-
Leather heated steering wheel (optional as part of a package)	032FB	□	□	■	□	□	■	■
Leather heated steering wheel with Carbon Fiber bezel*	032FD	-	-	-	-	-	-	□
INTERIOR FINISHERS								
Dark Brushed aluminum Trim finisher		■	-	-	-	-	-	-
Micro Mesh aluminum Trim finisher	088HQ	-	Δ	Δ	Δ	-	-	-
Sport Textured aluminum Trim finisher	088HR	-	-	■	-	Δ	-	-
Dark Engine Turned aluminum Trim finisher	088GP	-	-	□	-	-	Δ	■
Shadow Zebrano Wood Veneer finisher (2)	088HB	□	■	□	■	■	■	-
Dark Grey Oak Wood Veneer finisher (2)	088GM	□	Δ	□	Δ	Δ	Δ	-
Grand Black Wood Veneer finisher	088HS	-	□	□	□	□	□	-
Carbon Fiber Veneer finisher	088JF	-	-	-	-	-	-	□
HEADLINING								
Morzine headlining (Cirrus or Ivory dependent on colorway)		■	■	■	■	■	■	■
Morzine headlining (Ebony)	005BJ	□	□	Δ	□	□	□	□

■ Standard □ Optional - Not Available Δ No Cost Option

*Only available with Carbon Fiber Veneer Finisher

(2) For availability please see pages 74 and 75 for the color and trim matrix.

Visit LandRoverUSA.com for more information.



ABOVE & BEYOND

> FIND A RETAILER

> BUILD YOUR OWN

OVERVIEW

SPECIFICATION

STANDARD AND OPTIONAL FEATURES

Seating, Interior Features and Finishers (continued)

	OPTION CODE	SE	HSE	HST	SUPERCHARGED	SUPERCHARGED DYNAMIC	AUTOBIOGRAPHY	SVR
INTERIOR FEATURES								
Single blade sunvisor		■	■	■	■	■	-	-
Twin blade sunvisor (optional as part of a package)	115AP	□	□	■	□	□	■	■
Auto-dimming interior mirror		■	■	■	■	■	■	■
Front and rear carpet mats		■	■	-	■	■	-	-
Front and rear premium carpet mats	079CA	-	-	-	-	□	■	■
Aluminum treadplates with Range Rover lettering		-	■	-	■	■	■	■
Illuminated aluminum treadplates with Range Rover lettering		-	-	■	-	-	-	-
Bright metal sports pedals		-	-	■	-	■	■	■
Front center console cooler compartment (optional as part of a package)	038EA	-	□	-	□	□	■	△
Two-zone climate control		■	■	■	■	■	-	-
Three-zone climate control (optional as part of a package)		-	-	-	-	-	■	■
Four-zone climate control	022BG	-	□	-	□	□	□	-
Interior mood lighting (optional as part of a package)		■	■	■	■	■	-	-
Configurable mood lighting	064FC	□	□	-	□	□	■	■
Driver and passenger sunvisor with illuminated vanity mirror		■	■	■	■	■	■	■
Center armrest with cubby box		■	■	■	■	■	■	■
Front and rear grab handles		■	■	■	■	■	■	■
Front and rear cupholders		■	■	■	■	■	■	■
Secure glove box storage		■	■	■	■	■	■	■
Smokers Pack (Front and rear cigar lighter and ash tray)	094AA	△	△	△	△	△	△	△

■ Standard □ Optional - Not Available △ No Cost Option



ABOVE & BEYOND

> FIND A RETAILER

> BUILD YOUR OWN

OVERVIEW

SPECIFICATION

STEP 2
CHOOSE YOUR MODEL

Safety and Security

	OPTION CODE	SE	HSE	HST	SUPERCHARGED	SUPERCHARGED DYNAMIC	AUTOBIOGRAPHY	SVR
Single point entry, customer configurable		■	■	■	■	■	■	■
Power operated child locks		■	■	■	■	■	■	■
Push button keyless Start/Stop		■	■	■	■	■	■	■
Driver and Passenger Airbags (side, seat-front, thorax, pelvis)*		■	■	■	■	■	■	■
Roll Stability Control (RSC)**		■	■	■	■	■	■	■
Active Speed Limiter device (ASL)**		■	■	■	■	■	■	■
Front height adjustable seat belts		■	■	■	■	■	■	■
Perimetric alarm with engine immobilization		■	■	■	■	■	■	■

Convenience and Luggage Compartment Features

	OPTION CODE	SE	HSE	HST	SUPERCHARGED	SUPERCHARGED DYNAMIC	AUTOBIOGRAPHY	SVR
CONVENIENCE FEATURES								
Rear Park Distance sensors with visual display		■	■	■	■	■	■	■
Front Parking Aid with front visual display**		■	■	■	■	■	■	■
Cruise control**		■	■	■	■	■	■	■
Adaptive Cruise Control with Queue Assist, intelligent emergency braking** and active seat belts*	065AG	□	□	-	□	□	□	□
Rear view camera**		■	■	■	■	■	-	-
Surround camera system**	086GC	□	□	-	□	□	■	■
Lane Departure Warning with Traffic Sign Recognition** (optional as part of a package)	086DB	□	□	-	□	□	□	□
Park Assist – Parallel Parking / Parking Exit / Perpendicular Parking / 360° Park Distance Control** (optional as part of a package)	086HA	□	□	-	□	□	□	□
Blind spot monitor with closing vehicle sensing and reverse traffic detection** (optional as part of a package)	086GF	□	□	■	□	□	■	■
HomeLink®	025FG	□	■	■	■	■	■	■
Soft door close (optional as part of a package, excluding SVR)	076FC	□	□	-	□	□	■	□
Keyless entry		■	■	■	■	■	■	■
Gesture Tailgate		■	■	■	■	■	■	■

■ Standard □ Optional – Not Available ^Δ No Cost Option

*Please remember that the safety belts in a vehicle constitute the primary protection system for driver and passengers in collisions. Airbags are not designed to deploy in all collisions. The airbag Supplemental Restraint System (SRS) is a supplement to the safety belts and is designed to work as a system with the safety belts. Although airbags provide additional protection, airbags without safety belts do not provide optimal protection in a crash. Always wear your safety belts. Children younger than 13 years old should always be properly restrained in a back seat, away from airbags. Never place an infant seat in the front seat.

**These systems are not a substitute for driving safely with due care and attention and will not function under all circumstances, speeds, weather and road conditions, etc. Driver should not assume that these systems will correct errors of judgment in driving. Please consult the owner's manual or your local authorized Land Rover Retailer for more details.

Visit LandRoverUSA.com for more information.



ABOVE & BEYOND

> FIND A RETAILER

> BUILD YOUR OWN

OVERVIEW

SPECIFICATION

STANDARD AND OPTIONAL FEATURES

Convenience and Luggage Compartment Features continued

	OPTION CODE	SE	HSE	HST	SUPERCHARGED	SUPERCHARGED DYNAMIC	AUTOBIOGRAPHY	SVR
LUGGAGE COMPARTMENT FEATURES								
Roller luggage compartment cover		■	■	■	■	■	■	■
Luggage compartment mounting provisions		■	■	■	■	■	■	■

Information, Communication and Entertainment

	OPTION CODE	SE	HSE	HST	SUPERCHARGED	SUPERCHARGED DYNAMIC	AUTOBIOGRAPHY	SVR
Range Rover Audio System (250W) with eight speakers		■	■	-	■	■	-	-
Meridian™ Surround Sound Audio System (825W) with 19 speakers	025LN	□	□	■	□	□	■	■
Meridian Signature Reference Audio System (1700W) with 23 speakers	025LV	-	□	-	□	□	□	□
SiriusXM® Satellite Radio & HD Radio™ (Includes Sirius Channels only)		■	■	■	■	■	■	■
Eight-inch Touch-screen**		■	■	■	■	■	■	■
User selectable screen savers		■	■	■	■	■	■	■
Partial TFT / LCD instrument cluster		■	■	-	■	-	-	-
TFT virtual instrument panel		-	-	■	-	■	■	■
Hard disk navigation system (includes voice control)**		■	■	■	■	■	■	■
Eight-inch rear seat entertainment with remote control and two sets of wireless headphones (one USB in second row)†	129AH	□	□	-	□	□	□	-
MP3 compatible audio disk		■	■	■	■	■	■	■
One USB Socket in cubby box		■	■	■	■	■	■	■
Auxiliary device connectivity (full integrated streaming)		■	■	■	■	■	■	■
Bluetooth® audio streaming and Bluetooth® phone connection**		■	■	■	■	■	■	■
Auxiliary power sockets (front, second row and luggage compartment 12V)		■	■	■	■	■	■	■
Land Rover InControl® Apps™††		■	■	■	■	■	■	■
Land Rover InControl™ Protect for warranty period		■	■	■	■	■	■	■
Land Rover InControl™ Remote		■	■	■	■	■	■	■
Land Rover InControl WiFi (optional as part of a package)	025RB	□	□	-	□	□	□	□
Head Up Display*	039IB	□	□	-	□	□	□	□

■ Standard □ Optional - Not Available

The Bluetooth® word mark and logos are owned by the Bluetooth SIG, Inc. and any use of such marks by Land Rover is under license.

*These systems are not a substitute for driving safely with due care and attention and will not function under all circumstances, speeds, weather and road conditions, etc. Driver should not assume that these systems will correct errors of judgment in driving. Please consult the owner's manual or your local authorized Land Rover Retailer for more details.

**Driving while distracted can result in loss of vehicle control. Do not operate, adjust or view the navigation or multimedia systems under conditions that will affect your safety or the safety of others. Only use mobile phones, and other devices, even with voice commands, when it is safe to do so.

†Requires: 60:40 folding seats with load through and 825W or 1700W audio system.

††Do not use Land Rover InControl® features under conditions that will affect your safety or the safety of others. Driving while distracted can result in loss of vehicle control.



ABOVE & BEYOND

> FIND A RETAILER

> BUILD YOUR OWN

OVERVIEW

SPECIFICATION

STEP 2
CHOOSE YOUR MODEL

Option Packages

	OPTION CODE	SE	HSE	HST	SUPERCHARGED	SUPERCHARGED DYNAMIC	AUTOBIOGRAPHY	SVR
Climate Comfort and Visibility Package (A) – consists of heated front and rear seats, leather heated steering wheel, heated windshield, Homelink®, auto dimming exterior mirrors, 16-way / 16-way powered seats with memory, 60:40 folding rear seats with load through, auto-dimming power adjustable heated power fold exterior mirrors with approach lamps, blind spot monitor with closing vehicle sensing and reverse traffic detection, front fog lamps, Adaptive Xenon headlamps with High Beam Assist (AHBA)*	075FA	□	-	-	-	-	-	-
Front Climate Comfort and Visibility Package (B) – consists of climate front and heated rear seats, leather heated steering wheel, heated windshield, 16-way / 16-way powered seats with memory, 60:40 folding rear seats with load through, Adaptive Xenon headlamps with High Beam Assist (AHBA)*, auto dimming power adjustable heated power fold exterior mirrors with approach lamps and blind spot monitor with closing vehicle sensing and reverse traffic detection	075FB	-	□	-	□	□	-	-
Luxury Climate Comfort and Visibility Package (C) – consists of climate front seats and climate rear seats, leather heated steering wheel, heated windshield, 16-way / 16-way powered seats with memory, 60:40 folding rear seats with load through, four-zone climate control, auto dimming exterior mirrors, adaptive headlamps with Automatic High Beam Assist (AHBA)*	075FF	-	□	-	□	□	-	-
Vision and Convenience Package (Requires A, B, or C)* – consists of surround camera system*, InControl™ Remote for warranty period (Late availability, please contact your Land Rover Retailer) and soft door close	074MR	□	□	-	□	□	-	-
Climate Comfort Package – consists of four-zone climate control and climate rear seats	072BD	-	-	-	-	-	□	□
Driver Assistance Package (Requires A, B or C) – consists of Lane Departure Warning with Traffic Sign Recognition, Park Assist - Parallel Parking / Parking Exit / Perpendicular Parking / 360° Park Distance Control*	074OK	□	□	-	□	□	□	-
V6 Supercharged HST Package – consists of Meridian™ surround sound audio system (825W) with 19 speakers, climate front seats and heated rear seats, leather heated steering wheel, 60:40 folding rear seats with load through, auto-dimming power adjustable heated power fold exterior mirrors with approach lamps, blind spot monitor with closing vehicle sensing and reverse traffic detection, Adaptive Xenon headlamps with LED signature and High Beam Assist (AHBA)*		-	-	■	-	-	-	-

■ Standard □ Optional – Not Available

Visit LandRoverUSA.com for more information.



ABOVE & BEYOND

> FIND A RETAILER

> BUILD YOUR OWN

OVERVIEW

SPECIFICATION

3

Body and Roof color

Fuji White
(Solid)

Yulong White
(Metallic)

Aleutian Silver*
(Metallic)

Indus Silver
(Metallic)

Kaikoura Stone
(Metallic)

Aruba
(Premium Metallic)

Scotia Grey
(Metallic)

Corris Grey
(Metallic)

Waitomo Grey
(Premium Metallic)

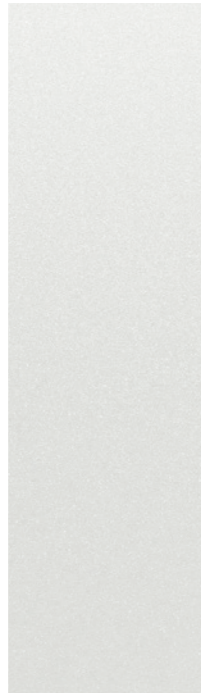

Optional Roof color

Contrast Indus Silver

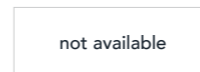
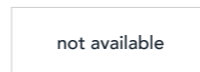
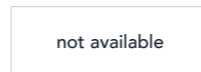
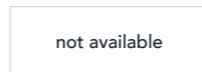
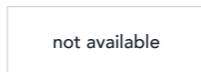
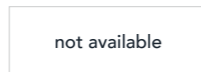

Contrast Corris Grey

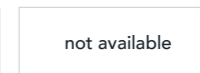
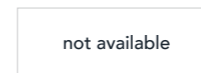
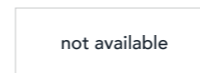

Contrast Santorini Black



*Available until October 2015.





ABOVE & BEYOND

> FIND A RETAILER

> BUILD YOUR OWN

OVERVIEW

SPECIFICATION

Body and Roof color

Carpathian Grey
(Premium Metallic)

Montalcino Red
(Metallic)

Firenze Red
(Metallic)

Aintree Green
(Metallic)

Loire Blue
(Metallic)

Mariana Black
(Premium Metallic)

Santorini Black
(Metallic)

Zanzibar
(Metallic)

Barolo Black
(Premium Metallic)

Estoril Blue**
(Metallic)



Optional Roof color

Contrast Indus Silver



Contrast Corris Grey



Contrast Santorini Black



Visit LandRoverUSA.com for more information.



ABOVE & BEYOND

> FIND A RETAILER

> BUILD YOUR OWN

OVERVIEW

SPECIFICATION

4



19 INCH FIVE SPLIT-SPOKE
'STYLE 501'*



19 INCH FIVE SPLIT-SPOKE
SATIN DARK GREY FINISH
'STYLE 501'*



20 INCH FIVE SPLIT-SPOKE
'STYLE 520'*



21 INCH FIVE SPLIT-SPOKE
'STYLE 505'



21 INCH FIVE SPLIT-SPOKE
'STYLE 507'*

	OPTION CODE	SE	HSE	HST	SUPERCHARGED	SUPERCHARGED DYNAMIC	AUTOBIOGRAPHY	SVR
WHEELS								
19 inch five split-spoke 'Style 501'*	029SA	■	△	-	-	-	-	-
19 inch five split-spoke 'Style 501' with Satin Dark Grey finish*	029XR	□	△	-	-	-	-	-
20 inch five split-spoke 'Style 520'*	029YT	□	■	-	■	△	△	-
21 inch five split-spoke 'Style 505'	-	-	-	-	-	-	■	-
21 inch five split-spoke 'Style 507'*	029YU	□	□	-	□	△	△	-

*Available as an accessory fitment.





ABOVE & BEYOND

> FIND A RETAILER

> BUILD YOUR OWN

OVERVIEW

SPECIFICATION

STEP 4
CHOOSE YOUR WHEELS



21 INCH FIVE SPLIT-SPOKE
DIAMOND TURNED FINISH
'STYLE 507'*



21 INCH FIVE SPLIT-SPOKE
SATIN DARK GREY FINISH
'STYLE 507'



21 INCH FIVE SPLIT-SPOKE
'STYLE 517'



22 INCH FIVE SPLIT-SPOKE
'STYLE 504'



22 INCH 10 SPLIT-SPOKE
'STYLE 108'

	OPTION CODE	SE	HSE	HST	SUPERCHARGED	SUPERCHARGED DYNAMIC	AUTOBIOGRAPHY	SVR
WHEELS								
21 inch five split-spoke 'Style 507' with Diamond Turned finish*	029YV	-	-	-	-	■	□	-
21 inch five split-spoke 'Style 507' with Satin Dark Grey finish		-	-	■	-	-	-	-
21 inch five split-spoke 'Style 517'		-	-	-	-	-	-	■
22 inch five split-spoke 'Style 504'	029SF	□	□	-	□	□	□	-
22 inch 10 split-spoke 'Style 108'	029TU	-	-	-	-	-	-	□

■ Standard □ Optional Δ No Cost Option - Not Available

Visit LandRoverUSA.com for more information.



ABOVE & BEYOND

> FIND A RETAILER

> BUILD YOUR OWN

OVERVIEW

SPECIFICATION

5

CHOOSE YOUR SEAT CONFIGURATION



5 Seats

The seat configuration has been intelligently engineered to accommodate the lines of the roofline. The cabin is light and spacious, ensuring everyone has a relaxed and comfortable journey. There is generous leg, shoulder and head room throughout the contemporary cabin.





ABOVE & BEYOND

> FIND A RETAILER

> BUILD YOUR OWN

OVERVIEW

SPECIFICATION

STEP 5
CHOOSE YOUR INTERIOR



5 + 2 Seating

The 5+2 arrangement has two seats stowed under the floor of the luggage compartment that can be used for occasional use, enabling the vehicle to accommodate up to seven occupants.

The third row seats are suitable for use by older children who can either use the adult belt or a booster seat in conjunction with the adult belt. They are not suitable for smaller children who require a child seat where the adult belt is not used directly to restrain the child.

Visit LandRoverUSA.com for more information.

73

ENGINES

MODELS

COLORS

WHEELS

INTERIORS

ACCESSORIES

TECHNICAL DETAILS



ABOVE & BEYOND

> FIND A RETAILER

> BUILD YOUR OWN

OVERVIEW

SPECIFICATION

CHOOSE YOUR INTERIOR COLOR COMBINATIONS

	(A)	(B)	(C)	(D)	(E)							
COLORWAYS	EBONY/EBONY (page 77)	EBONY/LUNAR (page 77)	ESPRESSO/ALMOND (page 77)	EBONY/CIRRUS (page 78)	ESPRESSO/IVORY (page 78)							
INTERIOR COLOR												
Seat color	Ebony	Lunar	Ebony/ Lunar	Espresso	Almond	Espresso/ Almond	Ebony	Cirrus	Ebony/ Cirrus	Espresso	Ivory	Espresso/ Ivory
Carpet	Ebony	Ebony		Espresso			Ebony				Espresso	
MODEL												
SE (Grained leather)	○	–	–	–	○	–	–	○	–	–	–	–
HSE (Oxford Perforated leather)	○	–	–	○	○	–	○	○	–	○	○	–
HST (Oxford Perforated leather)	○	–	○	–	–	–	–	–	○	–	–	–
Supercharged (Oxford Perforated leather)	○	○	○	○	○	○	○	○	○	○	○	○
Supercharged Dynamic (Oxford Perforated leather)	○	–	–	○	○	–	○	○	–	○	○	–
Autobiography (Oxford Perforated leather with Autobiography Pattern)	○	○	○	○	○	○	○	○	○	○	○	○
SVR (Oxford Perforated leather with SVR Pattern)	○	–	–	–	–	–	–	–	○	–	–	–
INTERIOR FINISHERS												
Dark Brushed Aluminum finisher	○	○	○	○	○	○	○	○	○	○	○	○
Micro Mesh Aluminum finisher	○	○	○	○	○	○	○	○	○	○	○	○
Sport Textured Aluminum finisher	○	○	○	○	○	○	○	○	○	○	○	○
Dark Engine Turned Aluminum finisher	○	○	○	○	○	○	○	○	○	○	○	○
Carbon Fiber Veneer finisher**	–	–	–	–	–	–	–	–	○	–	–	–
Shadow Zebrano Wood Veneer	–	–	–	○	○	○	–	–	–	○	○	○
Dark Grey Oak Wood Veneer	○	○	○	–	–	–	○	○	○	–	–	–
Grand Black Wood Veneer	○	○	○	○	○	○	○	○	○	○	○	○
EXTERIOR COLOR												
Fuji White	○	○	○	○	○	○	○	○	▲	○	○	○
Yulong White	▲	○	▲	○	○	○	▲	▲	▲	○	○	○
Aleutian Silver*	○	○	○	○	○	○	○	▲	○	○	○	○
Indus Silver	○	○	○	○	○	○	▲	○	○	○	○	○
Kaikoura Stone	○	○	○	▲	○	○	○	○	○	▲	○	▲
Aruba	○	○	○	▲	○	○	○	○	○	▲	○	○
Scotia Grey	○	○	○	○	○	○	○	○	○	○	○	○
Corris Grey	○	○	▲	○	○	○	○	○	▲	○	○	○
Waitomo Grey	○	○	○	○	▲	▲	○	○	○	○	▲	▲
Carpathian Grey	○	○	▲	○	○	○	▲	○	▲	○	○	○
Montalcino Red	▲	○	○	○	○	○	○	○	○	○	○	○
Firenze Red	▲	○	○	○	○	○	○	○	○	○	○	○
Aintree Green	○	○	○	○	○	○	○	○	○	○	▲	○
Loire Blue	○	○	○	○	○	○	○	○	○	○	○	○
Mariana Black	○	○	○	○	○	○	○	▲	○	○	○	○
Santorini Black	▲	▲	▲	○	○	○	○	▲	○	○	○	○
Zanzibar	○	○	○	○	○	○	○	○	○	○	○	○
Barolo Black	○	○	○	○	○	○	○	○	○	○	▲	○
Estoril Blue**	▲	–	–	–	–	–	–	–	▲	–	–	–

▲ Combination is Designer's Choice ○ Combination is Available – Not Available *The availability of exterior paint colors varies by model and by time of year. Please contact your local Land Rover Retailer for further details. **Only available on SVR. The above table is designed as a guide. Please contact your nearest Land Rover Retailer for more information.



ABOVE & BEYOND

> FIND A RETAILER

> BUILD YOUR OWN

OVERVIEW

SPECIFICATION

STEP 5
CHOOSE YOUR INTERIOR

	F EBONY/IVORY (page 79)			G EBONY/TAN (page 79)		H EBONY/PIMENTO (page 78)		I ESPRESSO/ IVORY/TAN (page 78)	J EBONY/ LUNAR/CIRRUS (page 79)	K EBONY/LUNAR/ PIMENTO (page 79)
COLORWAYS										
INTERIOR COLOR										
Seat color	Ebony	Ivory	Ebony/Ivory	Tan	Ebony/Tan	Pimento	Ebony/Pimento	Espresso/ Ivory/Tan	Ebony/Lunar/ Cirrus	Ebony/Lunar/ Pimento
Carpet	Ebony			Ebony		Ebony		Espresso	Ebony	Ebony
MODEL										
SE (Grained leather)	o	-	o	-	-	o	-	-	-	-
HSE (Oxford Perforated leather)	o	o	o	-	o	o	-	o	o	-
HST (Oxford Perforated leather)	o	o	o	-	-	-	-	o	o	-
Supercharged (Oxford Perforated leather)	o	o	o	-	o	o	-	o	o	-
Supercharged Dynamic (Oxford Perforated leather)	o	o	o	o	o	o	o	o	o	o
Autobiography (Oxford Perforated leather with Autobiography Pattern)	-	-	-	-	o	-	o	-	-	-
SVR (Oxford Perforated leather with SVR Pattern)	-	-	-	-	o	-	o	-	-	-
INTERIOR FINISHERS										
Dark Brushed Aluminum finisher	o	o	o	o	o	o	o	o	o	o
Micro Mesh Aluminum finisher	o	o	o	o	o	o	o	o	o	o
Sport Textured Aluminum finisher	o	o	o	o	o	o	o	o	o	o
Dark Engine Turned Aluminum finisher	o	o	o	o	o	o	o	o	o	o
Carbon Fiber Veneer finisher**	-	-	-	-	o	-	o	-	-	-
Shadow Zebrano Wood Veneer	-	o	o	o	-	-	-	o	o	o
Dark Grey Oak Wood Veneer	o	-	-	-	o	o	o	-	-	-
Grand Black Wood Veneer	o	o	o	o	o	o	o	o	o	o
EXTERIOR COLOR										
Fuji White	o	o	o	▲	o	o	-	▲	▲	o
Yulong White	o	o	o	▲	▲	▲	-	o	▲	o
Aleutian Silver*	o	o	o	o	o	o	o	o	▲	o
Indus Silver	o	o	o	o	o	o	o	o	o	o
Kaikoura Stone	o	o	o	o	o	o	o	o	o	o
Aruba	o	▲	o	o	o	o	o	▲	o	o
Scotia Grey	o	o	o	o	o	o	o	o	o	o
Corris Grey	o	o	o	▲	o	o	▲	o	▲	▲
Waitomo Grey	o	o	o	o	o	o	o	▲	▲	o
Carpathian Grey	o	o	▲	o	▲	▲	o	o	▲	▲
Montalcino Red	o	o	o	-	-	o	▲	-	o	▲
Firenze Red	▲	o	o	-	-	▲	o	o	o	▲
Aintree Green	o	o	o	o	o	o	o	o	▲	o
Loire Blue	o	▲	o	o	o	o	o	o	o	o
Mariana Black	o	▲	o	o	o	o	o	o	o	o
Santorini Black	o	▲	▲	o	▲	▲	o	o	o	o
Zanzibar	o	o	o	▲	▲	o	o	▲	o	o
Barolo Black	o	o	o	o	o	o	o	o	▲	o
Estoril Blue**	-	-	-	-	o	-	o	-	-	-

Visit LandRoverUSA.com for more information.



ABOVE & BEYOND

> FIND A RETAILER

> BUILD YOUR OWN

OVERVIEW

SPECIFICATION

COLOR CHOICES

Each interior comes in up to three color combinations. You can use this section to place your chosen color theme within the vehicle to personalize your cabin. A choice of trim finishers is also available.



	1	2	3	4	5
COLOR THEMES	DOOR TOP ROLL	DOOR ARMREST	DOOR LOWER	INSTRUMENT PANEL UPPER	INSTRUMENT PANEL MID/CENTER CONSOLE LID
(A) Ebony/Ebony	Ebony	Ebony	Ebony	Ebony	Ebony
(B) Ebony/Lunar	Lunar	Lunar	Ebony	Ebony	Lunar
(C) Espresso/Almond	Almond	Almond	Almond	Espresso	Almond
(D) Ebony/Cirrus	Cirrus	Cirrus	Ebony	Ebony	Cirrus
(E) Espresso/Ivory	Ivory	Ivory	Ivory	Espresso	Ivory
(F) Ebony/Ivory	Ivory	Ivory	Ebony	Ebony	Ivory
(G) Ebony/Tan*	Tan	Tan	Ebony	Ebony	Tan
(H) Ebony/Pimento*	Pimento	Pimento	Ebony	Ebony	Pimento
(I) Espresso/Ivory/Tan	Ivory	Tan	Ivory	Espresso	Ivory
(J) Ebony/Lunar/Cirrus	Lunar	Cirrus	Ebony	Ebony	Lunar
(K) Ebony/Lunar/Pimento	Lunar	Pimento	Ebony	Ebony	Lunar

*On Supercharged Dynamic, the instrument panel mid panel and door top rolls are Ebony unless the Extended Leather Package is selected.



ABOVE & BEYOND

> FIND A RETAILER

> BUILD YOUR OWN

OVERVIEW

SPECIFICATION

STEP 5
CHOOSE YOUR INTERIOR

AVAILABLE INTERIOR COLOR COMBINATIONS

The cabin in Range Rover Sport embodies the finest of contemporary living. The warmth of wood veneers, superb metal finishes and soft leathers combine to create a sense of home. The attention to detail is everywhere you look and in everything you touch. A wide range of color themes and seat materials is available to suit all tastes.

- B Ebony / Lunar** (available on SE, HSE, HST, Supercharged, Supercharged Dynamic, and Autobiography)



Interior shown: Autobiography in Ebony/Lunar with Ebony/Lunar seats and Dark Engine Turned Aluminum finisher.

- A Ebony / Ebony** (available on SE, HSE, HST, Supercharged, Supercharged Dynamic, Autobiography and SVR)



Interior shown: HSE interior in Ebony/Ebony, with Ebony seats and Micro Mesh Aluminum finisher, with optional full TFT instrument panel.

- C Espresso / Almond** (available on SE, HSE, Supercharged, Supercharged Dynamic, and Autobiography)



Interior shown: Autobiography interior in Espresso/Almond, with Espresso/Almond seats and Shadow Zebrano Wood Veneer.

Visit LandRoverUSA.com to configure your vehicle online.

77

ENGINES

MODELS

COLORS

WHEELS

INTERIORS

ACCESSORIES

TECHNICAL DETAILS



ABOVE & BEYOND

> FIND A RETAILER

> BUILD YOUR OWN

OVERVIEW

SPECIFICATION

AVAILABLE INTERIOR COLOR COMBINATIONS

D Ebony / Cirrus (available on SE, HSE, HST, Supercharged, Supercharged Dynamic, Autobiography and SVR)



Interior shown: HSE interior in Ebony/Cirrus, with Ebony seats and Grand Black Wood Veneer, with optional full TFT instrument panel.

E Espresso / Ivory (available on HSE, Supercharged, Supercharged Dynamic and Autobiography)



Interior shown: Autobiography interior in Espresso/Ivory, with Espresso/Ivory seats and Dark Engine Turned Aluminum finisher.

H Ebony / Pimento (available on HST, Supercharged Dynamic, Autobiography and SVR)



Interior shown: Autobiography interior in Ebony/Pimento, with Ebony/Pimento seats and Dark Engine Turned Aluminum finisher.

I Espresso / Ivory / Tan (available on Autobiography only)



Interior shown: Autobiography interior in Espresso/Ivory/Tan, with Espresso/Ivory/Tan seats and Shadow Zebano Wood Veneer.



ABOVE & BEYOND

> FIND A RETAILER

> BUILD YOUR OWN

OVERVIEW

SPECIFICATION

STEP 5
CHOOSE YOUR INTERIOR

F **Ebony / Ivory** (HSE, Supercharged, Supercharged Dynamic and Autobiography)



Interior shown: Autobiography interior in Ebony/Ivory, with Ebony/Ivory seats and Grand Black Wood Veneer.

G **Ebony / Tan** (available on HST, Supercharged Dynamic, Autobiography and SVR)



Interior shown: Autobiography with Dynamic Pack interior in Ebony/Tan, with Ebony/Tan seats and Dark Grey Oak Wood Veneer.

J **Ebony / Lunar / Cirrus** (available on Autobiography only)



Interior shown: Autobiography interior in Ebony/Lunar/Cirrus, with Ebony/Lunar/Cirrus seats and Dark Grey Oak Wood Veneer.

K **Ebony / Lunar / Pimento** (available on Autobiography only)



Interior shown: Autobiography interior in Ebony/Lunar/Pimento, with Ebony/Lunar/Pimento seats and Dark Grey Oak Wood Veneer.

Visit LandRoverUSA.com to configure your vehicle online.



ABOVE & BEYOND

> FIND A RETAILER

> BUILD YOUR OWN

OVERVIEW

SPECIFICATION

INTERIOR FINISHERS

Now you have chosen your interior color combination, choose one of three interior finishers. For full availability and designer's choices, please see the color and trim matrix on pages 74 and 75.

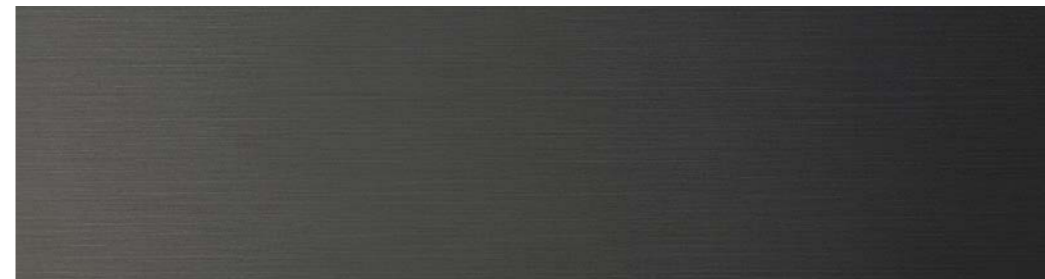

Dark Brushed Aluminum Finisher

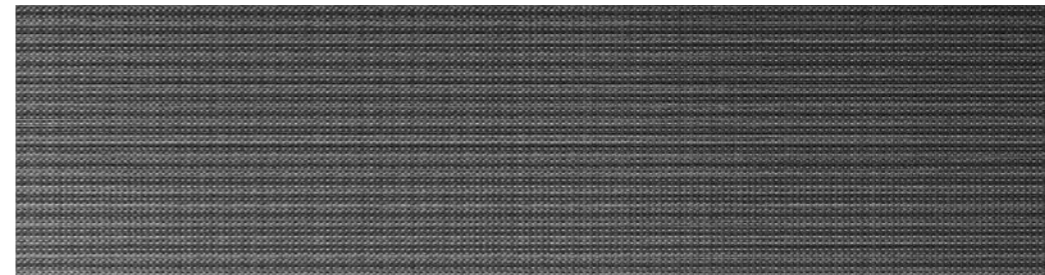

Micro Mesh Aluminum Finisher

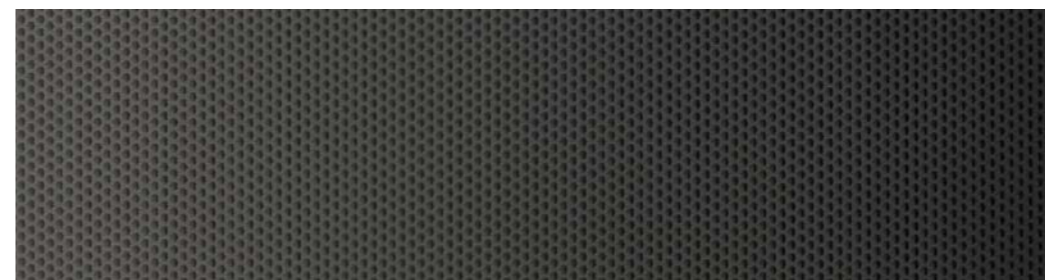

Sport Textured Aluminum Finisher





ABOVE & BEYOND

> FIND A RETAILER

> BUILD YOUR OWN

OVERVIEW

SPECIFICATION

STEP 5
CHOOSE YOUR INTERIOR

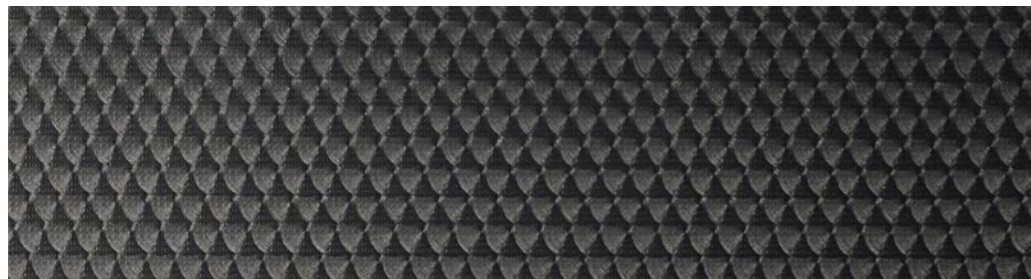

Dark Engine Turned Aluminum Finisher



Dark Grey Oak Wood Veneer



Carbon Fiber Veneer Finisher (SVR only)



Grand Black Wood Veneer



Shadow Zebrano Wood Veneer

Visit LandRoverUSA.com to configure your vehicle online.



ABOVE & BEYOND

> FIND A RETAILER

> BUILD YOUR OWN

OVERVIEW

SPECIFICATION

6





ABOVE & BEYOND

> FIND A RETAILER

> BUILD YOUR OWN

OVERVIEW

SPECIFICATION

STEP 6
CHOOSE YOUR ACCESSORIES

LAND ROVER APPROVED ACCESSORIES



Some owners want to add their own stamp of individuality by tailoring their Range Rover Sport to their specific needs with a range of stylish, practical accessories that are tough, versatile and bring an opportunity for personalization to Range Rover Sport. Importantly, these accessories can be added at any stage during the vehicle's life.

Land Rover Approved Accessories are designed, tested and manufactured to the same exacting standards as the original equipment fitted to your vehicle.

Vehicle shown above is an accessorized HSE with Dynamic Pack in Corris Grey with optional Red Painted brake calipers.
Vehicle shown left is an accessorized Autobiography in Corris Grey with optional Red Painted brake calipers.

Visit LandRoverUSA.com for more information.

83

ENGINES

MODELS

COLORS

WHEELS

INTERIORS

ACCESSORIES

TECHNICAL DETAILS



ABOVE & BEYOND

> FIND A RETAILER

> BUILD YOUR OWN

OVERVIEW

SPECIFICATION



Deployable Side Steps*

These smart, practical steps make it easier to get in and out of the vehicle. Neatly stowed under the sills, the Side Steps automatically deploy as soon as the door is opened, or when activated by the key fob. They stow automatically when the door is closed. Please contact your local Land Rover Retailer for more information.



**Fixed Side Step*
VPLGP0226**

The Fixed Side Steps aid entry and exit to the vehicle and improve access to the roof. Design features include Range Rover branding and bright anodized aluminum edge trim finish to complement vehicle styling cues. Vehicle software update allows compatibility for earlier model year vehicles.



**Side Protection Tubes*
VPLWP0154**

Manufactured from stainless steel with a highly polished finish, this product helps protect the vehicle in off-road conditions. Its rugged off-road appearance complements the vehicle's exterior design.



**Stainless Steel Front Undershield*
VPLWP0162**

The off-road inspired styled undershield features a premium bright polished finish for the front of the vehicle.



**Stainless Steel Rear Undershield*
VPLWP0163**

Stainless Steel Rear Undershield (Towing)
VPLWP0164**



**Body Side Mouldings
VPLWP0159**

Providing protection for your door panels from accidental damage by adjacent vehicles. Painted to match your vehicle's body color, ensuring a premium finish and maintaining the overall aesthetics of your Range Rover Sport.

*Fitting of Side Steps or Side Protection Tubes may affect the off-road capability of the vehicle.
**Can be used with Tow Bar Armature VPLWT0150.
†Not applicable with SVR.



ABOVE & BEYOND

> FIND A RETAILER

> BUILD YOUR OWN

OVERVIEW

SPECIFICATION

STEP 6
CHOOSE YOUR ACCESSORIES



Carbon Fiber Front Grille Surround*
VPLWB0233

A stunning new range of high gloss lacquered finish carbon fiber enhancements, which include: Hood louvers, fender vents and tailgate finisher. Together they add an even more performance-inspired effect to your Range Rover Sport.



Carbon Fiber Hood Louvers
VPLWB0231



Carbon Fiber Fog Lamp Bezel*
VPLWB0234



Carbon Fiber Side Vent Blades*
VPLWB0232



Carbon Fiber Mirror Covers
VPLWB0230



Carbon Fiber Tailgate Trim
VPLWB0235

Visit LandRoverUSA.com for more information.



ABOVE & BEYOND

> FIND A RETAILER

> BUILD YOUR OWN

OVERVIEW

SPECIFICATION



20 inch five split-spoke 'Style 520' with Gloss Black Finish
VPLWW0090*



21 inch five split-spoke 'Style 507' with Gloss Black Finish
VPLWW0091*



21 inch forged nine-spoke 'Style 705' with Full Machine Polished Finish
VPLWW0083*



21 inch forged nine-spoke 'Style 705' with Low Gloss Finish
VPLWW0084*



21 inch forged nine-spoke 'Style 705' with Satin Black Finish
VPLWW0085*



22 inch forged five split-spoke 'Style 514' with Machine Polished Finish
VPLWW0086*†

*Rim only. Center caps available separately.
†Not available with 5+2 Seating.



ABOVE & BEYOND

> FIND A RETAILER

> BUILD YOUR OWN

OVERVIEW

SPECIFICATION

STEP 6
CHOOSE YOUR ACCESSORIES



22 inch five split-spoke 'Style 514' ceramic polished with Light Silver Finish
VPLWW0088*†



22 inch five split-spoke 'Style 514' fully painted with Technical Grey Gloss Finish
VPLWW0087*†



22 inch five split-spoke 'Style 514' fully painted with Low Gloss Black Finish
VPLWW0089*†

Visit LandRoverUSA.com for more information.

87

ENGINES

MODELS

COLORS

WHEELS

INTERIORS

ACCESSORIES

TECHNICAL DETAILS



ABOVE & BEYOND

> FIND A RETAILER

> BUILD YOUR OWN

OVERVIEW

SPECIFICATION



Stainless Steel Sports Pedals
VPLGS0160
Stainless Steel pedals feature a bright design and hidden fixings for a clean finish.



Premium carpet mats
LR041635 – Ebony
LR041634 – Espresso
72.3oz weight deep pile carpet mats with waterproof backing.



Rubber floor mats
VPLWS0190
Rubber footwell mats for front and second row occupants help provide protection from general dirt.



Illuminated Treadplates
VPLWS0208
Illuminated treadplates are available on both the driver and front passenger sides of the vehicle to welcome you into the cabin.



Personalized Illuminated Treadplates
VPLWS0212 – Front
VPLWS0209 – Vehicle Set
You can personalize your vehicle further by adding a script of your choice in a variety of fonts which will be highlighted by subtle white illumination. Available as a full vehicle set (front pair personalized, rear pair illuminated only) or as a front pair only.



Door Sill Outer Treadplate
VPLWS0207
An aluminum enhancement for the outer door sills featuring a laser etched 'Sport' motif.



ABOVE & BEYOND

> FIND A RETAILER

> BUILD YOUR OWN

OVERVIEW

SPECIFICATION

STEP 6
CHOOSE YOUR ACCESSORIES



Luggage Divider – Full Height
VPLWS0235

The Luggage Divider is designed to prevent cargo from entering the passenger compartment. It incorporates a useful integral ski hatch that allows longer items to be carried where a suitable rear seat option is fitted.

Luggage Divider – Half Height
VPLWS0236

Luggage Divider – Luggage Compartment Partition
VPLWS0237



Illuminated Rear Luggage Compartment Treadplate Finisher
VPLWS0211PVJ – Ebony
VPLWS0211AAM – Espresso

Manufactured from stainless steel with a bright finish, protecting the luggage compartment trim when loading or unloading. Providing a premium finish to the luggage compartment with subtle illumination.



Rear Luggage Compartment Treadplate Finisher
VPLWS0210PVJ – Ebony
VPLWS0210AAM – Espresso

Manufactured from stainless steel with a bright finish, protecting the luggage compartment trim when loading or unloading.



Luggage Compartment Stowage Rails
VPLWS0242 – 5 Seat
VPLWS0243 – 5+2 Seating

Loadspace mounted rails to facilitate flexible stowage solutions. Luggage compartment Stowage Rails allow fitment of the Luggage Retention Kit.

Luggage Compartment Retention Kit
VPLGS0171

Pack of attachments that fix into the luggage compartment rails via a quick lock/quick release system to provide a flexible solution for retaining items. The attachment pack includes a retractable strap with inertia reel, telescopic rod and stowage bag.



Luggage Compartment Mat – Rubber
VPLWS0225

Range Rover branded rubber mat helps to protect the rear luggage compartment carpet from general dirt. Rubber mat extension for protection of the back of the rear seats when folded down also available – Part No: VPLWS0223



Luggage Compartment Liner Tray
VPLWS0224

This liner provides superior protection to the luggage compartment floor and side wall carpets from dirty or wet equipment.

Visit LandRoverUSA.com for more information.



ABOVE & BEYOND

> FIND A RETAILER

> BUILD YOUR OWN

OVERVIEW

SPECIFICATION



Roof Rails*
VPLWR0104 – Black Finish†
VPLWR0103 – Silver Finish††

Roof Rails facilitate easy fitment of cross bars. Pre-set positioning points ensure cross bars are fixed in optimum position for weight distribution and dynamics.

Cross Bars*
VPLGR0102
T-track design utilizes the full length of the bars, providing space to mount multiple accessories. Aerodynamic profile minimizes drag and noise. Roof rails not included.

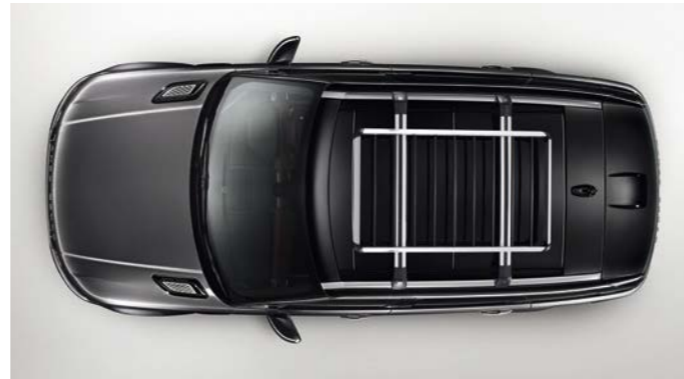

Luggage Carrier*
LR006848
Flexible rack system to facilitate roof carrying. Maximum payload 165lbs.**

Roof Mounted Bike Carrier (not shown)*
VPLFR0091
Roof Mounted Bike Carrier – Fork Mounted with Wheel Carrier (not shown)*
VPLWR0101

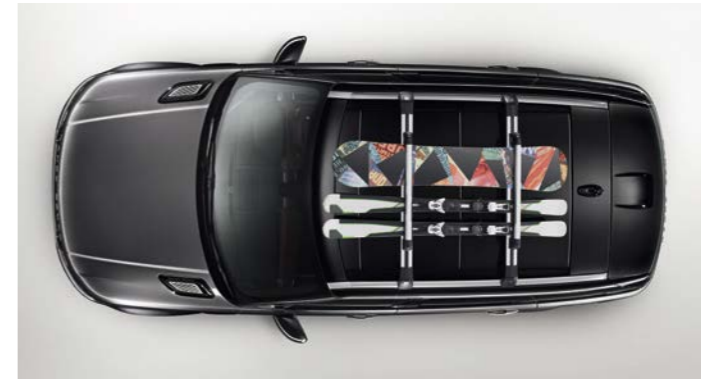

Ski/Snowboard Holder* – LR006849
Carries four pairs of skis or two snowboards. Lockable for security. Maximum payload 79lbs.**

Aqua Sports Carrier (not shown) – VPLGR0107
Carries one surfboard, sailboard, canoe or kayak. Includes lockable multi-purpose holder to carry a mast, oars or paddles. Tilts to facilitate easy loading/unloading. Maximum payload 99.2lbs.**

Maximum load capacity is 220lbs and incremental height when fitted is 3.5 inches.

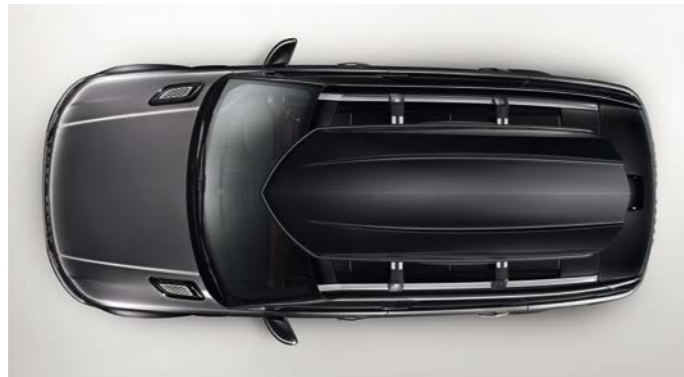

Large Sports Roof Box*
VPLWR0100
Featuring a quick mounting system for easy secure fixation. Includes integrated base mat with a non-slip surface for extra secure loading. Capable of carrying up to four pairs of skis or five snowboards. Volume 430 liters. Maximum payload 165lbs.**



Luggage Box*
VPLVR0062
The gloss black finish Luggage Box opens from both sides and includes power-grip mounting for easy and quick fixing to the roof bars. Lockable for security. Volume 410 liters. Maximum payload 165lbs.**

*Roof Rails and Cross Bars are required for all Land Rover roof mounted accessories. Objects placed above the roof mounted satellite antenna may reduce the quality of the signal received by the vehicle and could have a detrimental effect on the navigation and satellite radio system, if fitted. Vehicles with an opening roof: Some roof carrying accessories may restrict opening of the vehicle's sliding sunroof when fitted. Care should be taken when opening the roof to avoid collision with any items fitted above the vehicle.
**Maximum payload equals the load capacity of the roof mounted accessory. †Roof Rail Ditch Finishers required for fitment with Black Finish Roof Rails – VPLWR0108.
††Roof Rail Ditch Finishers required for fitment with Silver Finish Roof Rails – VPLWR0109.



ABOVE & BEYOND

> FIND A RETAILER

> BUILD YOUR OWN

OVERVIEW

SPECIFICATION

STEP 6
CHOOSE YOUR ACCESSORIES



Outdoor Car Cover
VPLWC0061

All weather tailored cover protects your Range Rover Sport from the elements.



Windshield Sun Shield
VPLWS0231

Helps to keep the vehicle interior cool in hot weather.



Noble Plated Mirror Caps
VPLGB0073

Noble Plated Mirror Caps complement the Range Rover Sport's exterior styling cues.



Tow Bar Receiver
VPLWT0150

This bespoke system has been optimized alongside the Range Rover advanced aluminum chassis construction. Approved for up to 7,716lb trailer load.

Trailer Hitch Kit (VPLWY0083) and Towing Electrics Kit are available separately.

- Dark Atlas Bumper Fitting Kit – VPLWB0136
- Light Atlas Bumper Fitting Kit – VPLWB0139
- Gloss Black Bumper Fitting Kit – VPLWB0137

*Towing load capacity on SVR is 6,614lbs.
**Not available with Fixed Side Step.



Towing Electrics
VPLWT0115

These handy sockets are mounted conveniently in your vehicle's rear bumper, providing the electrical power needed for rear lighting on your trailer. Must be used with Trailer Hitch Kit.



Front Mudflaps
VPLWP0165

SVR Front Mudflaps **
VPLWP0222

Front Mudflaps for Deployable
Side Steps (not shown)
VPLWP0167

Rear Mudflaps
VPLWP0166

SVR Rear Mudflaps
VPLWP0221

Mudflaps reduce spray and help protect the paintwork. Supplied as a pair.

Visit LandRoverUSA.com for more information.



ABOVE & BEYOND

> FIND A RETAILER

> BUILD YOUR OWN

OVERVIEW

SPECIFICATION

DIMENSIONS AND CAPABILITIES



Wheelbase 115.1 inches

Overall length 191 inches



Turning Circle

Curb-to-curb 39.7 feet
Wall-to-wall 41.0 feet
Turns lock-to-lock 2.78



Height 70.1 inches



Front wheel track 66.5 inches



Rear wheel track 66.3 inches

Width 81.6 inches mirrors folded
Width 87.4 inches mirrors out



Ground Clearance

Off-road height 10.9 inches
Standard ride height 8.4 inches

Standard Ride Height

With roof rails 70.1 inches
With roof antenna 71.0 inches
With panoramic roof open 71.54 inches
Access height air suspension setting will reduce each of the above by 1.97 inches

Luggage Compartment Capacity

Second Row seats upright
Height 30.2 inches, Width 50.6 inches
Luggage compartment volume 27.7 cu.ft
Luggage compartment width between arches 44.1 inches
Length at floor 41.1 inches - 45.0 inches

Second Row Seats Folded Forward
Height 30.2 inches, Width 50.6 inches
Luggage compartment volume 62.2 cu.ft
Luggage compartment width between arches 42.2 inches
Length at floor 73.7 inches

Headroom

Maximum front headroom with panoramic roof 39.4 inches
Rear headroom 39.1 inches

Wading depth*

Maximum wading depth 33.5 inches

Please note: Figures may vary for SVR



	A	B	C
Ride Height			
Off-road (SVR)	33.0° (30.0°)	27.2° (27.0°)	31.0° (27.3°)
Standard (SVR)	24.3° (22.4°)	19.4° (19.4°)	24.9° (22.5°)



*These systems are not a substitute for driving safely with due care and attention and will not function under all circumstances, speeds, weather and road conditions, etc. Driver should not assume that these systems will correct errors of judgment in driving. Please consult the owner's manual or your local authorized Land Rover Retailer for more details.



ABOVE & BEYOND

> FIND A RETAILER

> BUILD YOUR OWN

OVERVIEW

SPECIFICATION

TECHNICAL DETAILS

TECHNICAL SPECIFICATION, PERFORMANCE AND KEY DATA

	DIESEL	GASOLINE			
	3.0L V6 TD6 TURBOCHARGED	3.0L V6 SUPERCHARGED	3.0L V6 SUPERCHARGED	5.0L V8 SUPERCHARGED	5.0L V8 SUPERCHARGED SVR
	AUTOMATIC	AUTOMATIC	AUTOMATIC	AUTOMATIC	AUTOMATIC
POWER (HP)	254*	340*	380*	510*	550*
ENGINE DATA					
Capacity (cc)	2,993	2,995	2,995	5,000	5,000
No. of cylinders	6	6	6	8	8
Cylinder layout	Longitudinal 60 Degree V6	Longitudinal 90 Degree V6	Longitudinal 90 Degree V6	Longitudinal 90 Degree V8	Longitudinal 90 Degree V8
Valves per cylinder	4	4	4	4	4
Bore (inches)	3.31	3.33	3.33	3.64	3.64
Stroke (inches)	3.54	3.5	3.5	3.66	3.66
Compression ratio (:1)	16.1	10.5	10.5	9.5	9.5
Maximum power HP / rpm	254 / 4,000	340 / 6,500	380 / 6,500	510 / 6,000 – 6,500	550 / 6,000 – 6,500
Maximum torque (lb-ft / rpm)	440 / 2,000	332 / 3,500 – 5,000	332 / 3,500 – 5,000	461 / 2,500 – 5,500	502 / 3,500 – 4,000
BRAKES					
Front type	Ventilated disc	Ventilated disc	Ventilated disc	Ventilated disc	Ventilated disc
Front diameter (inches)	13.78	13.78	14.96	14.96	14.96
Rear type	Ventilated disc	Ventilated disc	Ventilated disc	Ventilated disc	Ventilated disc
Rear diameter (inches)	13.78	13.78	14.37	14.37	14.37
Park Brake	Electric Park Brake (EPB) integrated into brake caliper	Electric Park Brake (EPB) integrated into brake caliper			
WEIGHTS (LBS)					
Weight from	4,709	4,661	4,661	5,186	5,143
Maximum laden weight (5 seat / 5+2 Seating)	6,614 / 6,945	6,504	6,614 / 6,900	6,834 / 7,000	6,614
Maximum mass on each axle (front)	3,307	3,307	3,307	3,307	3,307
Maximum mass on each axle (rear) (5 seat / 5+2 Seating)	3,913 / 4,189	3,913 / 4,189	3,913 / 4,189	3,913 / 4,189	3,913
TOWING (LBS)					
Unbraked trailer	1,653	1,653	1,653	1,653	1,653
Maximum towing	7,716	7,716	7,716	7,716	6,614
Maximum vehicle and trailer combination / Gross Train Weight (5 seat / 5+2 Seating)	14,330 / 14,661	14,330 / 14,617	14,330 / 14,617	14,550 / 14,771	13,228
ROOF CARRYING (LBS)					
Maximum roof load (including roof rails)	220	220	220	220	220
PERFORMANCE AND FUEL ECONOMY					
Maximum speed (mph)**	130	130	130	140 (155*)	162
Acceleration (secs) 0-60mph**	7.1	6.9	6.8	5	4.5
Fuel tank capacity – usable liters / US gallons	89 / 23.5	105 / 27.7	105 / 27.7	105 / 27.7	105 / 27.7
Diesel Particulate Filter (DPF)	■	-	-	-	-

■ Standard – Not Available

*Horsepower figure is Manufacturer's estimate **Always follow local speed limits.

Visit LandRoverUSA.com for more information.



ABOVE & BEYOND

> FIND A RETAILER

> BUILD YOUR OWN

OVERVIEW

SPECIFICATION

LAND ROVER EXPERIENCE

Ever since its inception, Land Rover has been ready for anything. Its legendary capability has seen it tackle the most demanding of terrains, in the most difficult conditions. Its versatile interior has become synonymous with comfort and greater loadspace. And its 'can do' attitude has made it the most welcome of vehicles across the globe.

You can be part of the Land Rover story at one of our Land Rover Experience centers. You can see how each and every one of these iconic vehicles is built. You can take one out onto off-road tracks where your driving skills will be put to the test. Or you can go even further on one of our Adventure Travel holidays to such countries as Tanzania, Iceland or Morocco.

Adventure awaits.



BEHIND THE SCENES TOURS

Ever wanted to discover how your Land Rover was built? To see the incredible journey upon which each and every one of our vehicles travels before you receive it?

You can experience how it is created using advanced technologies, the most efficient processes, the finest materials and British Craftsmanship at our facilities around the world.

From on-demand ordering of parts, to final trim and quality tests, the entire process will come to life before your eyes. It's a truly impressive display of engineering, craft and precision; one that you can then physically enjoy by taking a vehicle out onto one of our Experience Drives.

For more information, visit landrover.com/behindthescenestours





ABOVE & BEYOND

> FIND A RETAILER

> BUILD YOUR OWN

OVERVIEW

SPECIFICATION



EXPERIENCE DRIVES

Wading through mud. Crossing a Tipping Bridge. Or creeping up a slippery, steep incline. Our Experience centers have an array of obstacles and challenges to tax even the most accomplished of drivers.

Our experts will teach you how to navigate through some of the most demanding terrain. Then, you can take the skills that you have learned and use them when you drive every day.

There's a choice of courses from Taster Drives through to Full Day Experiences, available in over 40 Land Rover Experience operations around the globe. Each one provides a unique and hugely memorable adventure that you, your family and friends can all enjoy.

You'll never feel more confident behind the wheel.

To book, go to landrover.com/experiencedrives

ADVENTURE TRAVEL

Which destination would top your wish list of places to go on an adventure? The wide open, savagely beautiful plains of the Serengeti? Or simply exploring castles and manors around Britain? Well, you can revel in an epic adventure from the comfort and luxury of a Land Rover, assured in the meticulous planning and local insight for which Abercrombie & Kent is renowned. These two great British brands have come together to bring you a world of exploration, adventure and luxury in iconic worldwide destinations.

Each trip has a local guide and expert Land Rover instructors to provide support and guidance, ensuring you get the most out of your driving experience. Added to which, you will stay in boutique accommodation. Be part of an extraordinary journey, reimagined.

For more information, visit landrover.com/adventuretravel





ABOVE & BEYOND

> FIND A RETAILER

> BUILD YOUR OWN

OVERVIEW

SPECIFICATION





ABOVE & BEYOND

> FIND A RETAILER

> BUILD YOUR OWN

OVERVIEW

SPECIFICATION



IMPORTANT NOTICE: The colors reproduced here are subject to the limitations of the printing process and may therefore vary slightly from the actual vehicle. The company reserves the right to alter or withdraw any color finish without notice. Certain specifications are built to customer special order.

For delivery availability information, please consult your Land Rover Retailer. Some of these colors may not be obtainable in your country. Please check availability with your Land Rover Retailer. This publication is for international usage and while Land Rover takes the utmost care in ensuring that all the details in the publication are correct at time of printing, we are constantly striving for improvements, and therefore reserve the right to alter specifications and equipment without notice. Details of specifications and equipment are also subject to change to suit local market conditions and requirements, and not all products are available in every market. Some vehicles may be shown with accessories or optional equipment fitted.

These products vary from market to market. Please consult your Land Rover Retailer who will be pleased to advise you on current specifications. Retailers are not agents of Land Rover and have absolutely no authority to bind Land Rover to any express or implied undertaking or representation.

Castrol EDGE Professional recommended by Land Rover.

Vehicle shown left is HSE in Mariana Black.

Jaguar Land Rover North America, LLC

555 MacArthur Blvd.

Mahwah, NJ 07430. 1-800-FIND-4WD

LandRoverUSA.com

© Jaguar Land Rover Limited 2015. Publication Number: LRML 4903/15





ABOVE & BEYOND

> FIND A RETAILER

> BUILD YOUR OWN

OVERVIEW

SPECIFICATION

