

RANGE ROVER



ABOVE AND BEYOND



RANGE ROVER 2014

Range Rover attains exemplary levels of refinement and composure in even the most demanding of conditions. For 2014, Land Rover is proud to introduce two new members into the family: the SDV6 Hybrid, the world's first Diesel Hybrid SUV with full off-road capability and the Long Wheelbase, which is every part a Range Rover, with additional levels of rear seating comfort and every bit a Land Rover at heart.



OXFORD

Page 2



LOS ANGELES

Page 10



ROME

Page 20

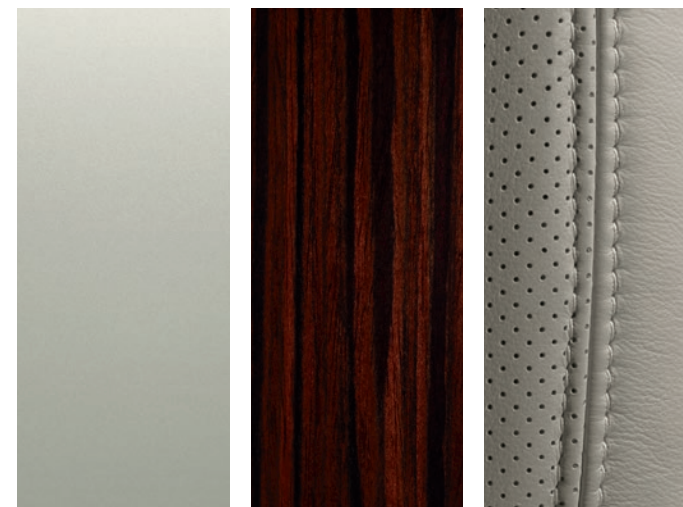

SPECIFICATIONS

Page 26





With its three classic lines of the lower accent graphic, roofline and continuous waistline, the Range Rover is unmistakable. The iconic silhouette is gently tapered and curved, while the use of near-flush glazing and gloss black pillars accentuates the floating roof enhancing its streamlined and elegant form.





With an all-aluminium body and true Land Rover capability at its heart, the Range Rover delivers incredible off-road performance with a greater wading depth, raised air intake and class-leading departure angles. The Range Rover Hybrid* is 100% Land Rover and 100% Hybrid. It delivers outstanding performance no matter what the terrain or conditions.

*Please contact your local Land Rover Dealer regarding SDV6 Hybrid engine availability.



A sure-footed, composed drive is enhanced by the latest four-corner air suspension which provides exceptional wheel articulation and poise. The Auto setting on Terrain Response® 2, the next generation Terrain Response system from Land Rover, automatically optimises vehicle settings to suit any terrain.





The split tailgate is distinctly Range Rover. Its electronically operated upper and lower tailgates help provide a platform for social and sporting events coupled with greater protection from the elements.







Refinement is inherent in the Range Rover. Its interior gives a sense of calm and luxurious comfort. It is beautifully appointed and thoughtfully designed; the broad centre console puts essential controls within easy reach while clean surfaces and the use of soft supple leather, wood veneers and highly polished finishers help create contemporary, comfortable surroundings.



Flooding the interior with light, the panoramic roof enhances the feeling of space and a connection to the world outside. Yet, at the touch of a button, the driver and passengers can feel cocooned once more as the full-length power blind glides into place.

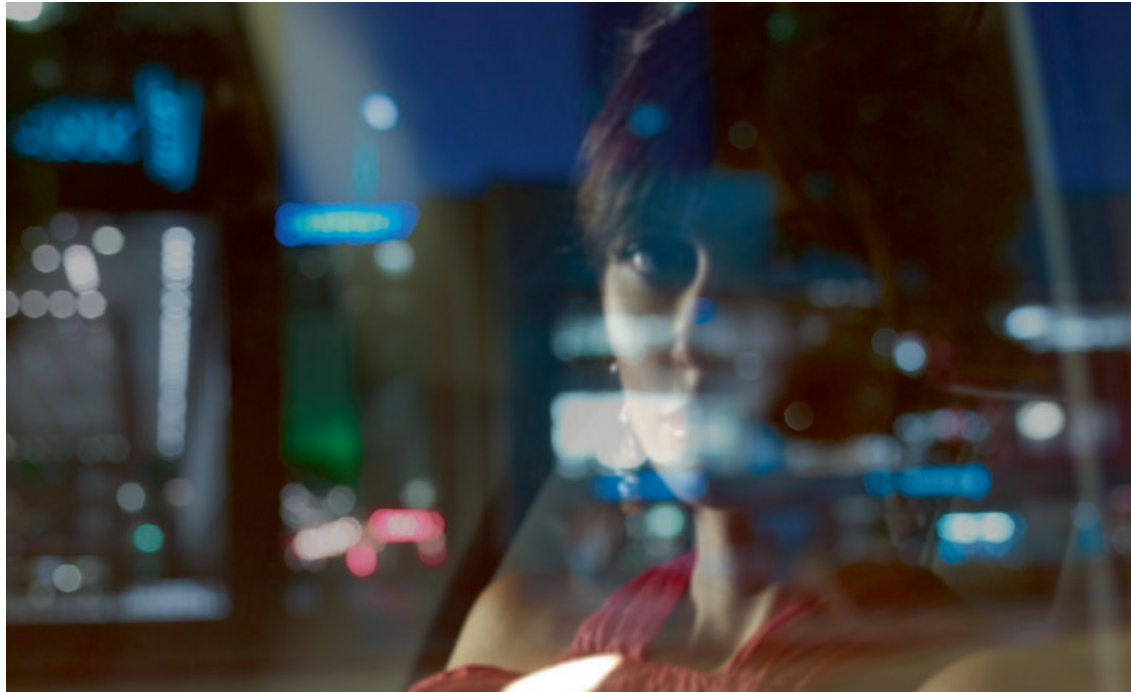

For pure indulgence and refinement in an SUV, nothing comes close. Whether passengers relax or work in the Rear Executive Class seats (available as an option), they will undoubtedly enjoy their individual leather seating with massage function and sweeping centre console.







The exceptional quality of the Meridian™ sound system brings a concert hall experience into the Range Rover. Twenty-nine speakers ensure you hear every note while mood lighting creates the right ambience. There is a palette of ten colours to choose from and simply operated variable brightness controls can cater for every mood.









The overall sense of unparalleled comfort is realised in the Range Rover Long Wheelbase. It is a new and welcome addition to the Range Rover family, providing an extra 186mm in the second row and affording rear passengers an extended recline.



To drive the Range Rover is to experience effortless elegance. From the most demanding and inhospitable terrains to negotiating rush hour city traffic, it delivers a relaxed, intuitive and rewarding drive.







Range Rover's drive is confident and assured with the legendary Command Driving Position giving the driver the best possible view of the road ahead. Dynamic Response and Adaptive Dynamics are available to regulate the front and rear suspension units and vary the dampers to deliver optimum ride, control and composure. When you're in a Range Rover, the miles seem to fly by.

SPECIFICATION

Range Rover offers an exclusive range of options that allow you to personalise your vehicle. The following pages take you through a logical series of steps to bring your individuality to life.

You can start with our online configurator at landrover.com

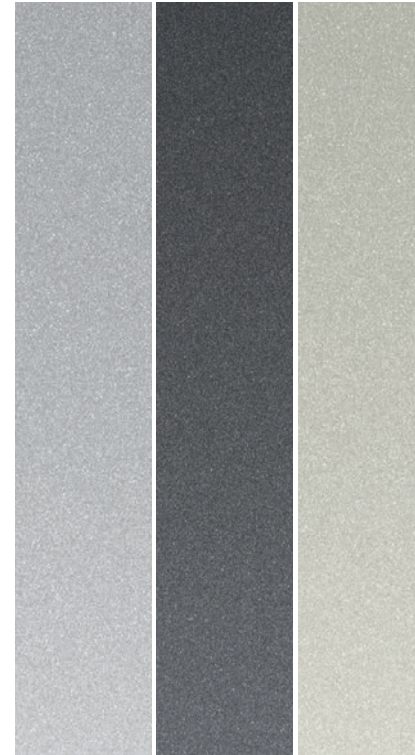
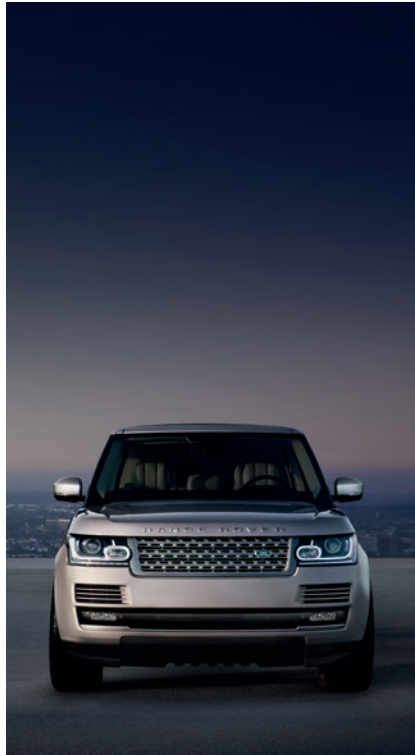

Hybrid

Page 28

The world's first Diesel Hybrid SUV.

Step 1

Choose your engine

Page 32

You can select from an improved and powerful range of petrol, diesel or hybrid engines.

Step 2

Choose your model

Page 34

Compare the standard features on each model. Now with the additional choice of Standard or Long Wheelbase versions.

Step 3

Choose your colour

Page 38

There's a wide range on offer to enable you to express yourself.

Step 4

Choose your wheels

Page 42

There's a range of styles, each one designed to complement the bold exterior.



Step 5

Choose your interior

Page 44

Carefully selected colours complemented by wood veneers. You can personalise your own interior space.

Key Features

Page 62

The latest innovations that make your drive special.

Technical Details

Page 66

All you need to know about dimensions, performance specifications and key data.

Accessories

Page 68

Additional accessories can enhance your personal requirements.

RANGE ROVER HYBRID

New for 2014, Range Rover Hybrid* is the first diesel SUV of its kind in the world. It has been designed and engineered to deliver class-leading capability and versatility. By fully integrating the hybrid technologies into the chassis, nothing has been lost in ground clearance, approach and departure angles or the 900mm wading depth. The vehicle truly is 100% Hybrid, 100% Land Rover.

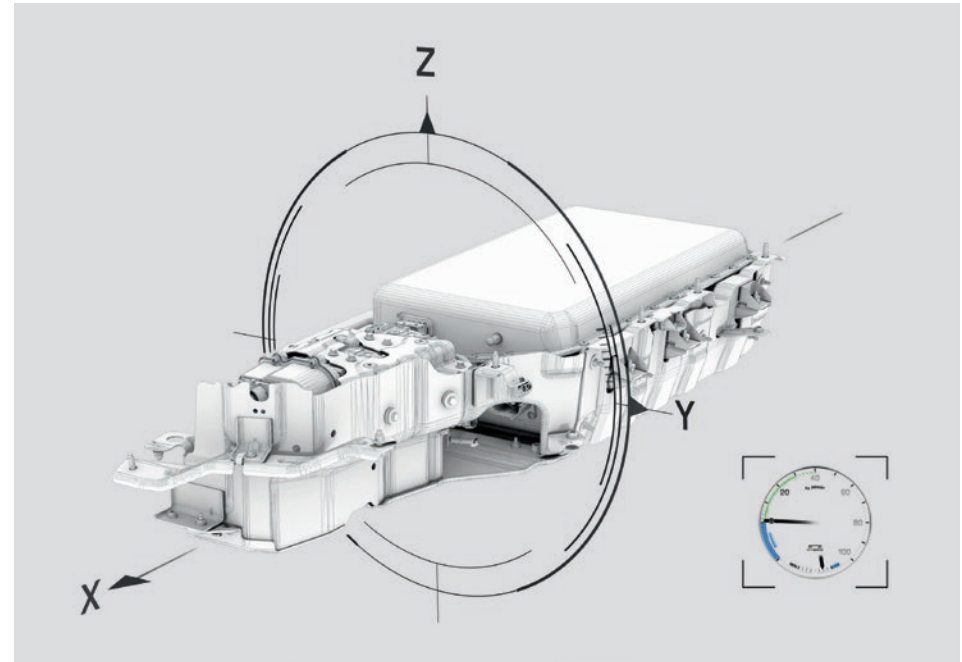

Range Rover Hybrid has been tested on the most demanding terrains, rigs and under the same extremes as every Land Rover. Hybrid technologies deliver impressive efficiencies. The 3.0L SDV6 Diesel engine with a 35kW electric motor generates the same performance as the SDV8 Diesel but with 14% lower (27g/km less) CO₂ emissions when compared to the TDV6 engine at 169g/km.

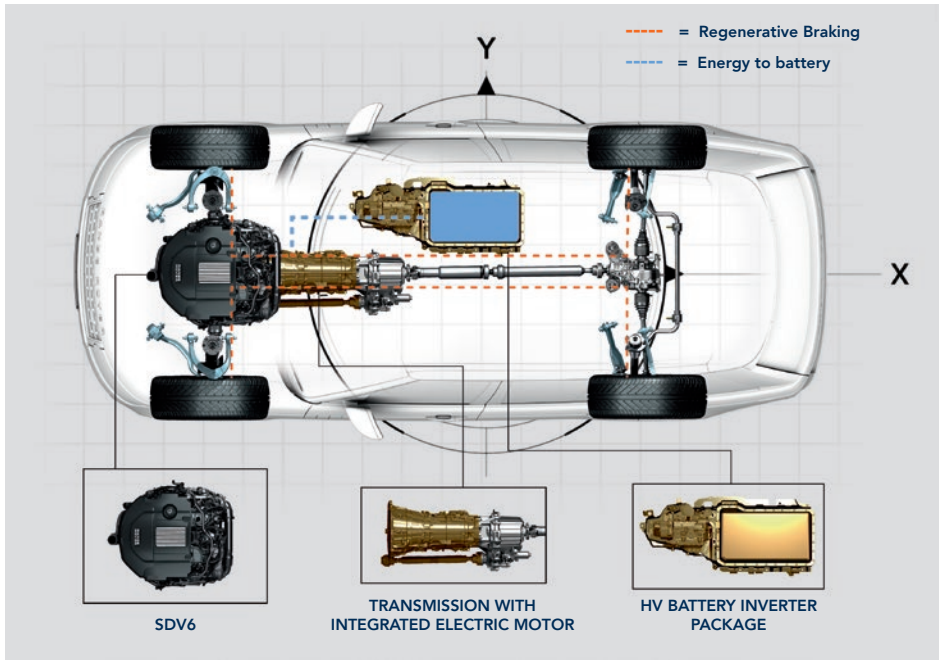

Innovative engineering ensures the transmission of energy between battery and engine is seamless. This energy is created by the Regenerative Braking process, which captures and stores kinetic energy in the battery, normally lost through braking. This is then used to power the electric motor and ensures that torque is instantly available on demand.

RANGE ROVER HYBRID

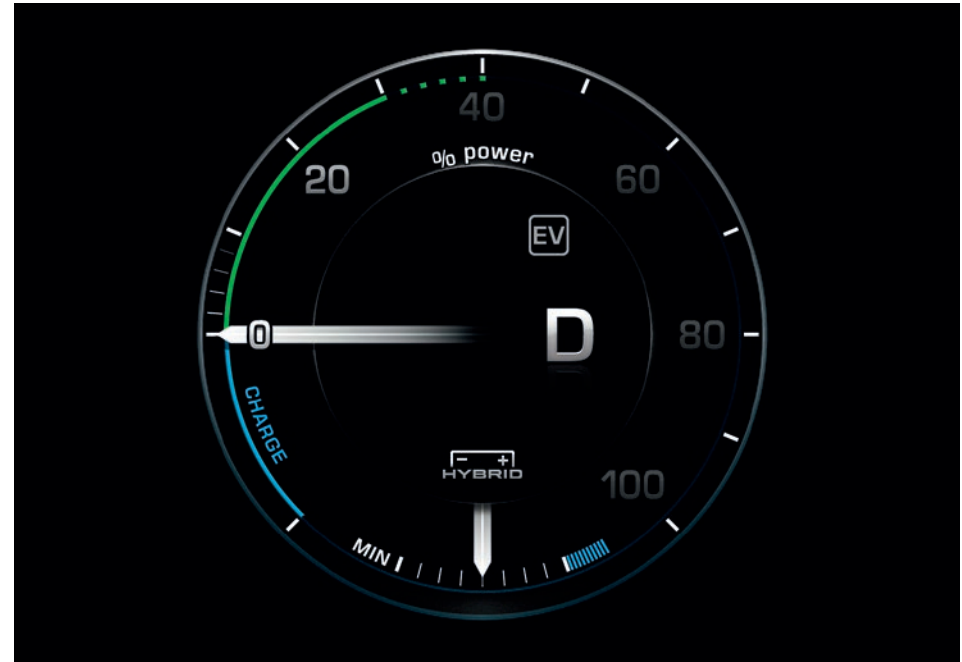

Select from four Hybrid driving modes to tailor the vehicle's performance to your requirements.

- EV** EV On Mode: Optimises hybrid battery power and is whisper quiet enhancing the refinement around town or peaceful villages.
- EV** EV Off Mode: Enables the vehicle's default setting where the hybrid system selects the most efficient combination of diesel and electric power to meet the power and torque required.
- S** Sport Mode: Gives full access to the vehicle's performance, comparable to the SDV8. The throttle response becomes more immediate with torque triggered from less pedal pressure, ideal for when additional power is required.
- A** Auto Stop/Start: Increases charging opportunities as this option means the engine runs continuously, inhibiting the Stop/Start system.



21 INCH SIX-SPOKE
'STYLE 10'

21 INCH SIX-SPOKE
'STYLE 11'
DIAMOND TURNED FINISH



Attention to detail is at the very heart of Land Rover. That's why even the alloy wheels on Range Rover Hybrid have been designed for increased efficiency. The design features spokes that are aerodynamically shaped so, as they move through the air, they require less power to keep them moving.

To finish, the vehicle is specified with a unique Hybrid badge that is located on the side vent.

STEP 1 CHOOSE YOUR ENGINE



DRIVELINE, ENGINE PERFORMANCE AND FUEL ECONOMY

The high performing range of petrol and diesel engines, along with the new hybrid engine, use the latest powertrain technology.

The intelligent Stop/Start[†] system on certain engines automatically shuts down the engine as soon as the vehicle comes to rest. The engine automatically starts again as soon as you lift your foot from the brake.

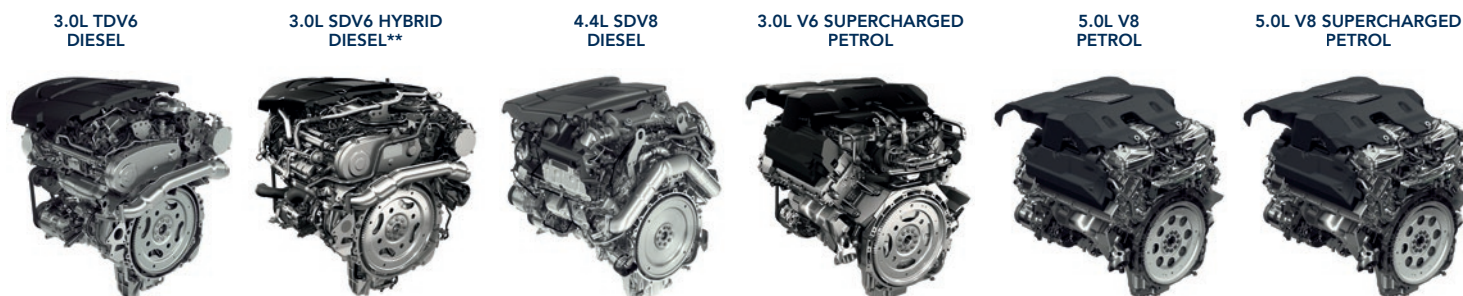

		3.0L TDV6 DIESEL	3.0L SDV6 HYBRID DIESEL	4.4L SDV8 DIESEL	3.0L V6 SUPERCHARGED PETROL	5.0L V8 PETROL	5.0L V8 SUPERCHARGED PETROL
Driveline		Four Wheel Drive (4WD)	Four Wheel Drive (4WD)	Four Wheel Drive (4WD)	Four Wheel Drive (4WD)	Four Wheel Drive (4WD)	Four Wheel Drive (4WD)
Power (kW / PS)		190 / 258	250 / 340	250 / 339	250 / 340	276 / 375	375 / 510
Torque (Nm)		600	700*	700	450	510	625
Maximum torque (rpm)		2,000	1,500-3,000*	1,750-3,000	3,500-5,000	3,500	2,500-5,500
Capacity (cc)		2,993	2,993	4,367	2,995	5,000	5,000
No. of cylinders		6	6	8	6	8	8
Cylinder layout		Longitudinal V6	Longitudinal V6	Longitudinal V8	Longitudinal V6	Longitudinal V8	Longitudinal V8
FUEL ECONOMY							
Urban	l/100km (mpg)	8.5 (33.2) / 10.8 (26.2) [†]	6.7 (42.0)	11.5 (24.6)	14.3 (19.8) / 15.6 (18.1) [†]	18.0 (15.7)	18.3 (15.4) / 20.6 (13.7) [†]
Extra Urban	l/100km (mpg)	7.0 (40.4) / 7.5 (37.7) [†]	6.3 (45.0)	7.6 (37.2)	8.9 (31.7) / 9.1 (31.0) [†]	9.5 (29.7)	9.7 (29.1) / 9.9 (28.5) [†]
Combined	l/100km (mpg)	7.5 (37.7) / 8.6 (32.9) [†]	6.4 (44.1)	8.7 (32.5)	10.9 (25.9) / 11.5 (24.6) [†]	12.8 (22.1)	12.8 (22.1) / 13.8 (20.5) [†]
CO ₂ Urban emissions	g/km	224 / 285 [†]	177	306	333 / 364 ^{**†}	430	426 / 482 ^{**†}
CO ₂ Extra Urban emissions	g/km	187 / 200 [†]	165	203	208 / 212 ^{**†}	226	226 / 232 ^{**†}
CO ₂ Combined emissions	g/km	196 / 227 [†]	169	229	254 / 268 ^{**†}	299	299 / 322 ^{**†}

Please consult your Land Rover Dealer for further details. The figures provided are as a result of official manufacturer's tests in accordance with EU legislation. A vehicle's actual fuel consumption may differ from that achieved in such tests and these figures are for comparative purposes only. Low fuel warning at 9 litres approximately.

*When combined with electric motor

**Not available in all markets

[†]Without Intelligent Stop / Start technology.

Visit landrover.com for more information.

STEP 2 CHOOSE YOUR MODEL



MODELS BY ENGINE AND WHEELBASE

	HSE	VOGUE	VOGUE SE	AUTOBIOGRAPHY
ENGINE				
LR-TDV6 Diesel	■	■	■	■
LR-SDV6 Hybrid Diesel			■	■
LR-SDV8 Diesel		■	■	■
LR-V6 Supercharged Petrol	■	■	■	■
LR-V8 Petrol	■	■	■	■
LR-V8 Supercharged Petrol		■	■	■
WHEELBASE				
Standard Wheelbase	■	■	■	■
Long Wheelbase		■	■	■

STEP 2 CHOOSE YOUR MODEL – CHOICES

Each model has a choice of engines and unique features. This guide will help you to select your ideal Range Rover. On the following pages you'll see the standard features for each model.

HSE



- Grille in Dark Atlas
- Body coloured Vent Blades and door handles
- Front bumper accents in Atlas
- Seats in Grained Leather as standard
- Available on Standard Wheelbase.

VOGUE



- Grille surround in Dark Atlas, Grille Mesh and Ribs in Atlas
- Body coloured Vent Blades and door handles
- Front bumper accents in Atlas
- Seats in Oxford Leather as standard
- Santorini Black mirror caps on Long Wheelbase option
- Available on Standard and Long Wheelbase.

VOGUE SE



- Grille surround in Dark Atlas, Grille Mesh and Ribs in Atlas
- Vent Blades and front bumper accents in Atlas
- Noble plated upper and lower door handles
- Seats in Semi-Aniline Leather with contrast stitching as standard
- Santorini Black Mirror Caps on Long Wheelbase option
- Available on Standard and Long Wheelbase.

AUTOBIOGRAPHY



- Grille surround in Dark Atlas, Mesh in Atlas and Ribs in Bright Chrome
- Vent Blades and front bumper accents in Atlas
- Noble plated upper and lower door handles
- Seats in Semi-Aniline Leather with contrast stitching as standard
- Santorini Black Mirror Caps on Long Wheelbase option
- Autobiography badge on rear tailgate
- Autobiography lettering on tread plates
- Autobiography embossed script on centre rear squab
- Leather Headlining and steering wheel
- Noble plated gear paddles
- Available on Standard and Long Wheelbase.

STEP 3 CHOOSE YOUR COLOUR

Body and Roof Colour

Fuji White (Solid)	Aleutian Silver (Metallic)	Indus Silver (Metallic)	Luxor (Premium Metallic)	Scotia Grey (Metallic)	Corris Grey (Metallic)	Nara Bronze (Metallic)	Causeway Grey (Premium Metallic)
							

Optional Roof Colour

Contrast Indus Silver*

not available	not available	not available					
---------------	---------------	---------------	--	---	---	---	---

Contrast Santorini Black

							
---	---	---	--	---	---	---	---

Body and Roof Colour

Firenze Red
(Metallic)

Aintree Green
(Metallic)

Loire Blue
(Metallic)

Mariana Black
(Premium Metallic)

Santorini Black
(Metallic)

Barossa
(Premium Metallic)

Havana
(Premium Metallic)

Barolo Black
(Premium Metallic)

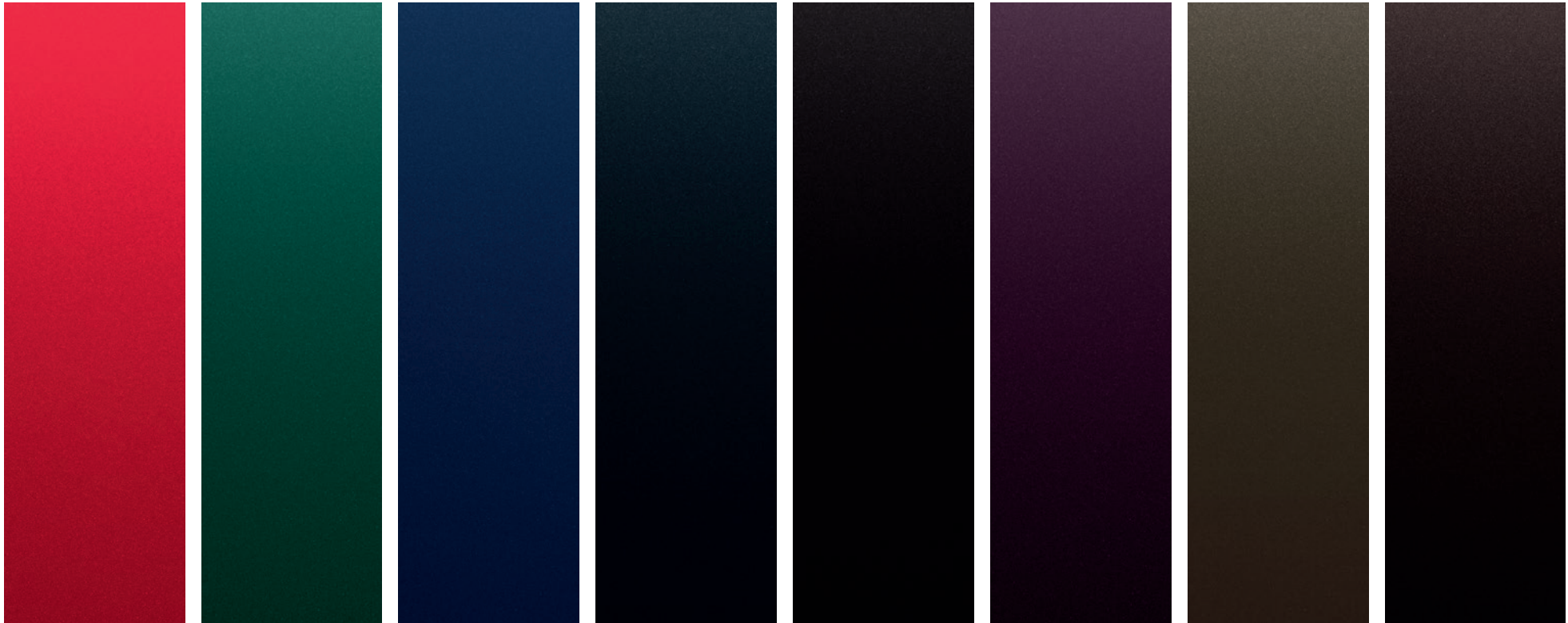

Optional Roof Colour

Contrast Indus Silver*



Contrast Santorini Black



*Not available with Dark Atlas Exterior Accent Packs

Visit landrover.com for more information.

STEP 3 CHOOSE YOUR COLOUR – EXTERIOR ACCENT PACKS

Personalising the exterior

There is plenty of opportunity to tailor the exterior to suit your personal taste. In addition to the standard finish you can change the finish of the side vent graphic to Atlas or choose the Dark Atlas finish as part of an Exterior Accent Packs. These are also available as an accessory fitment. The Black Design Pack gives the overall design of the vehicle a more assertive appearance by changing individual elements to gloss black.

For more information contact your nearest Land Rover Dealership. Or use our online vehicle configurator at landrover.com

STANDARD FINISH (BASED ON VOGUE MODEL)*



- Grille surround in Dark Atlas, Grille Mesh and Ribs in Atlas
- Body coloured Vent Blades and door handles
- Front bumper accents in Atlas
- Lower accent graphic in Atlas.

ATLAS SIDE VENT GRAPHIC**†



- Grille surround in Dark Atlas, Grille Mesh and Ribs in Atlas
- Body coloured Vent Blades and door handles
- Front bumper accents in Atlas
- Lower accent graphic in Atlas
- Side vent graphic in Atlas.

*Model shown with optional 22 inch five split-spoke 'Style 6' alloy wheels.

**There are restrictions on exterior paint and roof colours with certain accent packs.

†Contrast roof in Indus Silver not available.

DARK ATLAS EXTERIOR ACCENT PACKS†



- Grille surround in Dark Atlas, Grille Mesh and Ribs in Atlas
- Body coloured door handles
- Lower accent graphic in Dark Atlas
- Dark Atlas Vent Blades, front and rear bumper accents
- Optional Dark Atlas side vent graphic.

BLACK DESIGN PACK***



- Grille surround, Mesh and Ribs in Santorini Gloss Black
- Vent blades and front bumper finish in Santorini Gloss Black
- Lower accent graphic in Santorini Gloss Black
- Side vent graphic in Santorini Gloss Black
- Santorini Gloss Black upper mirror caps
- Tailgate finisher in Santorini Gloss Black
- Choice of two Black finish wheels – 21 inch and 22 inch, including black wheel nuts
- Range Rover Script on bonnet and tailgate in Santorini Gloss Black.

STEP 4 CHOOSE YOUR WHEELS



19 INCH FIVE SPLIT-SPOKE
'STYLE 1'



20 INCH FIVE SPLIT-SPOKE
'STYLE 2'



20 INCH FIVE SPLIT-SPOKE
SHADOW CHROME FINISH
'STYLE 3'



21 INCH TEN-SPOKE
'STYLE 4'



21 INCH TEN-SPOKE
DIAMOND TURNED FINISH
'STYLE 5'



22 INCH FIVE SPLIT-SPOKE
'STYLE 6'



22 INCH SEVEN SPLIT-SPOKE
DIAMOND TURNED FINISH
'STYLE 7'



22 INCH SEVEN-SPOKE
'STYLE 8'



22 INCH SIX-SPOKE
DIAMOND TURNED FINISH
'STYLE 9'



21 INCH SIX-SPOKE
'STYLE 10'



21 INCH SIX-SPOKE
DIAMOND TURNED FINISH
'STYLE 11'



21 INCH NINE-SPOKE BLACK FINISH
'STYLE 15'



22 INCH SEVEN SPLIT-SPOKE
BLACK FINISH
'STYLE 16'

*Only available with Hybrid models
**Only available with Black Design Pack.

Visit landrover.com for more information.

STEP 5 CHOOSE YOUR INTERIOR





The Range Rover defines modern living. The strong architectural lines of the interior are balanced by soft lighting and the extensive choice of colourways available. The fit and finish, including the judicious use of leather and wood, truly complements the luxurious styling.

STEP 5 CHOOSE YOUR INTERIOR – LEATHER FINISHES



Beautiful materials, flawless execution

The interior is upholstered in the finest natural materials including lavish wood veneers, immaculate metal finishes and premium leathers. Beautifully soft, and with tailored hand-stitching, the type of leather is determined by model choice. It enhances the cabin, covering virtually every surface from the seats and instrument panel to the doors and headlining. The Range Rover Autobiography features Semi-Aniline leather with high-grade hides hand-picked for their exceptional suppleness and natural appearance.

STEP 5 CHOOSE YOUR INTERIOR – TRIM FINISHER CHOICES



SHADOW WALNUT
WOOD VENEER



FIGURED MACASSAR
WOOD VENEER

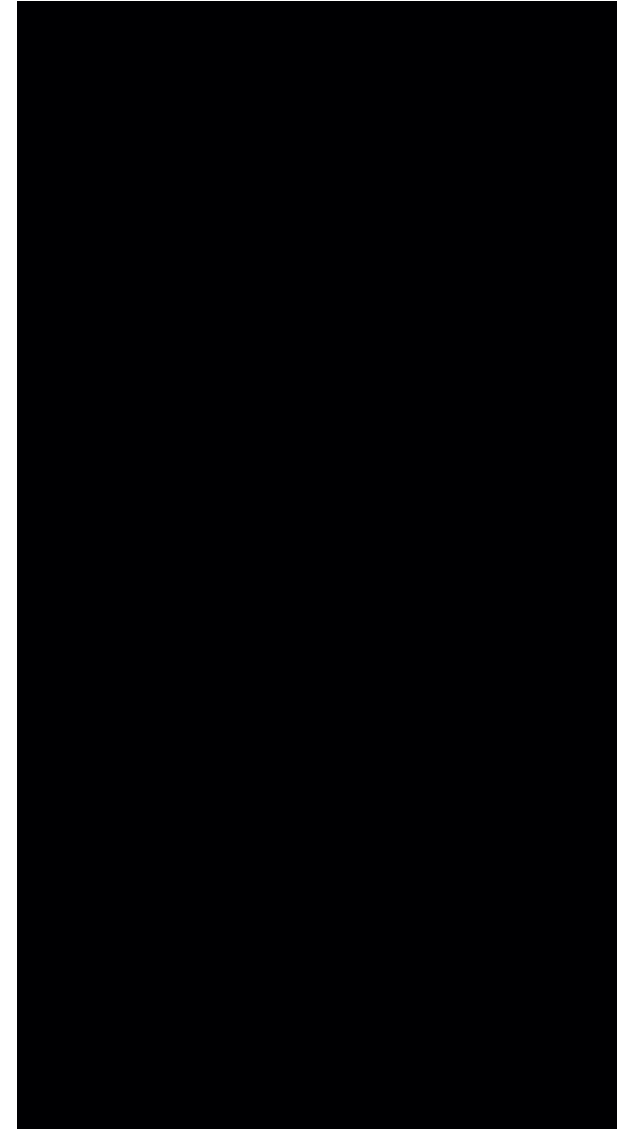

GRAND BLACK
WOOD VENEER

STEP 5 CHOOSE YOUR INTERIOR – INTERIOR SEAT OPTIONS



Bench seat

Standard on all models, the leather bench seat can accommodate up to three passengers and is available with manual or power recline.

The centre seat folds flat to reveal the rear seat cupholders.

For extended load capacity all of the rear seats will fold flat. Additionally this can be operated electronically by the touch of a button in the loadspace for seats specified with power recline.

Available on Standard Wheelbase and Long Wheelbase models.



Rear Executive Class seats



















For the ultimate in rear seat luxury, the Rear Executive Class seating option provides supreme comfort and convenience, with two individual rear seats and the full extended centre console finished in the finest veneer. Seat functionality includes memory, power recline and a three-mode massage feature.

The option of a Long Wheelbase adds 186mm in the second row of seats and has the additional benefit of providing rear passengers with a recline of some 17 degrees.

Note however, these seats do not fold.

Available on Vogue SE and Autobiography Models. Also available on both Standard Wheelbase and Long Wheelbase models.

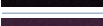
STEP 5 CHOOSE YOUR INTERIOR - COLOUR AND TRIM MATRIX

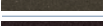
COLOURWAYS		EBONY/ EBONY (page 52)	ESPRESSO/ ALMOND (page 53)	EBONY/ CIRRUS (page 54)	ESPRESSO/ IVORY (page 55)	EBONY/ IVORY (page 56)	NAVY/ CIRRUS (page 57)	EBONY/ TAN (page 58)	BROGUE/ IVORY (page 59)	DARK CHERRY/ IVORY (page 60)	EBONY/ PIMENTO (page 61)
INTERIOR COLOUR											
Seat Colour		Ebony	Almond Espresso	Cirrus Ebony	Ivory Espresso	Ivory Ebony	Cirrus Navy	Tan	Ivory Brogue	Ivory Dark Cherry	Pimento
Carpet		Ebony	Almond	Ebony	Espresso	Ebony	Navy	Ebony	Espresso	Dark Cherry	Ebony
MODEL											
HSE (Grained Leather)		○	○ –	○ –	– –	– –	– –	–	–	–	–
Vogue (Oxford Leather)		○	○ ○	○ ○	○ ○	○ ○	– –	–	–	–	–
Vogue SE (Semi-Aniline Leather)		○	○ ○	○ ○	○ ○	○ ○	○ ○	–	–	–	–
Autobiography (Semi-Aniline Leather)		○	○ ○	○ ○	○ ○	○ ○	○ ○	○	○ ○	○ ○	○
WOOD VENEER											
 Grand Black		○	– –	▲ ▲	– –	○ ○	– –	▲	– –	○ ○	▲
 Figured Macassar		○	▲ ▲	○ ○	▲ ▲	○ ○	○ ○	▲	▲ ▲	▲ ▲	○
 Shadow Walnut		○	○ ○	○ ○	▲ ▲	○ ○	○ ○	○	▲ ▲	○ ○	○
EXTERIOR COLOUR											
 Fuji White		○	○ ○	○ ○	○ ○	○ ○	○ ▲	▲	○ ○	○ ○	○
 Aleutian Silver		○	○ ○	▲ ○	○ ○	○ ○	▲ ▲	○	○ ○	○ ○	○
 Indus Silver		▲	○ ○	▲ ○	○ ○	○ ○	○ ▲	○	○ ○	○ ○	○
 Luxor		○	○ ○	○ ▲	○ ○	▲ ○	○ ○	○	○ ▲	▲ ○	○
 Scotia Grey		○	○ ○	○ ○	○ ○	○ ○	○ ○	○	○ ○	○ ○	○
 Corris Grey		▲	○ ○	▲ ○	○ ○	○ ○	○ ○	○	○ ○	○ ○	▲
 Nara Bronze		○	○ ▲	○ ○	○ ▲	○ ○	○ ○	○	○ ▲	○ ○	○
 Causeway Grey		▲	○ ○	▲ ○	○ ○	▲ ○	○ ○	▲	○ ○	○ ○	○
 Firenze Red		○	○ ○	○ ○	○ ○	○ ▲	○ ○	–	○ ○	○ ○	▲
 Aintree Green		○	○ ○	○ ○	▲ ○	○ ○	– –	○	○ ○	– –	○
 Loire Blue		○	○ ○	○ ○	○ ○	▲ ○	○ ▲	○	○ ○	○ ○	○
 Mariana Black		○	○ ○	○ ○	○ ○	▲ ○	▲ ▲	○	○ ○	○ ○	○
 Santorini Black		○	○ ○	▲ ○	○ ○	○ ▲	○ ○	▲	○ ○	○ ○	▲
 Barossa		○	○ ○	○ ○	○ ○	○ ○	○ ○	○	○ ○	▲ ▲	○
 Havana		○	▲ ○	○ ○	▲ ○	○ ○	○ ○	○	○ ○	○ ○	○
 Barolo Black		○	○ ○	○ ○	▲ ○	○ ○	○ ○	▲	○ ○	○ ○	○

▲ Combination is Designer's Choice ○ Combination is Available – Not Available.

STEP 5 CHOOSE YOUR INTERIOR – CHOICES

Interior colour choices

Each interior comes in a combination of two colours – the primary colour and a complementary secondary colour. You can further personalise your interior colour selections with a choice of wood veneers. If you choose the Vogue, Vogue SE or Autobiography models you can also specify the colour of your seat*.



COLOURWAYS	① INSTRUMENT PANEL UPPER	② INSTRUMENT PANEL LOWER	③ DOOR AND ARMREST UPPER	④ DOOR LOWER	⑤ CUBBY BOX**
Ebony/Ebony	Ebony	Ebony	Ebony	Ebony	Ebony
Espresso/Almond	Espresso	Almond	Almond	Espresso	Espresso/Almond
Ebony/Cirrus	Ebony	Cirrus	Cirrus	Ebony	Ebony/Cirrus
Espresso/Ivory	Espresso	Ivory	Ivory	Espresso	Espresso/Ivory
Ebony/Ivory	Ebony	Ivory	Ivory	Ebony	Ebony/Ivory
Navy/Cirrus	Navy	Cirrus	Cirrus	Navy	Navy/Cirrus
Ebony/Tan	Ebony	Tan	Tan	Ebony	Tan
Brogue/Ivory	Brogue	Ivory	Ivory	Brogue	Brogue/Ivory
Dark Cherry/Ivory	Dark Cherry	Ivory	Ivory	Dark Cherry	Dark Cherry/Ivory
Ebony/Pimento	Ebony	Pimento	Pimento	Ebony	Pimento

*Not available on all colourways. Please refer to page 50 for specific colourway options.

**Cubby Box colour matches seat colour chosen.

STEP 5 CHOOSE YOUR INTERIOR – CHOICES

Ebony / Ebony (available on HSE, Vogue, Vogue SE and Autobiography models)



Interior shown:
Ebony/Ebony, with Ebony seats
and Grand Black Wood Veneer.

Seat



Ebony

Wood Veneer



Grand Black Wood Veneer



Figured Macassar Wood Veneer



Shadow Walnut Wood Veneer

This interior is available in Grained leather on HSE models, Oxford leather on Vogue models and Semi-Aniline leather on Vogue SE and Autobiography models. For specific colourway options please refer to page 50.

Espresso / Almond (available on HSE, Vogue, Vogue SE and Autobiography models)

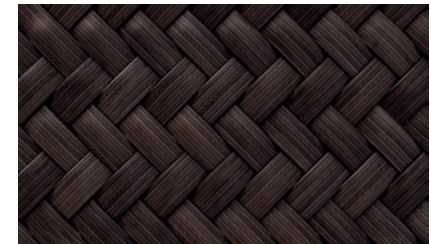

Interior shown:
Espresso/Almond, with Almond
seats and Shadow Walnut
Wood Veneer.

Seat



Almond

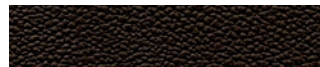

Espresso*

Wood Veneer



Shadow Walnut Wood Veneer



Figured Macassar Wood Veneer

This interior is available in Grained leather on HSE models, Oxford leather on Vogue models and Semi-Aniline leather on Vogue SE and Autobiography models. For specific colourway options please refer to page 50.

*Not available on HSE.

STEP 5 CHOOSE YOUR INTERIOR – CHOICES

Ebony / Cirrus (available on HSE, Vogue, Vogue SE and Autobiography models)



Interior shown:
Ebony/Cirrus, with Cirrus seats
and Grand Black Wood Veneer.

Seat



Cirrus



Ebony*

Wood Veneer



Grand Black Wood Veneer



Figured Macassar Wood Veneer



Shadow Walnut Wood Veneer

This interior is available in Grained leather on HSE models, Oxford leather on Vogue models and Semi-Aniline leather on Vogue SE and Autobiography models. For specific colourway options please refer to page 50.

Headlining is available in Ebony or Cirrus.

Espresso / Ivory (available on Vogue, Vogue SE and Autobiography models)



Interior shown:
Espresso/Ivory, with Espresso
seats and Figured Macassar
Wood Veneer.

Seat

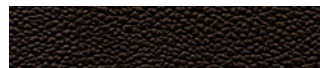

Espresso



Ivory

Wood Veneer



Figured Macassar Wood Veneer

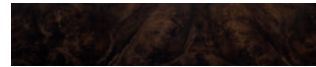

Shadow Walnut Wood Veneer

This interior is available in Oxford leather on Vogue models and Semi-Aniline leather on Vogue SE and Autobiography models. For specific colourway options please refer to page 50.

STEP 5 CHOOSE YOUR INTERIOR – CHOICES

Ebony / Ivory (available on Vogue, Vogue SE and Autobiography models)



Interior shown:
Ebony/Ivory, with Ivory seats
and Grand Black Wood Veneer.

Seat



Ivory



Ebony

Wood Veneer



Grand Black Wood Veneer



Figured Macassar Wood Veneer



Shadow Walnut Wood Veneer

This interior is available in Oxford leather on Vogue models and Semi-Aniline leather on Vogue SE and Autobiography models. For specific colourway options please refer to page 50.

Headlining is available in Ebony or Ivory.

Navy / Cirrus (available on Vogue SE and Autobiography models)

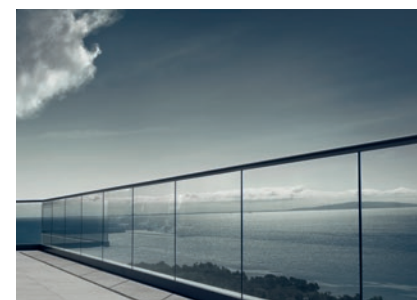

Interior shown:
Navy/Cirrus, with Navy seats
and Shadow Walnut Wood Veneer.

Seat



Navy



Cirrus

Wood Veneer



Shadow Walnut Wood Veneer



Figured Macassar Wood Veneer

This interior is available in Semi-Aniline leather on Vogue SE and Autobiography models. For specific colourway options please refer to page 50.

STEP 5 CHOOSE YOUR INTERIOR – CHOICES

Ebony / Tan (available on Autobiography models)



Interior shown:
Ebony/Tan, with Tan seats
and Figured Macassar
Wood Veneer.

Seat



Tan

Wood Veneer



Figured Macassar Wood Veneer



Grand Black Wood Veneer



Shadow Walnut Wood Veneer

This interior is available as part of the Extended Interior Trim Palette in Semi-Aniline leather on Autobiography. For specific colourway options please refer to page 50.

Headlining is available in Ebony or Ivory.

Brogue / Ivory (available on Autobiography models)



Interior shown:
Brogue/Ivory, with Brogue
seats and Figured Macassar
Wood Veneer.

Seat



Brogue



Ivory

Wood Veneer



Figured Macassar Wood Veneer



Shadow Walnut Wood Veneer

This interior is available as part of the Extended Interior Trim Palette in Semi-Aniline leather on Autobiography. For specific colourway options please refer to page 50.

STEP 5 CHOOSE YOUR INTERIOR – CHOICES

Dark Cherry / Ivory (available on Autobiography models)



Interior shown:
Dark Cherry/Ivory, with Ivory
seats and Figured Macassar
Wood Veneer.

Seat



Ivory

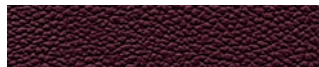

Dark Cherry

Wood Veneer



Figured Macassar Wood Veneer



Grand Black Wood Veneer



Shadow Walnut Wood Veneer

This interior is available as part of the Extended Interior Trim Palette in Semi-Aniline leather on Autobiography. For specific colourway options please refer to page 50.

Ebony / Pimento (available on Autobiography models)

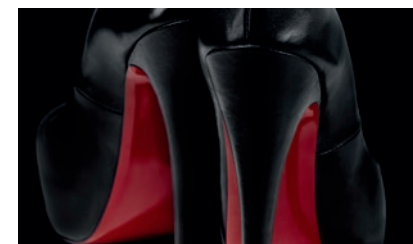
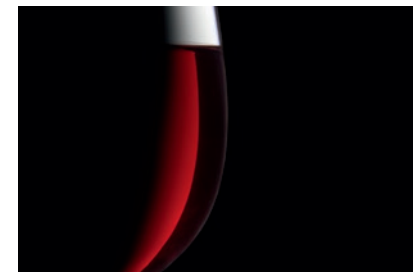

Interior shown:
Ebony/Pimento, with Pimento seats
and Grand Black Wood Veneer.

Seat



Pimento

Wood Veneer



Grand Black Wood Veneer



Figured Macassar Wood Veneer



Shadow Walnut Wood Veneer

This interior is available as part of the Extended Interior Trim Palette in Semi-Aniline leather on Autobiography. For specific colourway options please refer to page 50.

Headlining is available in Ebony or Ivory.

KEY FEATURES



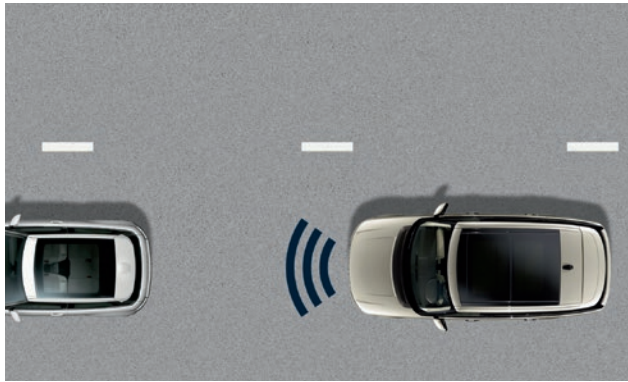

Adaptive Cruise Control with Queue Assist*

Adaptive Cruise Control (ACC) is a system that helps maintain a pre-set gap from the vehicle in front, even if it changes speed.

Queue Assist extends the ACC functionality. It is designed to allow the vehicle to come to a stop when it reaches a traffic queue.

*Queue Assist not available with Hybrid.

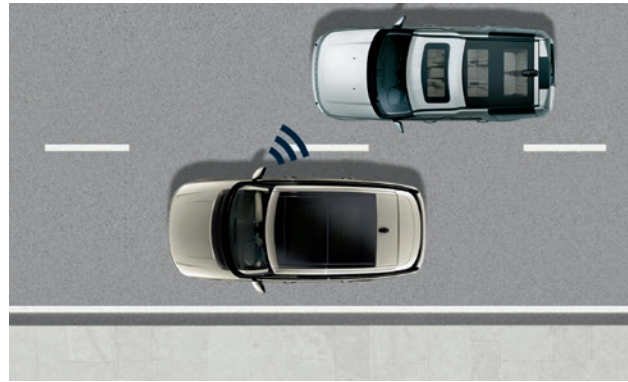

Blind Spot Monitor and Closing Vehicle Sensing

Using sensors mounted on the sides and the rear bumper, these systems are designed to see what you might miss. When a vehicle enters a blind spot, a warning light will show in the corresponding door mirror.

Closing Vehicle Sensing scans a zone much further behind the vehicle, to help detect vehicles which are closing quickly from behind, and which could cause a threat during a lane change manoeuvre.

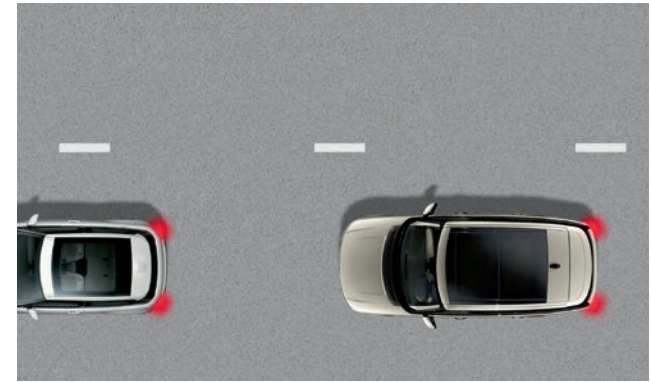

Safety

With driver and passenger airbags, side curtain and thorax airbags and active front seat belts linked to the vehicle's emergency braking functions, safety for all occupants is optimised.

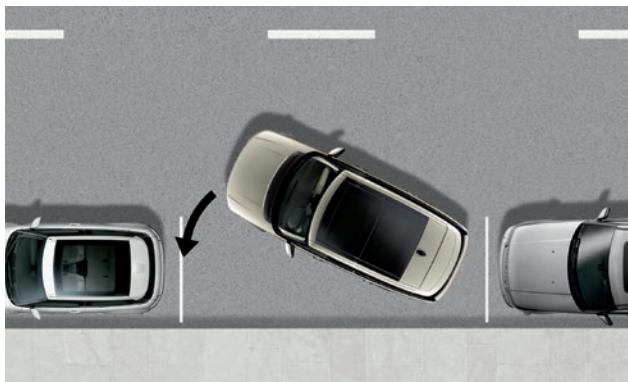

Parallel Parking

Using sensors, Parallel Parking identifies parking spaces and helps you parallel park in tight spots. The screen prompts you to select reverse and then automatically steers you into place. You stay in control using the brake and graphics guide you through each manoeuvre.



Reverse Traffic Detection

Using radar detectors in the rear of the vehicle the system is designed to warn you about potential collisions during reversing manoeuvres. The system can help detect a vehicle approaching from either side. When a target vehicle with a credible 'time to collision' is detected (a collision within three seconds or less), the system alerts the driver. Three warnings are given: an indicator lights up in the corresponding door mirror, an audible alert is sounded and a warning symbol is displayed on the camera screen.



360° Park Distance Control

With virtual object tracking along the sides of the car, 360° Park Distance Control gives confidence in confined situations, like multi-storey car parks at speeds up to 16 kph (10mph).

KEY FEATURES



Wade Sensing

The wade sensing feature assists the driver when crossing streams, fords and flooded roads, by using sensors in the wing mirrors and alerting the driver if the water is too deep.

This feature provides real-time pictorial wading information, including the depth of the water in relation to the vehicle, as well as maximum wading capability of the vehicle via the Touch-screen.



Interior Mood Lighting

The clean, elegant lines and premium materials of the interior are enhanced by carefully detailed LED mood lighting that brings the cabin alive at night. Following the lines of the veneer surface of the centre console, the lighting offers ten colours which can be chosen to suit your taste and mood.



Seat Comfort

The massage seats feature five programmes and are available for driver and passenger. Both front and rear seats have winged headrests and rear seat recline is standard on all vehicles.

Driver and Front Passenger Upper Seat Articulation is a new feature that allows the driver and front passenger to adjust the upper part of their seats, providing an extra level of comfort and functionality.



Audio

The Meridian™ audio technology gives you stunning sound quality. The top of the range system features Meridian Signature Reference Audio with 29 speakers including subwoofer, and 3D surround sound.



Surround Camera System

For a complete, all-round view, the latest surround camera system incorporating T-Junction view helps you see everything clearly on the full-colour Touch-screen. This system will also help you with towing as it includes trailer reverse park guidance and trailer hitch guidance.



Dual View Touch-Screen

Dual View technology enables driver and front passenger to view completely independent display content via the Touch-screen, so the passenger can watch TV while the driver follows navigational instructions.



Powered Tailgate

The characteristic Range Rover split tailgate is fully power operated. The upper tailgate can be opened remotely from the key fob or via a switch on the dash, or both gates can be independently operated using buttons on the tailgate, the key fob or from the driver's seat. To help prevent accidents the power operation will stop when it detects an obstruction.



Terrain Response® 2

Next generation Terrain Response® 2 is designed to monitor driving conditions and automatically optimises the vehicle's settings to suit the terrain giving you the ultimate in ride comfort on all surfaces including grass/gravel/snow, mud/ruts, sand and rock. And even if it is not in auto mode, it will let you know if you should select low range and off-road ride height.



Climate Control and Park Heat

Choose three-zone climate control, with separate controls for driver, front passenger and rear seats.

The optional four-zone climate control helps give more control to rear passengers. Remote Park Heat with Timed Climate enables you to pre-heat or cool the vehicle with remote control and seven-day timer.



Adaptive Dynamics

Standard on all vehicles, Adaptive Dynamics monitors the vehicle's movements at least 500 times a second, reacting to driver or road inputs virtually instantaneously, helping to give greater control and minimising body roll, for a composed ride. The system even senses off-road conditions, and optimises damping accordingly.



Rear Seat Entertainment System with 10.2 inch Screen

The Rear Seat Entertainment System provides big-screen entertainment for rear passengers, offering twin remote 10.2 inch rear seat mounted screens, a pair of WhiteFire® digital wireless headphones and a USB connector. It also includes 'Journey Status', a Navigation Summary screen which displays a pop-up for the rear occupant detailing the time and distance to destination.



Rear Executive Class Seating

Choose the Range Rover Autobiography and you can select Rear Executive Class seating. The ultimate in comfort, these two individual seats feature memory, powered headrest, rear centre console armrest, cushion adjustments, massage seats and power recline. The individual seats are divided by an elegant console that houses the controls and an optional cool box.

WhiteFire® is a registered trademark of Unwired Technology LLC and any use of such marks by Land Rover is under licence.

DIMENSIONS AND CAPABILITIES



Standard Wheelbase (SWB) 2,922mm



Height
SWB 1,835mm
LWB 1,840mm



Front wheel track 1,690mm



Rear wheel track 1,683mm

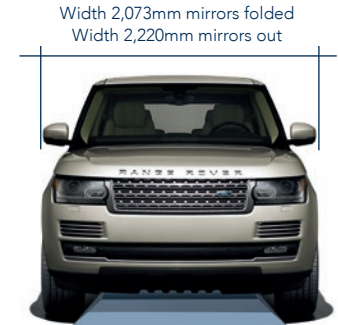

Width 2,073mm mirrors folded
Width 2,220mm mirrors out

Obstacle Clearance

Off-road height 296.1mm
Standard ride height 221.1mm



Long Wheelbase (LWB) 3,120mm

Standard Overall length 4,999mm (Long Wheelbase 5,199mm)



Turning Circle

Kerb-to-kerb 12.3m (Long Wheelbase 13.0m)
Wall-to-wall 12.7m (Long Wheelbase 13.4m)
Turns lock-to-lock 3.03

Standard Ride Height

With roof rails 1,836mm (LWB 1,840mm)
With panoramic roof open 1,874mm (LWB 1,880mm)
With Telematics roof antenna 1,860mm (LWB 1,866mm)
Access height air suspension setting will reduce each of the above by 50mm

Loadspace Capacity

Rear seats upright
Height 824mm, Width 1,290mm
Loadspace volume 909 litres
Loadspace width between arches 1,120mm
Length at floor 1,101mm

Rear seats forward
Height 824mm, Width 1,290mm
Loadspace volume 2,030 litres (LWB 2,345 litres)
Loadspace width between arches 1,120mm
Length at floor 1,985mm (LWB 2,177 mm)

Headroom

Maximum front headroom with panoramic roof 997mm
Rear headroom 996mm (LWB 973mm)



	A	B	B	C
Ride Height	Approach Angle	Ramp Angle	Ramp Angle (Hybrid)	Departure Angle
Off-road SWB / LWB	34.7	28.3 / 26.1	27.3 / 25.1	29.6
Standard SWB / LWB	26	20.1 / 18.4	19.6 / 17.9	24.6



Wading Depth

Maximum wading depth 900mm

Please note: Figures related to both Standard (SWB) and Long Wheelbase (LWB) models unless stated.

TECHNICAL SPECIFICATION / PERFORMANCE AND KEY DATA

	TDV6 190KW	SDV6 250KW HYBRID	SDV8 250KW	V6 SUPERCHARGED 250KW	V8 276KW	V8 SUPERCHARGED 375KW
ENGINE DATA						
Capacity (cc)	2,993	2,993	4,367	2,995	5,000	5,000
No. of cylinders	6	6	8	6	8	8
Cylinder layout	Longitudinal V6	Longitudinal V6	Longitudinal V8	Longitudinal V6	Longitudinal V8	Longitudinal V8
Valves per cylinder	4	4	4	4	4	4
Bore (mm)	84	84	84	84.5	92.5	92.5
Stroke (mm)	90	90	98.5	89	93	93
Compression ratio (:1)	16.1	16.1	16.1	10.5	11.5	9.5
Maximum power kW (PS) / rpm	190 (258) / 4,000	250 (340) / 4,000**	250 (339) / 3,500	250 (340) / 6,500	276 (375) / 6,500	375 (510) / 6,000-6,500
Maximum torque Nm / rpm	600 / 2,000	700 / 1,500-3,000**	700 / 1,750-3,000	450 / 3,500-5,000	510 / 3,500	625 / 2,500-5,500
BRAKES						
Front type	Ventilated disc	Ventilated disc	Ventilated disc	Ventilated disc	Ventilated disc	Ventilated disc
Front diameter (mm)	350	380	380	350	350	380
Rear type	Ventilated disc	Ventilated disc	Ventilated disc	Ventilated disc	Ventilated disc	Ventilated disc
Rear diameter (mm)	350	365	365	350	350	365
Park Brake	Electric Park Brake (EPB) integrated into brake caliper					
WEIGHTS (kg)						
Weight from (LWB)	2,160 (2,301)	2,394	2,410 (2,488)	2,222 (2,372)	2,198	2,330 (2,413)
Maximum laden weight (LWB)	3,000 (3,050)	3,100	3,200	3,050 (3,100)	3,000	3,150
Maximum mass on each axle (front)	1,500	1,550	1,550	1,500	1,500	1,550
Maximum mass on each axle (rear)	1,775	1,775	1,775	1,775	1,775	1,775
TOWING (kg)						
Unbraked trailer	750	750	750	750	750	750
Maximum towing	3,500	3,000	3,500	3,500	3,500	3,500
Maximum coupling point / nose weight	150	120	150	150	150	150
Maximum vehicle and trailer combination / Gross Train Weight	6,500	6,100	6,700	6,500	6,500	6,650
ROOF CARRYING (kg)						
Maximum roof load (including Roof Rails)	100	100	100	100	100	100
PERFORMANCE AND FUEL ECONOMY						
Maximum speed kph (mph)	210 (130)	218 (135)	218 (135)	210 (130)	210 (130)	225 / 250* (140 / 155*)
Acceleration (secs) 0-100kph (LWB)	7.9 (8.3)	6.9	6.9 (7.2)	7.4 (7.8)	6.8	5.4 (5.8)
Acceleration (secs) 0-60mph (LWB)	7.4 (7.8)	6.5	6.5 (6.6)	7.1 (7.4)	6.5	5.1 (5.5)
Fuel tank capacity – usable (litres)	85	80	105	105	105	105
Diesel Particulate Filter (DPF)	■	■	■	–	–	–

*Maximum speed for V8 Supercharged is 250kph (155mph) when specified with 22 inch wheels. Not available on LWB

**When combined with electric motor.

■ Standard – Not Available.

ACCESSORIES





Roof Rails*
Consult your Land Rover Dealer for further details

Maximum permissible load capacity 100kgs**. Design features pre-set positioning holes/dowels to ensure Cross Bars are fixed in optimum position for weight distribution and dynamics.

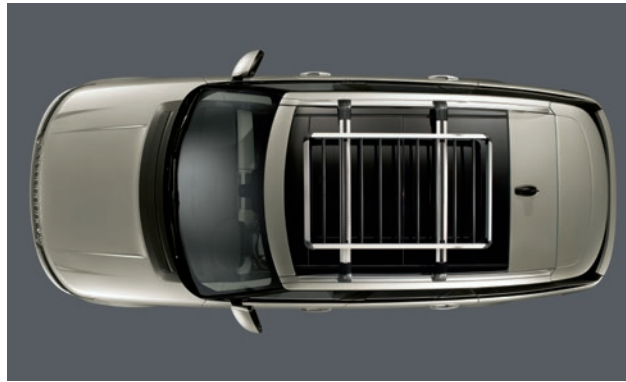

Cross Bars*
VPLGR0102

T-track design utilises the full length of the bars, providing space to mount multiple accessories. Aerodynamic profile minimises drag and noise. The incremental height when fitted is 93mm. Roof rails required for fitment.

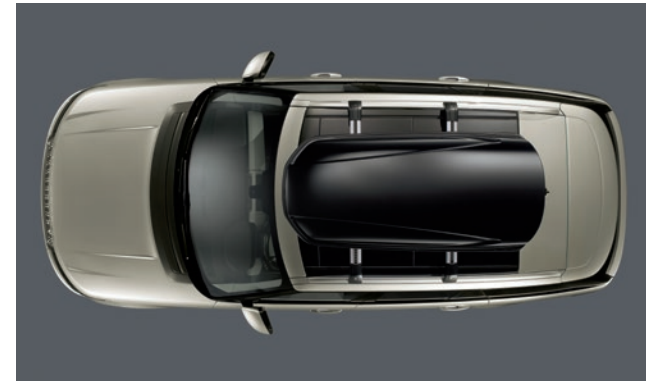

Luggage Carrier*
LR006848

Flexible rack system to facilitate roof carrying. Maximum payload 75kg**.

Luggage Box*
VPLVR0062

Available in a range of sizes, all versions can be mounted either side for kerbside opening in any country and include integral locks for security and peace of mind. Carrying capacity ranges from 320 litres with the Sports Box (below) to the 410 litre Luggage Box or the capacious 430 litre Large Roof Box. Maximum payload 75kg**.

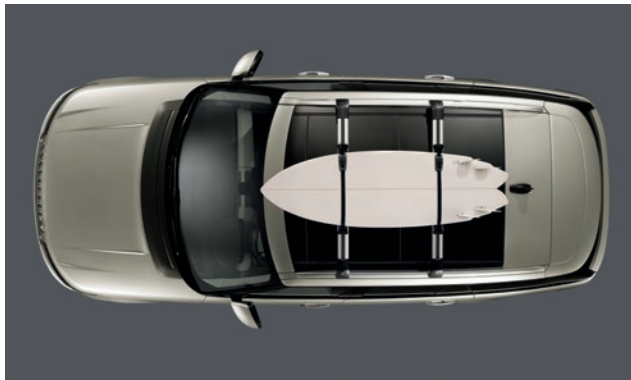

Aqua Sports Carrier*
VPLGR0107

Carries one surfboard, sailboard, canoe or kayak. Includes lockable multi-purpose holder to carry a mast, oars or paddles. Tilts to facilitate easy loading/unloading. Features lockable straps and rubber supports to maintain optimum weight distribution whilst protecting the kayak and vehicle from scratches/scuffs. Maximum payload 45kg/99.2lbs.



Ski/Snowboard Holder*
LR006849

Carries four pairs of skis or two snowboards. Lockable for security. Incorporates slider rails for easy loading. Maximum payload 36kg**.



Sports Box*
VPLVR0061

Large Roof Box*
VPLWR0100 (not shown)

*Roof Rails and Cross Bars are required for all Land Rover roof mounted accessories. Objects placed above the roof mounted satellite antenna may reduce the quality of the signal received by the vehicle and could have a detrimental effect on the navigation and satellite radio system, if fitted.

**Maximum payload equals the load capacity of the roof mounted accessory.

ACCESSORIES





Illuminated Treadplates
 VPLWS0208 – SWB
 VPLGS0261 – LWB

Illuminated treadplates are available on both the driver and front passenger sides of the vehicle to welcome you into the cabin.

Personalised Illuminated Treadplates
 VPLWS0212 – Front
 VPLWS0209 – Vehicle Set (SWB only)
 VPLGS0262 – Rear (LWB only)

Personalise your vehicle further by adding a script of your choice in a variety of fonts, highlighted by subtle white illumination. Available as a full vehicle set (front pair personalised, rear pair illuminated only) or as a front pair only.



Pedal Kit
 VPLGS0160 – LHD
 VPLGS0161 – RHD

Pedal caps feature Bright design and hidden fixings for a clean finish.



Noble Plated Mirror Caps
 VPLGB0073

Noble Plated Mirror Caps complement the Range Rover's exterior styling cues.

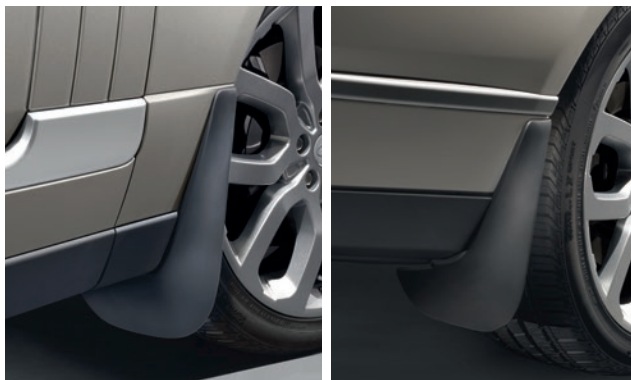

Front Mudflaps
 VPLGP0109

Mudflaps help reduce spray and help protect the paintwork. Supplied as a pair. Not for use with Deployable Side Steps.

Front Mudflaps (for Deployable Side Steps)
 VPLGP0111

Rear Mudflaps
 VPLGP0110



Electrically Deployable Tow Bar
 VPLGT0117, VPLGB0108, VPLGT0109, VPLGT0108

The Electrically Deployable Tow Bar is stowed discreetly behind the bumper, providing a clean attractive finish. It is designed to deploy/stow in 12 seconds. It's sensitive to obstructions and will stow automatically if necessary. Approved for up to 3,500kg trailer load.

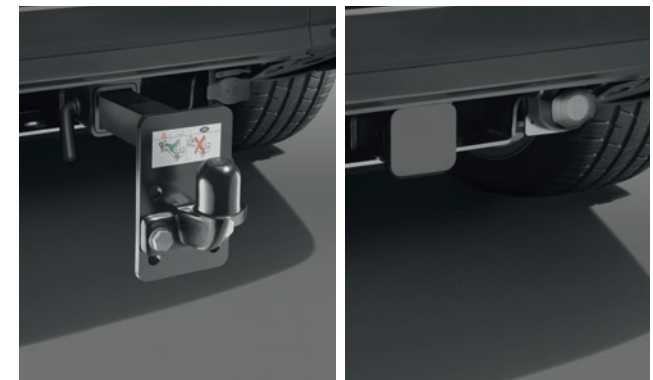

Multi-Height Tow Bar and Armature
 VPLGT0082, VPLGT0097,
 LR037931, LR037913

Offers three different towing height options and the ability to swap heights in a matter of seconds. Approved for 3,500kg trailer load. Requires Towing Electrics – 13 Pin for fitment.

Towing Electrics – 13 Pin*
 VPLGT0073

European-style towing electrics, capable of supplying all trailer rear lighting and interior equipment power. Provided for use with Multi-Height Tow Bar.

*Please note: These accessories are not suitable for caravans, trailers or lighting boards fitted with rear mounted LED Lamp Kits.

ACCESSORIES



Loadspace Rails and D Loops
VPLGS0170

Loadspace mounted rails to help increase the flexibility of loadspace storage. Loadspace Rails allow fitment of the Luggage Retention Kit storage system.

Luggage Retention Kit*
VPLGS0171

Pack of attachments that fix into the Loadspace Rails via a quick lock/quick release system to help provide a flexible solution for retaining items. The attachment pack includes a retractable strap with inertia reel, telescopic rod and stowage bag.



Loadspace Mat – Rubber
VPLGS0151

Range Rover branded rubber mat helps protect the rear loadspace carpet from general dirt. Waterproof and non-slip surface.



Loadspace Semi-Rigid Liner
VPLGS0152

Range Rover branded rubber mat helps protect the rear loadspace carpet from general dirt. Semi-rigid waterproof loadspace protector adds a raised lip feature on three sides to protect side wall carpets.



Rubber Footwell Mats
VPLGS0150 – SWB LHD / VPLGS0149 – SWB RHD
VPLGS0254 – LWB LHD / VPLGS0255 – LWB RHD

Rubber footwell mats for front and second row occupants help provide protection from general dirt.



Cargo Barrier – Full height
VPLGS0162

This useful barrier helps prevent cargo from entering the passenger compartment. Incorporates integral ski hatch. Complies with EC regulation 17. Not compatible with Rear Executive Class seating.



Tow Bar Mounted Bike Carrier
Two Bike Carrier – VPLVR0067 – LHD / VPLVR0066
Three Bike Carrier – VPLVR0069 – LHD / VPLVR0068

Upper and lower tailgate can be opened with carrier in place. Features quick attach/release mechanism. Fits to either Multi-Height Tow Bar or Electrically Deployable Tow Bar. Manufactured from aluminium and other lightweight materials. Lockable for security. Maximum load capacity 40kgs.

More information on Land Rover bikes is available online at:
www.2x2worldwide.com



Deployable Side Steps
Consult your Land Rover Dealer for further details

These smart, practical steps make it easier to get in and out of the vehicle. Neatly stowed under the sills, the Side Steps automatically deploy as soon as the door is opened, or when activated by the key fob. They stow automatically when the door is closed. The Side Steps are sensitive to obstructions and will not deploy in off-road or low range settings.

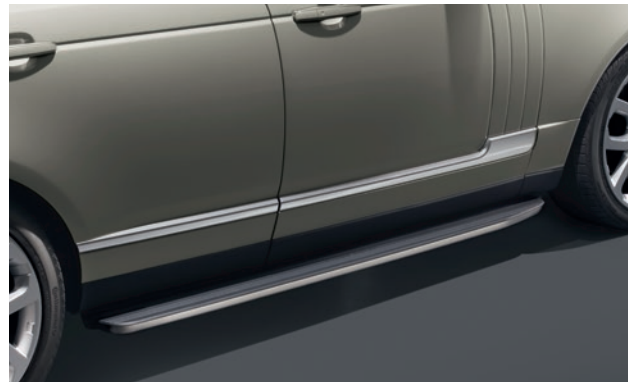

Fixed Side Step
VPLGP0114 (SWB only)

The Fixed Side Step aids entry and exit to the vehicle and improves access to the roof. Not available on Long Wheelbase.

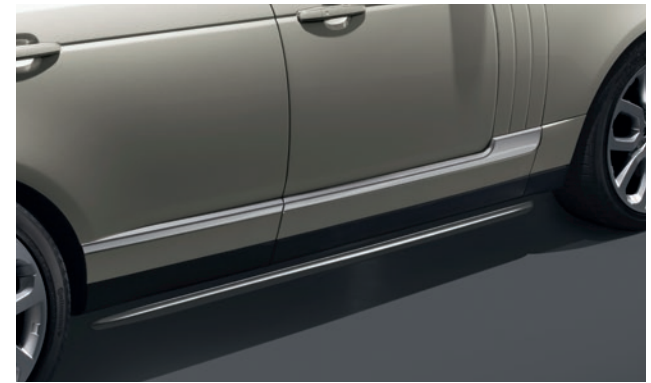

Side Protection Tubes
VPLGP0100 (SWB only)

Manufactured from stainless steel, this product helps protect the vehicle in off-road conditions. Its rugged off-road appearance complements the vehicle's exterior design. Not available on Long Wheelbase.



Accessory Wheels**

The full range of wheels are also available as an accessory fitment. Wheels shown are manufactured via premium forging process to ensure strength, with striking vibration polished finish.



Styled Valve Caps
LR027664 – Black Jack
LR027666 – Union Jack
LR027560 – Land Rover
LR027663 – Range Rover

Enhance your alloy wheels with the genuine Land Rover valve cap accessories that are offered in a range of styles.



iPad® Holder
VPLVS0165 – iPad® 2
VPLVS0164 – iPad® 1

Provides secure mounting for your iPad. Rear seat facing, attaches to the head restraint posts.

iPad is a registered trademark of Apple Inc., registered in the US and other countries.

**Rim only. Centre cap not included.

For a full list of Accessories visit landrover.com





BY APPOINTMENT TO
H.M. THE QUEEN
MANUFACTURERS OF
MOTOR VEHICLES
JAGUAR LAND ROVER LIMITED
COVENTRY



BY APPOINTMENT TO
H.R.H. THE DUKE OF EDINBURGH
MANUFACTURERS OF
MOTOR VEHICLES
JAGUAR LAND ROVER LIMITED
COVENTRY



BY APPOINTMENT TO
H.R.H. THE PRINCE OF WALES
MANUFACTURERS OF
MOTOR VEHICLES
JAGUAR LAND ROVER LIMITED
COVENTRY

IMPORTANT NOTICE: Jaguar Land Rover Limited is constantly seeking ways to improve the specification, design and production of its vehicles and alterations take place continually. Whilst every effort is made to produce up to date literature, this brochure should not be regarded as an infallible guide to current specifications, nor does it constitute an offer for the sale of any particular vehicle. Distributors and dealers are not agents of Jaguar Land Rover Limited by any express or implied undertaking or representation.

All Land Rover Approved Accessories fitted by a Land Rover Dealer within one month or 1,600 kilometres/1,000 miles (which ever occurs first) of the handover of a new registered vehicle will benefit from the same warranty terms and period of cover as the vehicle warranty. Accessories purchased outside of these parameters will be subject to a 12 month unlimited mileage warranty. All Land Rover Approved Accessories are rigorously tested to the same exacting standards as those applied to our vehicles. Performance in extreme hot and cold temperatures, corrosion resistance, impact and airbag deployment highlight some of the exhaustive product testing carried out to ensure accessories are both durable and importantly, continue to comply with current legislation.

All our accessories are designed to be an integral part of Land Rover vehicles. While many items such as roof carriers are simple to fit, some products require specialist tools and diagnostic equipment to ensure correct integration with the vehicle structure and electrical systems. These products vary from market to market, please consult your Land Rover Dealer who will be pleased to advise you on current specifications and any query you may have.

The colours reproduced here are subject to the limitations of the printing process and may therefore vary slightly from the actual vehicle. The company reserves the right to alter or withdraw any colour finish without notice. Some of these colours may not be obtainable in your country. Please check availability of colours and current specifications with your Land Rover Dealer. Distributors and dealerships are not agents of Jaguar Land Rover Limited and have absolutely no authority to bind Jaguar Land Rover Limited to any express or implied undertaking or representation.

Jaguar Land Rover Limited Registered Office:
Abbey Road, Whitley, Coventry CV3 4LF
United Kingdom.

Registered in England: Number 1672070

landrover.com

© Jaguar Land Rover Limited 2013. Publication Number: LRML 4440/14

