

The BMW 2 Series
Gran Tourer
Active Tourer



The Ultimate
Driving Machine

www.bmw.co.uk
www.bmw.ie

THE BMW 2 SERIES GRAN TOURER AND ACTIVE TOURER.

BMW EFFICIENT DYNAMICS.
LESS EMISSIONS. MORE DRIVING PLEASURE.

THE NEXT
100 YEARS





In 2016 the BMW brand will be celebrating its 100th anniversary. Find out more at www.next100.bmw



WANT TO DISCOVER MORE?



Discover the BMW 2 Series Active Tourer and BMW 2 Series Gran Tourer in digital, with videos and image galleries. Simply download the interactive BMW brochure app for your device and select the model of your choice.

Depending on the terms of your mobile phone plan you might incur additional costs for accessing the internet.

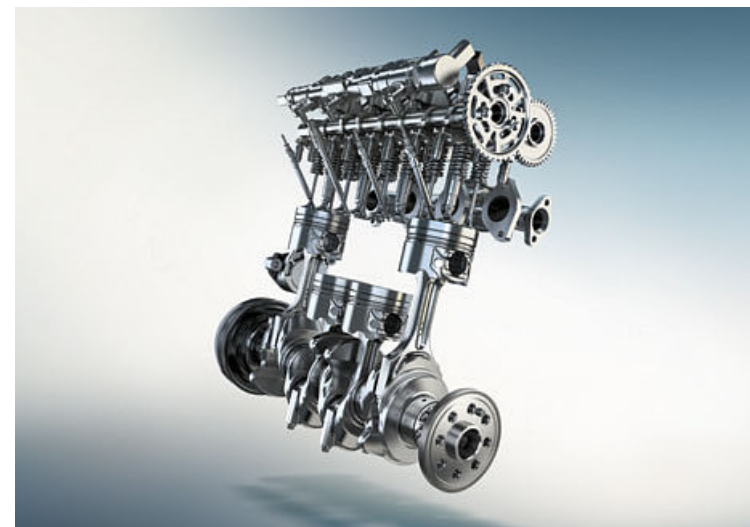

THE BMW 2 SERIES GRAN TOURER. THE BMW 2 SERIES ACTIVE TOURER.

FEATURED MODELS.

04 BMW 2 SERIES 220d xDRIVE SPORT GRAN TOURER: BMW TwinPower Turbo four-cylinder diesel engine, 190hp (140kW), 18" light alloy Y-spoke style 484 wheels, Flamenco Red Xirallic metallic paint, seats upholstered in Black Dakota leather with perforation, Red highlight and Red stitching, Brushed Aluminium interior trim with Pearl Chrome finisher.

BMW 2 SERIES 225i xDRIVE LUXURY ACTIVE TOURER: BMW TwinPower Turbo four-cylinder petrol engine, 231hp (170kW), 18" light alloy V-spoke style 485 wheels, Platinum Silver metallic paint, seats upholstered in Canberra Beige Dakota leather with perforation and Grey stitching, Finesline Shore wood trim interior trim with inlays and Pearl Chrome finisher.

BMW 2 SERIES 225xe iPERFORMANCE LUXURY ACTIVE TOURER: BMW TwinPower Turbo three-cylinder petrol engine, 136hp (100kW), 18" light alloy V-spoke style 485 wheels, Glacier Silver metallic paint, seats upholstered in Canberra Beige Dakota leather with perforation and Grey stitching, Finesline Shore wood trim interior trim with inlays and Pearl Chrome finisher.

INNOVATION AND TECHNOLOGY.

- 24 BMW TWIN POWER TURBO ENGINES:** At the heart of BMW EfficientDynamics.
- 26 BMW EFFICIENT DYNAMICS:** Making light work of lower fuel consumption.
- 28 BMW CONNECTED DRIVE:** In touch with your world.
- 30 SUSPENSION:** Innovative systems for more driving pleasure.
- 31 SAFETY:** Technology at the highest level.

INDIVIDUALITY AND CHOICE.

- 34 EQUIPMENT:** SE, Sport, Luxury and M Sport, BMW 225xe iPerformance Active Tourer, Equipment Highlights, Wheels and Tyres and Genuine BMW Accessories.
- 50 COLOURS:** Exterior, interior and upholstery colours.
- 54 BMW SERVICES:** BMW Service, BMW Financial Services and BMW Experience.

ROCK 'N' ROLL.

Newcomer of the year. The BMW 2 Series Gran Tourer unites functionality and spaciousness with typical BMW characteristics: driving pleasure and dynamics. From any perspective, it makes a great impression, offering plenty of space and the greatest possible flexibility. Whether you're enjoying its athleticism or taking a ride to a concert with the band, in the BMW 2 Series Gran Tourer, going on tour is always a hit.



WORKS HARD. PLAYS HARD.

Versatility shows its athletic side. With the BMW 2 Series Gran Tourer, BMW has proven just how good a spacious vehicle can look. The athletic body dynamically propels itself forward, driven by the newest generation of BMW TwinPower Turbo engines. This model is the first in its class to be equipped with intelligent xDrive all-wheel-drive, providing even more driving pleasure and an extra dose of security. This means that it only raises your pulse when you want it to.





GROUP DYNAMICS.

Room for a solo. Or for the whole band. In the BMW 2 Series Gran Tourer, there's no either/or because there's plenty of room for all. A driver-orientated cockpit, room for up to seven people plus a high ceiling and large doors make for easy entry. Functional storage options and a rear seat that can be shifted laterally provide optimal flexibility and on top of it all: an optional panoramic glass sunroof will flood the interior with light. Once you're behind the wheel, you'll get the best of everything whatever the arrangement.



THE PERFECT COMPANION.

Beautifully compact on the outside, beautifully flexible on the inside. The BMW 2 Series Active Tourer shows how much fun functionality can be. With its distinctive contours and dynamic lines it perfectly combines everyday practicality with driving pleasure. It makes everyday life more exciting and long trips more relaxed so no matter what you get up to, it's incredibly fun.





LOOKS RIGHT. DRIVES RIGHT.

The BMW 2 Series Active Tourer has everything you expect of a BMW. The low-set tailgate with the classic BMW L-shaped lights gives the vehicle an athletic touch. The premium-quality interior is both spacious and inviting.

ROOM FOR EVERYTHING. EXCEPT BOREDOM.

Enjoy its size. There are numerous reasons why travelling in the BMW 2 Series Active Tourer can feel like a real treat: Its spaciousness, elevated seating position, ample head and leg room in the rear, and last but not least, is the fact that stacks of luggage will not be a problem as both the rear seat backrests and the front passenger backrest can be folded down flat.¹

¹ Folding front passenger backrest optionally available on SE and Luxury models (without Sport seats and electric front seats).



WELCOME TO THE FAMILY.

Functional, flexible and fit. The BMW 2 Series Gran Tourer and BMW 2 Series Active Tourer, also available as a plug-in-hybrid, make the everyday exceptional. All models offer plenty of space while remaining fun to drive – whatever type of engine you opt for. Relish the sportiness typical of BMW, making every trip an adventure.





ELECTRIFYING DRIVING ENJOYMENT.

The BMW 2 Series iPerformance Active Tourer combines advanced technology with maximum driving pleasure. The perfect interplay of the three-cylinder petrol engine, electric motor and lithium ion high-voltage battery allows you up to 25 miles with all electric driving. Perfect for driving in the city completely emission free. Thanks to the 360° electric charging from your home, you are ready for your next adventure at anytime. Experience sustained enthusiasm – the BMW 2 Series iPerformance Active Tourer.

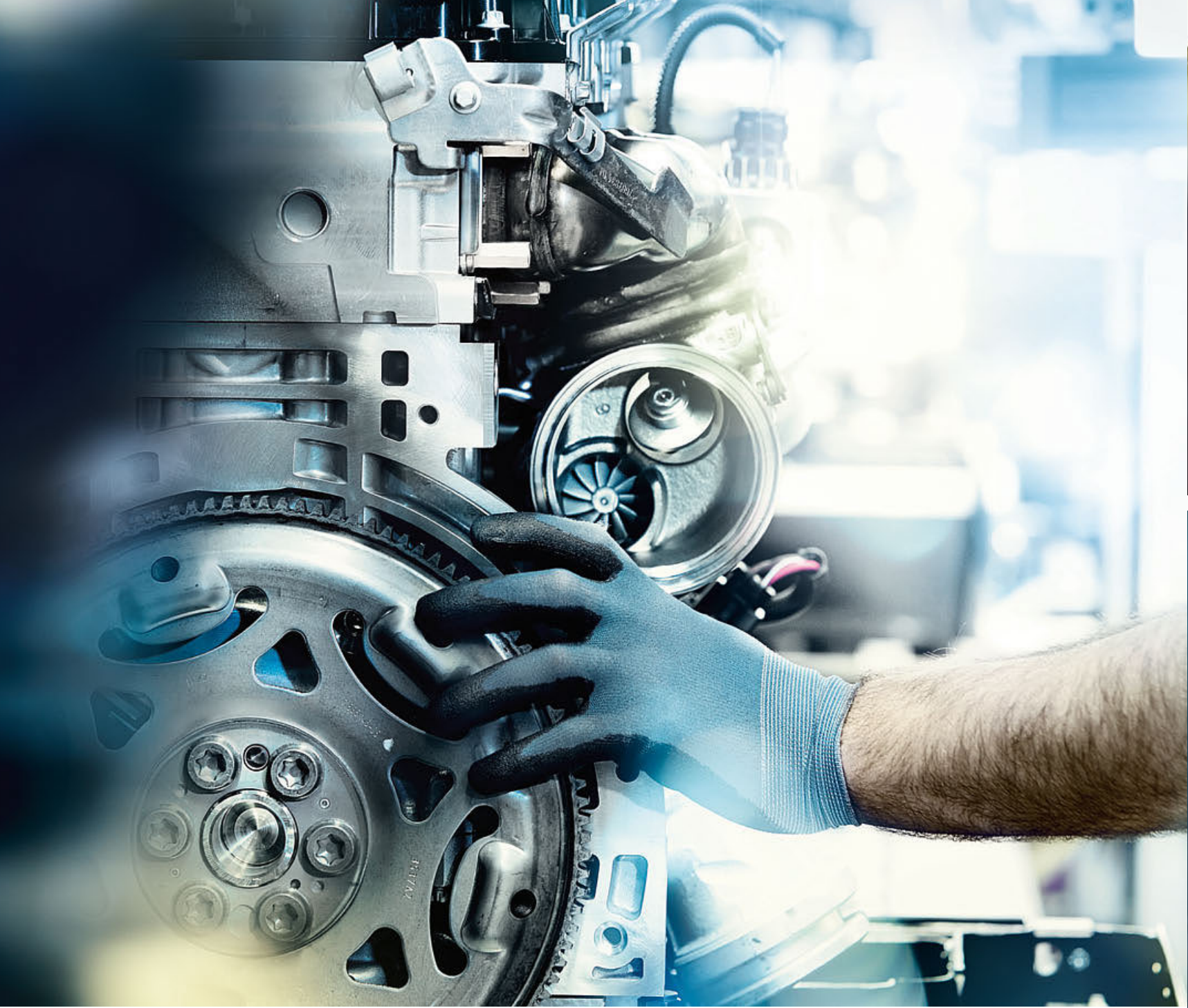

INNOVATION AND TECHNOLOGY.

BMW TWIN POWER TURBO ENGINES: At the heart of BMW EfficientDynamics.

BMW EFFICIENT DYNAMICS: Making light work of lower fuel consumption.

BMW CONNECTED DRIVE: In touch with your world.

SUSPENSION: Innovative systems for more driving pleasure.

SAFETY: Technology at the highest level.

BMW TwinPower Turbo engines. At the heart of BMW EfficientDynamics.

BMW TwinPower Turbo technology gives the new engines in the BMW EfficientDynamics engine range significantly more agile power delivery, as well as more spontaneous responsiveness even at low engine speeds. At the same time, they are efficient, with low emissions, low fuel consumption, great dynamics and increased driving pleasure.

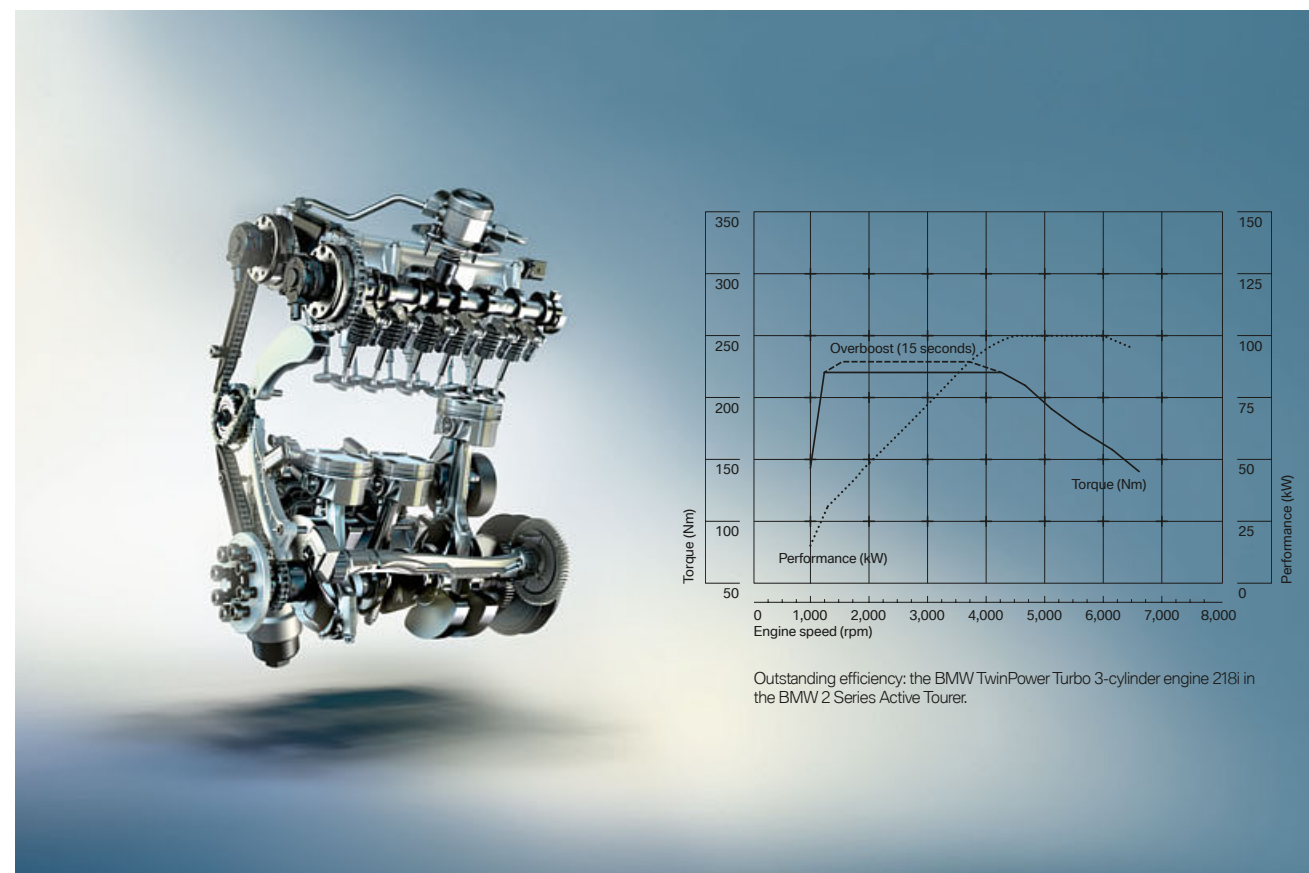

BMW TWIN POWER TURBO THREE-CYLINDER PETROL ENGINE 218i.

A true highlight of the BMW 2 Series Active Tourer is the BMW 218i. Its top-performing three-cylinder engine propels the vehicle from 0 to 62 mph in 9.3 seconds, peaking out at a top speed of 127mph. Even with such a remarkable performance, this very low-friction, highly efficient engine is impressively frugal.

BMW TWIN POWER TURBO FOUR-CYLINDER DIESEL ENGINE 220d.

The BMW 2 Series Gran Tourer 220d offers agile power delivery and outstanding responsiveness even at low engine speeds. The BMW TwinPower Turbo four-cylinder diesel engine produces an exceptional 190hp (140kW) performance so it is as thrifty as it is a low pollutant.

BMW 225i xDrive Active Tourer.¹

- BMW TwinPower Turbo four-cylinder petrol engine with 231hp (170kW) and 350Nm of torque
- Acceleration 0–62mph: 6.3 seconds
- Top speed: 146mph (235km/h)
- Combined fuel consumption: 43.5–44.1mpg (6.5–6.4l/100km)
- CO₂ emissions: 148–152g/km

BMW 220i Active Tourer / Gran Tourer.¹

- BMW TwinPower Turbo four-cylinder petrol engine with 192hp (141kW) and 280Nm of torque
- Acceleration 0–62mph: 7.4 seconds / 7.8 seconds
- Top speed: 142mph (228km/h) / 137mph (221km/h)
- Combined fuel consumption: 50.4mpg (5.6l/100km) / 47.1mpg (6.0l/100km)
- CO₂ emissions: 130g/km / 139g/km

BMW 218i Active Tourer / Gran Tourer.

- BMW TwinPower Turbo three-cylinder petrol engine with 136hp (100kW) and 220Nm of torque
- Acceleration 0–62mph: 9.3 seconds [9.2 seconds] / 9.8 seconds
- Top speed: 127mph (205km/h) / 127mph (205km/h) [126mph (203km/h)]
- Combined fuel consumption: 53.3–55.4mpg (5.1–5.3l/100km) / 50.4–53.3mpg (5.6–5.3l/100km)
- CO₂ emissions: 119–124g/km / 123–130g/km

BMW 220d xDrive Active Tourer / Gran Tourer.¹

- BMW TwinPower Turbo four-cylinder diesel engine with 190hp (140kW) and 400Nm of torque
- Acceleration 0–62mph: 7.3 seconds / 7.8 seconds
- Top speed: 138mph (222km/h) / 135mph (218km/h)
- Combined fuel consumption: 57.6–60.1mpg (4.9–4.7l/100km) / 55.4–57.6mpg (5.1–4.9l/100km)
- CO₂ emissions: 124–129g/km / 129–134g/km

BMW 220d Active Tourer / Gran Tourer.

- BMW TwinPower Turbo four-cylinder diesel engine with 190hp (140kW) and 400Nm of torque
- Acceleration 0–62mph: 7.6 seconds [7.5 seconds] / 8.1 seconds [8.0 seconds]
- Top speed: 141mph (227km/h) [139mph (224km/h)] / 138mph (222km/h) [137mph (220km/h)]
- Combined fuel consumption: 62.8–65.7mpg (4.5–4.3l/100km) / 60.1–62.8mpg (4.7–4.5l/100km)
- CO₂ emissions: 113–119g/km / 119–124g/km

BMW 218d Active Tourer / Gran Tourer.

- BMW TwinPower Turbo four-cylinder diesel engine with 150hp (110kW) and 330Nm of torque
- Acceleration 0–62mph: 8.9 seconds / 9.5 seconds
- Top speed: 129mph (208 km/h) [130mph (210km/h)] / 127mph (205km/h) [129mph (207km/h)]
- Combined fuel consumption: 65.7–68.9mpg (4.3–4.1l/100km) / 62.8–64.2mpg (4.5–4.4l/100km)
- CO₂ emissions: 109–114g/km / 115–119g/km

BMW 216d Active Tourer / Gran Tourer.

- BMW TwinPower Turbo three-cylinder diesel engine with 116hp (85kW) and 270Nm of torque
- Acceleration 0–62mph: 10.6 seconds / 11.4 seconds [11.2 seconds]
- Top speed: 121mph (195km/h) / 119mph (192km/h)
- Combined fuel consumption: 68.9–74.3mpg (4.1–3.8l/100km) / 65.7–68.9mpg (4.3–4.1l/100km)
- CO₂ emissions: 99–108g/km / 108–114g/km

BMW 225xe Active Tourer.¹

- BMW TwinPower Turbo three-cylinder petrol engine and electric motor with combined system output of 224hp (165kW) and 385Nm of torque
- Acceleration 0–62mph: 6.7 seconds
- Top speed: 125mph (202km/h)
- Combined fuel consumption: 134.5–141.2mpg (2.1–2.0l/100km)
- CO₂ emissions: 46–49g/km

BMW EFFICIENT DYNAMICS.
LESS EMISSIONS. MORE DRIVING PLEASURE.

¹ Automatic transmission only.
Values in [] refer to the vehicles with automatic transmission. Fuel consumption and CO₂ emissions are affected by the selected wheel and tyre sizes.

BMW EfficientDynamics

Making light work of lower fuel consumption.

Whether the goal is maximum performance or minimum fuel consumption – for us, the focus is always on delivering quintessential BMW driving pleasure. BMW EfficientDynamics is the strategy developed by BMW to minimise fuel consumption and CO₂ emissions while simultaneously increasing dynamics and driving pleasure. It's a comprehensive technology package that encompasses the engine, energy management and the vehicle concept – and is standard in every BMW.

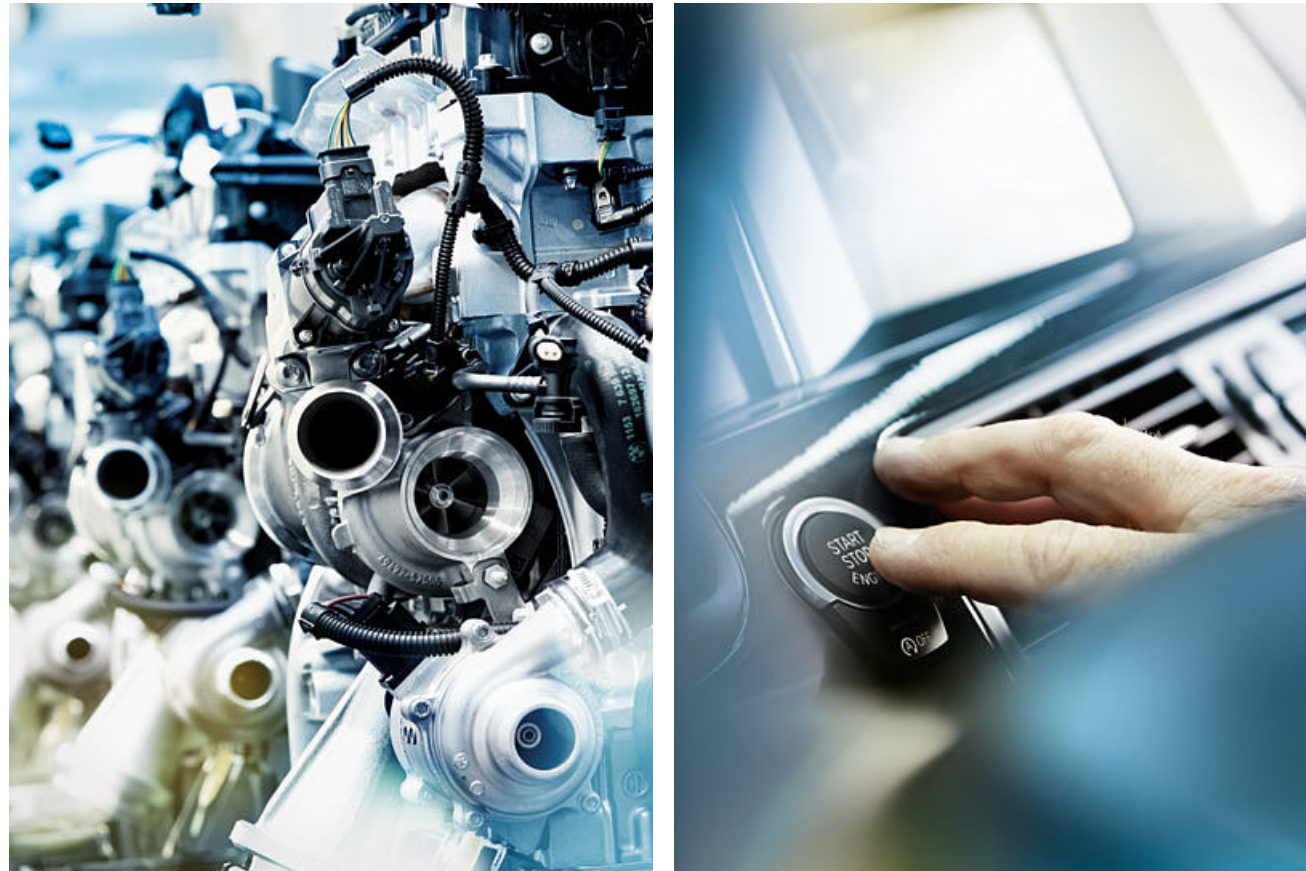

EXCEPTIONAL: ECO PRO MODE.

ECO PRO mode helps drivers reduce their fuel consumption by up to 20%, depending on their driving style – according to an internal BMW fuel consumption study. For example, ECO PRO will advise the driver to accelerate less aggressively, the optional eight-speed automatic transmission shifts even faster to higher gears and the automatic air conditioning is subject to energy optimised settings.



ENGINE.

The BMW TwinPower Turbo technology concept is used in all BMW **petrol engines**. Innovative turbocharger technology combined with High-precision direct injection and fully variable Valvetronic engine management, including Double-VANOS, all serve to improve performance, provide exceptional responsiveness even at low engine speeds and reduce fuel consumption.

Diesel engines combine the latest fuel injection technologies and fully variable vane geometry with innovative turbocharger technology for enhanced efficiency and a more dynamic performance. All available engines feature a lightweight aluminium design and come with a maintenance-free particle filter.

OVERALL CONCEPT.

BMW has been utilising intelligent lightweight construction since the 1930s. Exceptionally light materials are used for certain carefully selected parts of the car body – such as aluminium in the suspension and at the front of the car. This contributes to lower fuel consumption and higher performance, while maintaining maximum passive safety.

ENERGY MANAGEMENT.

Auto Start-Stop automatically switches off the engine when the vehicle is stationary. As soon as you engage the clutch (manual) or take your foot off the brake (automatic), the engine immediately starts up again and your journey continues. And without any effort on your part, you've saved fuel and helped protect the environment.

Optimum Shift Indicator. Changing gear at the right time can produce significant fuel savings. The optimum gear shift indicator tells you which gear you should select to increase fuel efficiency. The display is conveniently positioned directly in your line of vision. Depending on your driving style, the system also recommends how to go up and down the gears more effectively.

Brake Energy Regeneration. Now when you brake, you won't just be slowing yourself down, you'll be helping to keep your car moving. It sounds counter-intuitive, but whenever you apply the brakes or take your foot off the accelerator, you recycle energy instead of wasting it. Brake Energy Regeneration then uses this energy to recharge the battery. In the process, it reduces the demand on your engine, means you consume less fuel and keeps down your emissions.

BMW ConnectedDrive

In touch with your world.

Our world is becoming more connected every day with instant access to information at any time and any place. With your BMW being an integral part of your lifestyle we believe it's important that you can keep up to date from behind the wheel. BMW ConnectedDrive delivers intelligent solutions that allow you to remain connected whilst on the move.



Advanced driver assistance systems can connect you to the outside world so that you know exactly what is happening around you, premium traffic solutions ensure you are taking the most time efficient route whilst online services provide direct access to information about your current location or chosen destination. Today, driving enjoyment is derived as much from being informed and relaxed as it is from impressive performance and efficiency – discover how the comprehensive range of **BMW ConnectedDrive Services** and technologies can enhance the connected capabilities of your Ultimate Driving Machine.

For more information please visit:

➤ www.bmw.co.uk/connecteddrive
➤ www.bmw.ie/connecteddrive

Wherever your journey may lead, you can stay in touch with **BMW ConnectedDrive Services**. The range of innovative functions provide optimum integration between the driver, vehicle and the world outside – anytime, anywhere. The comprehensive advanced driver assistance systems seamlessly integrate the driver into their immediate environment. Headlights, sensors and cameras can combine to ensure the driver is fully informed about what is happening around them, delivering superior comfort and convenience as well as enhanced safety for both passengers and other road users.



Head-up Display. The optional full colour Head-up Display projects important information directly into the driver's field of vision. The information displayed can be customised in the vehicle settings and includes the current speed of travel, navigation instructions or telephone and music listings. This convenient display ensures that your eyes are always on the road ahead for a safer driving experience.



Concierge Service.¹ The optional Concierge Service connects you to a BMW operator who will be able to quickly access the information you need. So whether you are looking for a nearby hotel, restaurant or simply can't find your way then support is conveniently on hand. Information can be sent directly to your BMW so that addresses can be transferred to your Navigation system.

Driving Assistant. A tailored combination of camera-based driver assistance systems provide an enhanced safety and reduce the risk of potential collisions, at both high and low speeds. Lane Departure Warning detects lane markings and alerts the driver with a vibration through the steering wheel should the vehicle unintentionally deviate from the lane of travel. Collision Warning monitors the vehicles ahead and warns the driver by an optical and acoustic alert if their approach could escalate into a rear-end collision.

¹ Only as part of ZNQ Navigation Plus package.

Suspension.

Innovative systems for more driving pleasure.



The intelligent **BMW xDrive all-wheel-drive system** adapts perfectly to even the most challenging road conditions, ensuring outstanding traction at all times. With xDrive and standard Dynamic Stability Control (DSC), the vehicle remains directionally stable and on track. Split-second response times allow xDrive to distribute drive power flexibly between the two axles for optimum grip. In this way, xDrive combines the advantages of all-wheel-drive (traction, directional stability and safety) with classic BMW agility.

Standard **Drive Performance Control** lets the driver choose between the standard Comfort mode, ECO PRO mode, which is geared towards efficiency, and Sport mode, which enables even more dynamic driving. ECO PRO adjusts the characteristics of the accelerator pedal and transmission as well as the heating/air conditioning settings to suit the driving situation.

The optional **Variable Sport steering** with Servotronic enables a direct and agile driving style with less physical effort when steering. Independently of your current speed, it reacts by varying the steering ratio in line with the steering angle. This reduces the steering movement required when steering at particularly large angles. It features speed-dependent and variable power steering. This significantly increases agility and improves handling when driving dynamically through sharp bends and corners, or when swerving to avoid obstacles. It also makes parking, turning and manoeuvring easier.¹

The optional **Electronic Damper Control** allows the driver to adapt the shock absorber characteristics to suit the driving conditions, thus enhancing ride comfort and driving dynamics. In addition to the standard Comfort mode, there is also Sport mode for even more dynamic driving enjoyment.¹

¹ Variable Sport steering and Electronic Damper Control is not available for 225xe Active Tourer.

Safety.

Technology at the highest level.

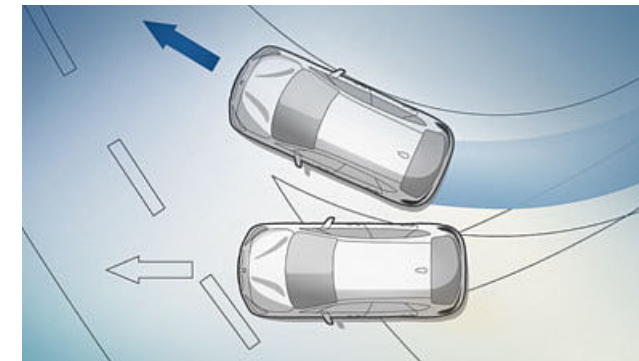

■ **Dynamic Stability Control (DSC)** continually assesses the vehicle's movements and optimises directional stability and traction by intervening in engine and brake management. This makes it much easier to control the vehicle, even on difficult surfaces, actively increasing driving safety.

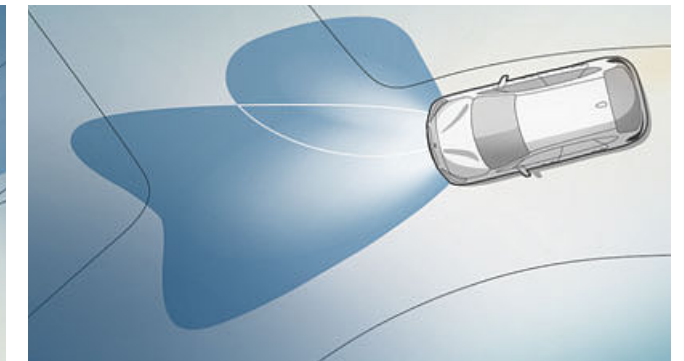

□ **Adaptive LED Headlights** with variable light control, including cornering lights, help increase driving safety by optimally illuminating the road ahead. Light distribution is automatically adapted to match your speed and the steering angle.

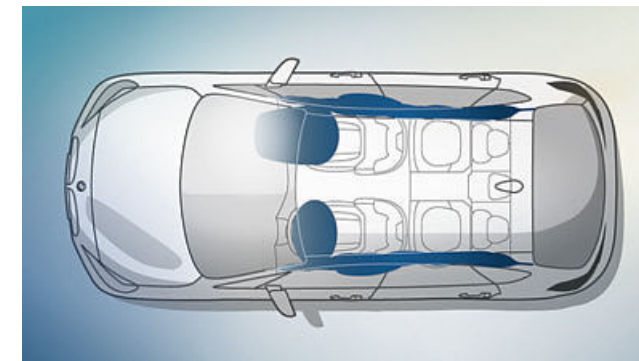

■ **Airbags** for the driver and front passenger, head airbags as well as side airbags integrated into the front seat backrests provide strategic protection.

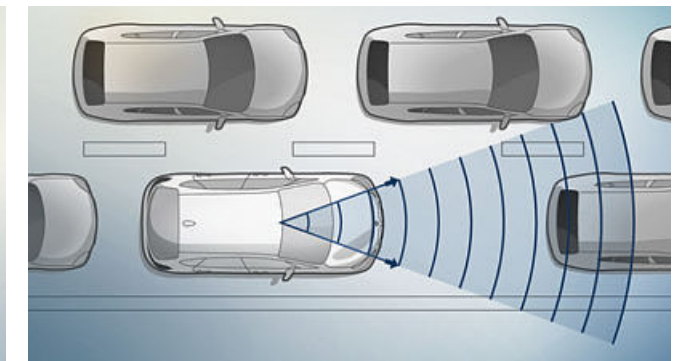

□ **Traffic Jam Assist**, this optional feature steers, controls and maintains the speed and distance to the car ahead in congested traffic in speeds up to 37mph.

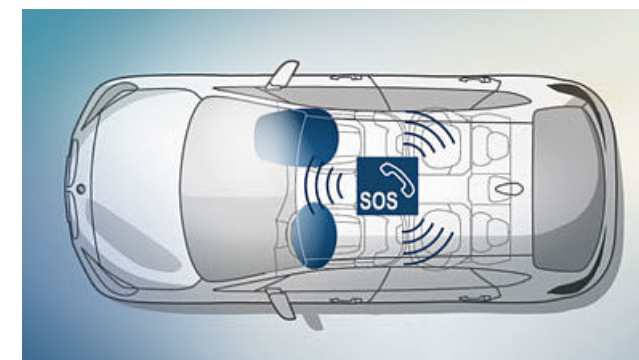

■ **BMW Emergency Call** establishes a connection to the local Emergency Services using the vehicles built-in SIM card. This allows for immediate action to be taken and assistance despatched without delay.

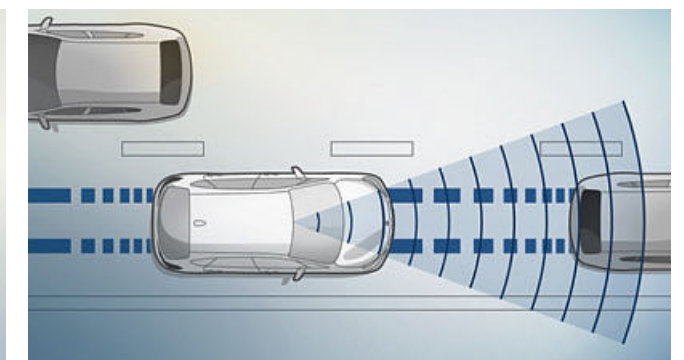

□ **Driving Assistant** includes Forward Collision Warning which detects vehicles in front and warns the driver when they are too close. Lane Departure Warning alerts the driver if the vehicle strays from the lane of travel without indicating.



INDIVIDUALITY AND CHOICE.

EQUIPMENT: SE, Sport, Luxury and M Sport, BMW 225xe iPerformance Active Tourer, Equipment Highlights, Wheels and Tyres and Genuine BMW Accessories.

COLOURS: Exterior, interior and upholstery colours.

BMW SERVICE: BMW Service, BMW Financial Services and BMW Experience.

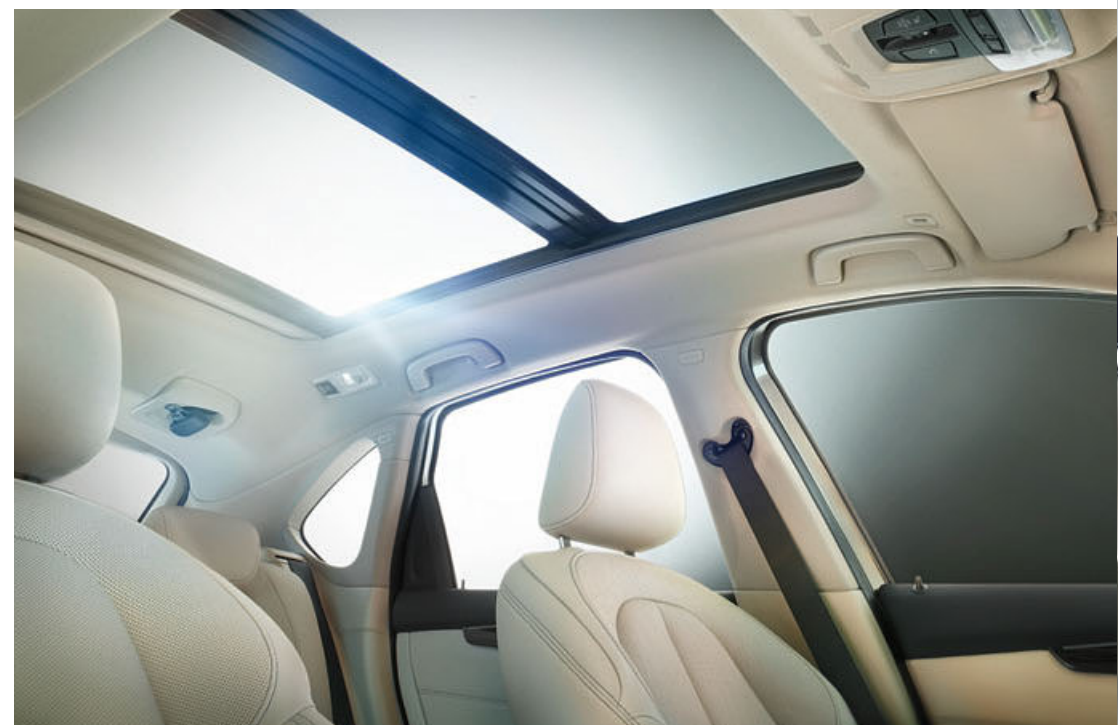
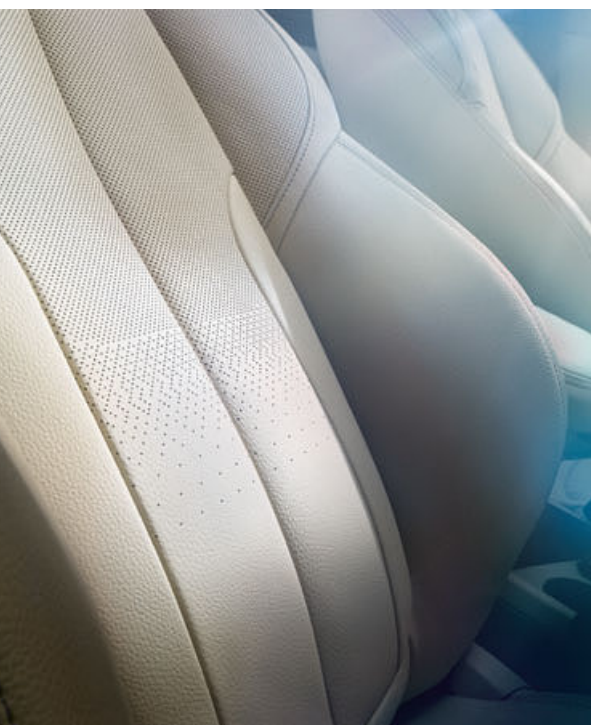

SE.

Interior equipment features:

- 40:20:40 electrically folding rear seats (Second row only)
- 60:40 sliding rear bench (Second row only)
- Automatic air-conditioning, with two-zone control
- Bluetooth hands-free facility with USB audio interface and Bluetooth audio streaming
- BMW Navigation System
- BMW Online Services
- BMW Professional radio with single CD player (with MP3 playback capability)
- DAB tuner
- Door sill finishers, front with BMW designation
- Extended lighting (Gran Tourer models only)
- Grid cloth upholstery
- Interior trim, Oxide Silver
- Power sockets (12V) in centre console and passenger footwell
- Sport multi-function leather steering wheel, with Speed limiting function
- Third row seating (Gran Tourer models only)

Exterior equipment features:

- 16" light alloy V-spoke style 471 wheels
- Active Guard, featuring forward vehicle collision warning
- Automatic tailgate
- Drive Performance Control with ECO PRO, Comfort and Sport modes
- Exhaust tailpipe finisher, Chrome
- Foglights, front
- Heated exterior mirrors and heated windscreen washer jets
- High-level third brake light
- Kidney grille, Chrome with Black vertical bars
- LED daytime driving lights
- Park Distance Control (PDC), rear
- Performance Control
- Rain sensor, with automatic headlight activation
- Roof rails, Black (Gran Tourer models only)
- Six-speed manual transmission



[01] The cockpit exudes style and sophistication with Oxide Silver interior trim and standard Sport multi-function leather steering wheel.

[03] Adding to the comfort factor are seats upholstered in Anthracite Grid cloth.

[02] 16" light alloy V-spoke style 471 wheels, 7J x 16 with 205/60 R16 tyres.

04 □



05 □



[04] The BMW Active Tourer in optional Mediterranean Blue metallic paint with optional 17" light alloy V-spoke style 479 wheels and the optional exterior trim in Chromeline.

[05] The BMW Gran Tourer in optional Imperial Blue Xirallic paint with standard 16" light alloy V-spoke style 471 wheels and Black roof rails.

SPORT.

■ Standard equipment □ Optional equipment

Interior equipment features:

- Contrast stitching on instrument panel in Red or Grey to match seat upholstery
- Door sill finishers with BMW designation, front
- Interior trim, High-gloss Black with Pearl Chrome finisher
- LED ambient lighting in door trim
- Race cloth upholstery
- Remote control with integrated key, with Silver highlight
- Sport seats, front

Exterior equipment features:

- 17" light alloy Star-spoke style 379 wheels
- Exhaust tailpipe finisher, Chrome
- Front air inlet with High-gloss Black finisher
- Kidney grille with 10 extra-wide High-gloss Black fronted vertical slats
- Rear bumper with High-gloss Black finisher

01 ■



03 ■



02 ■



04 □



[01] The ergonomic layout of the controls in the cockpit and overall design are characteristics of the BMW focus on the driver's well being.

[02] Standard 17" light alloy Star-spoke style 379 wheels, 7.5 J x 17 with 205/55 R 17 tyres.

[03] Sports seats upholstered in Race cloth shown here in Anthracite with Red highlight emphasise this model's sporty nature.

[04] Optional 17" light alloy Double-spoke style 385 wheels, 7.5 J x 17 with 205/55 R 17 tyres.

05 □



06 □



[05] The BMW Sport Active Tourer in optional Flamenco Red Xirallic paint with optional 18" light alloy Y-spoke style 484 wheels.

[06] The BMW Sport Gran Tourer in optional Mineral White metallic paint with standard 17" light alloy Star-spoke style 379 wheels and optional High-gloss Shadowline exterior trim.

LUXURY.

■ Standard equipment □ Optional equipment

Interior equipment features:

- Contrast stitching on instrument panel
- Dakota leather upholstery with perforation and Grey contrast stitching
- Door sill finishers with BMW designation, front
- Interior trim, Finline Stream wood with Pearl Chrome finisher
- LED ambient lighting in door trim
- Remote control with integrated key, with Silver highlight

Exterior equipment features:

- 17" light alloy Multi-spoke style 481 wheels
- Exhaust tailpipe finisher, Chrome
- Exterior trim, Chromeline
- Front air inlet with Chrome finisher
- Kidney grille with 12 Chrome fronted vertical slats
- Rear bumper with Chrome finisher

01 □



03 □



02 ■



04 □



[01] The light tones of the cockpit contrast with the optional Finline Shore wood interior trim with inlays and Pearl Chrome finisher to give a striking and sophisticated look.

[03] The optional Sport seats upholstered in Canberra Beige Dakota perforated leather with Grey stitching provide extra comfort in the interior.

[02] Standard 17" light alloy Multi-spoke 481 wheels, 7.5 J x 17 with 205/55 R 17 tyres.

[04] Optional 18" light alloy Y-spoke style 484 wheels, 8 J x 18 with 225/45 R 18 tyres.

05 □



06 □



[05] The BMW Luxury Active Tourer in optional Platinum Silver metallic paint with optional 18" light alloy V-spoke style 485 wheels.

[06] The BMW Luxury Gran Tourer in optional Atlantic Grey metallic paint, optional 18" light alloy V-spoke style 485 wheels and optional roof rails in Aluminium.

M SPORT.

■ Standard equipment □ Optional equipment

Interior equipment features:

- Ambient lighting – switchable
- Contrast stitching on instrument panel
- Dakota leather upholstery with perforation and contrast stitching
- Door sill finishers with M designation, front
- Gearshift lever with M designation, short-shift (Manual transmission only)
- Headlining, Anthracite
- Interior trim, Aluminium Hexagon with Pearl Chrome finisher
- M Sport multi-function leather steering wheel
- Remote control with integrated key, with M Sport highlight
- Sport seats, front

Exterior equipment features:

- 18" light alloy M Double-spoke style 486 M wheels
- Exhaust tailpipe finisher, Chrome
- Exhaust tailpipe finisher, Chrome – twin, round, left and right split (220i / 225i xDrive / 220d / 220d xDrive)
- Exterior trim, High-gloss Shadowline
- Kidney grille with extra-wide High-gloss Black vertical slats
- M aerodynamic bodystyling
- M logo designation, side – Chrome
- M Sport suspension

01 ■



02 ■



[01] The M Sport multi-function leather steering wheel shown here with gearshift paddles, with the Aluminium Hexagon interior trim with Pearl Chrome finisher lend the interior a distinctly sporty look.

[02] Headlining in Anthracite.

[03] Door sill finishers with M designation, front.

03 ■



04 □



05 ■



[04] 18" light alloy V-spoke style 485 wheels, 8J x 18 with 225/45 R18 tyres.

[05] 18" M light alloy Double-spoke style 486 M wheels, 8J x 18 with 225/45 R18 tyres.

06 □



07 □



[06] The BMW M Sport Active Tourer in optional Estoril Blue metallic paint which is exclusive to M Sport models.

[07] The BMW M Sport Gran Tourer with the optional exclusive Estoril Blue metallic paint and standard 18" M light alloy Double-spoke style 486 M wheels with run-flat tyres.

THE BMW 225xe iPERFORMANCE ACTIVE TOURER.

■ Standard equipment □ Optional equipment

The BMW 225xe iPerformance Active Tourer is equipped with the innovative BMW eDrive technology which combines the best of both worlds in a plug-in hybrid. On the one hand, when in pure electric driving mode it offers maximum driving pleasure with a minimum of noise, local emissions free driving (in urban areas, for example) and an excellent range. On the other, it delivers dynamic driving performance. Uniting both the BMW TwinPower Turbo three-cylinder petrol engine of 136hp (100kW) and an 88hp (65kW) output electric motor you benefit from low CO₂ emissions of 46–49g/km and an efficient combined fuel consumption of 141.2–134.5mpg (2.0–2.1l/100km). The electric motor can power the vehicle independently or support the engine, depending on the required power output and current battery level. During braking, the motor even transforms kinetic energy into electric energy, which is stored in the high-voltage battery for use by the electric drive system. The electric xDrive all-wheel-drive system provides optimised stability, increased agility in different weather and road conditions and reliable traction. At home, using a conventional household socket or an optional BMW i Wallbox you can ensure you are optimally prepared for every journey. Even when you are out and about with the ever increasing number of charging points and the pioneering BMW i ConnectedDrive Services, you can charge your BMW quickly and easily.

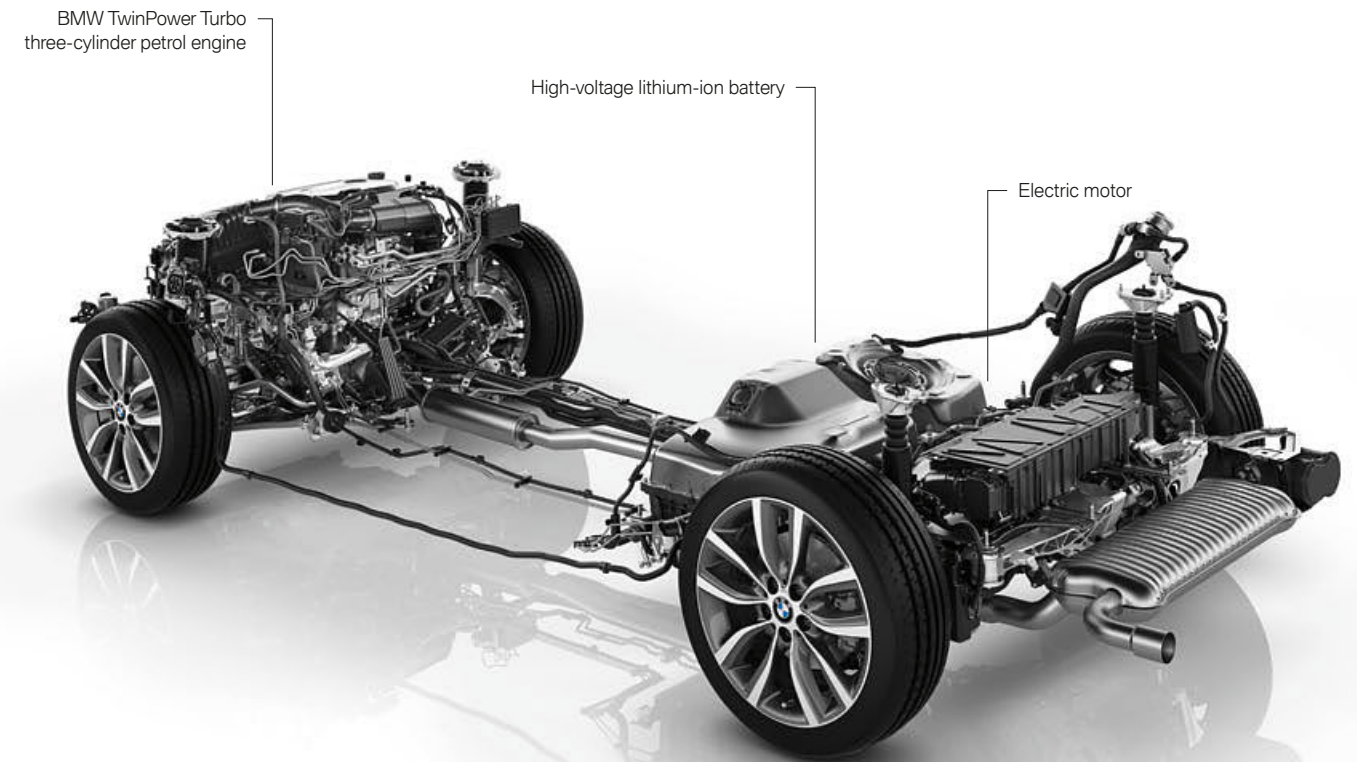

[01] The driver can choose from three electric drive modes by pressing the eDrive button: AUTO eDrive (standard), MAX eDrive or SAVE BATTERY.

[03] The charging port for the external charging of the high-voltage battery can be found behind a flap on the vehicle's front side panel on the left. The charging port is protected from harmful environmental effects by a special gasket ring.

[05] Luggage compartment with flat floor. The electric motor and all power electronics are discreetly hidden underneath. The rear seat backrest, which can be divided in a 40:20:40 split guarantees a high level of flexibility.

[02] The specialised instrument cluster includes dials that help the driver to make particularly efficient use of the electric drive. The eDrive designation in the instrument panel gives a foretaste of the vehicle's highly efficient drive concept.

[04] The BMW TwinPower Turbo three-cylinder petrol engine features agile power delivery, excellent responsiveness even at low rpms, awe-inspiring sound and high efficiency. In the plug-in hybrid it forms a powerful drive unit in conjunction with the electric motor.

[06] Unique, Blue-underlaid door sill finishers with eDrive lettering in the doors draws attention to the vehicle's highly efficient drive concept.

EQUIPMENT HIGHLIGHTS.

■ Standard equipment □ Optional equipment



01 □



04 □



05 ■



07 □



10 ■



02 □



06 □



03 □



08 ■



09 □



11 ■

[01] Adaptive LED Headlights including dipped and main beam, side and daytime driving lights also with turning light and automatic beam-throw control.

[04] Corona ring daytime driving lights create an unmistakable appearance with Adaptive LED headlights.

[06] Panoramic glass sunroof, electric, with slide and tilt function, headliner panel, wind deflector and remote opening/closing via car key.

[07] Steering wheel heating quickly warms up the rim of the steering wheel at the touch of a button.

[09] Eight-speed Sport automatic transmission with Steptronic enables dynamic and sporty gearshifts via the steering wheel paddles or selector lever.¹

[11] Performance Control lets the driver choose between standard Comfort mode, ECO PRO mode, geared towards efficiency, and Sport mode.

[02] High-gloss Shadowline exterior trim, includes front and rear side window trim and recess finishers, exterior mirror frame and base in High-gloss Black (Standard on M Sport models).

[05] Fog lights in the front air inlets along with heated exterior mirrors and windscreen washer jets provide better visibility and increase safety.

[03] Chromeline exterior trim with window strips finished in Chrome. (Standard on Luxury models).

[08] Sport multi-function leather steering wheel in Black with a thick rim and contoured thumb rests has an exceptionally pleasant, perfectly contoured feel (excluding M Sport models).

[10] M Sport multi-function leather steering wheel features Pearl Chrome highlights, more pronounced thumbrests and a thicker rim for better grips. (Standard for M Sport models)

[12] The electrically operated hand brake is conveniently activated via a button in the centre console.

¹ Standard on 220i, 225i xDrive Active Tourer and 220d xDrive.

EQUIPMENT HIGHLIGHTS.

■ Standard equipment □ Optional equipment



[01] Rear Park Distance Control (PDC) makes it easier to reverse and park the car in tight spaces.

[04] Park Assist makes parallel parking easier. Activated when the reverse gear is selected, it steers while the driver controls the accelerator and the brake.

[02] Driving Assistant Plus includes Approach and Lane Departure Warning and Active Cruise Control with Stop & Go function.

[05] Reversing Assist camera shows the area behind the car on the Control Display. Interactive track lines provide assistance when manoeuvring or parking.

[03] Head-up Display transmits driving-related information directly into the driver's line of vision.¹

[06] BMW Navigation Plus includes 8.8" widescreen display, iDrive Touch Controller, 8 programmable favourite buttons, route planning including ECO PRO route, multiple map views and 3D city models.

[07] Enhanced Bluetooth phone preparation with USB audio interface and Voice Control allows a mobile phone to be connected to the vehicle via Bluetooth. Snap-in adapter may be required (available from BMW Genuine Accessories).

[08] Loudspeaker system – harman/kardon with 360W digital amplifier, 12 speakers including centre speaker.

[09] Rear folding tray tables give added convenience to rear passengers (Standard on Gran Tourer models).

[10] The front passenger seat with foldable backrest is testament to the flexible and practical space concept.²

[11] Comfort access, provides keyless access and starting of the vehicle, also includes smart-opener allowing for contactless access to the rear tailgate.

[12] The adjustable rear seat allows even more versatile use of the luggage compartment. The seats can be adjusted to either increase leg room for the rear passengers or to maximise loading space in the luggage compartment, as required (not available on 225xe models).

[13] Remote electronic rear backrest release makes it easy to fold down the rear-seat backrest from the luggage compartment (Not available on the 225xe models).

[14] The automatic tailgate operation opens and closes at the touch of a button.

[15] The 40:20:40 split-folding rear seat bench with adjustable backrest make loading even easier, and the vehicle even more versatile.

¹ Image shows optional speed limit information.

² Not available in conjunction with Sport seats or seats with electric seat adjustment.

WHEELS AND TYRES.

■ Standard equipment □ Optional equipment



[01] 18" light alloy V-spoke style 485 wheels, 8 J x 18, 225/45 R 18 tyres.

[04] 18" light alloy Y-spoke style 484 wheels, 8 J x 18 with 225/45 R 18 tyres.

[08] 17" light alloy Y-spoke style 480 wheels, 7.5 J x 17 with 205/55 R 17 tyres.

[02] 17" light alloy Double-spoke style 385 wheels, 7.5 J x 17, with 205/55 R 17 tyres.

[05] 17" light alloy V-spoke style 479 wheels, 7.5 J x 17 with 205/55 R 17 tyres.

[09] 17" light alloy Star-spoke style 478 wheels, 7.5 J x 17 with 205/55 R 17 tyres.

[03] 16" light alloy V-spoke style 471 wheels, 7 J x 16 with 205/60 R 16 tyres (standard on SE models).

[06] 16" light alloy Double-spoke style 473 wheels, 7 J x 16 with 205/60 R 16 tyres.

[10] 16" light alloy Turbine-style 472 wheels, 7 J x 16 with 205/60 R 16 tyres.

[07] 17" light alloy Star-spoke style 379 wheels, 7.5 J x 17 with 205/55 R 17 tyres (standard for Sport models).

[11] 18" M light alloy Double-spoke style 486 M wheels, 8 J x 18 with 225/45 R 18 run-flat tyres (standard for M Sport models).

GENUINE BMW ACCESSORIES.

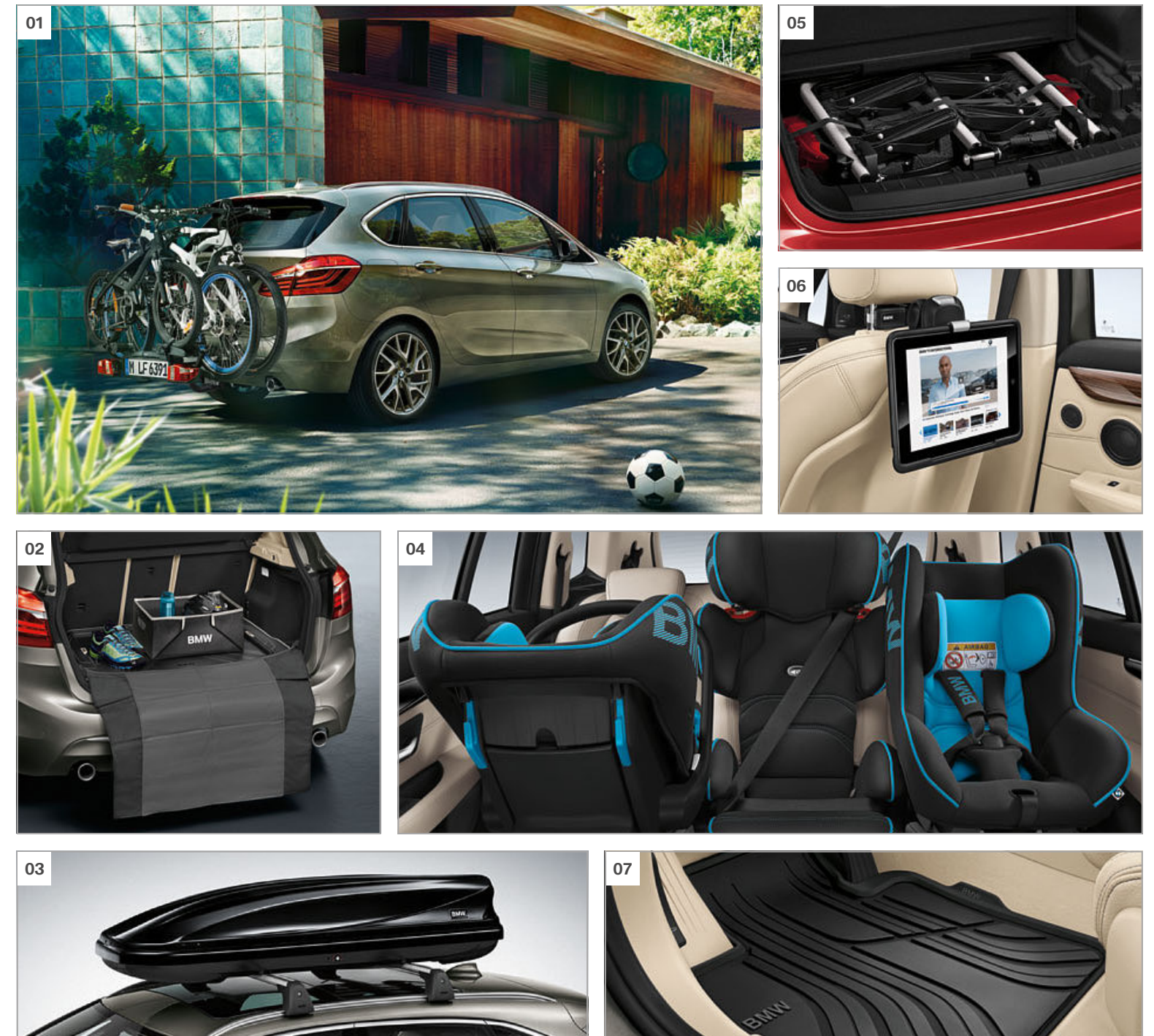

[01] Bicycle / e-bike holder for the transport of up to three bikes (max. 60 kg), extension for third bike available. Securely mounts to the trailer tow hitch. Tilting function for easy access to the luggage compartment.

[03] BMW roof box 320 for up to five pairs of skis. Compatible with all BMW roof rack systems. With double-sided opening system and triple locking on each side.

[05] Rear bike carrier – The Rear Bike Carrier Compact for the BMW 2 Series Active Tourer is an effective way to carry bikes. It is easy to operate and when not in use can fold down to a very small size and fit in the storage well underneath the luggage compartment floor.

[02] Luggage compartment mat to protect the luggage compartment from dirt and moisture. With raised border and two textile pockets. Available in Anthracite, Anthracite/red and Anthracite/beige (shown with folding box and loading sill mat).

[04] BMW child seats available in various models and colours (three BMW child seats can only be fitted in the second row of seating in the BMW 2 Series Gran Tourer).

[06] Travel & Comfort System – iPad holder. Snapped into the basic carrier and securely holds a range of Apple iPads™.

Discover the wide range of innovative solutions in the following categories: exterior, interior, communication & information as well as transport & luggage solutions. Your BMW Retailer will be happy to advise and provide you with a catalogue detailing the entire range of Genuine BMW Accessories. For more information visit www.bmw.co.uk/accessories

EXTERIOR COLOURS.

■ Standard equipment □ Optional equipment



■ **Non-metallic** 668 Jet Black¹



□ **Metallic** A83 Glacier Silver



□ **Metallic** B39 Mineral Grey



□ **Metallic** C10 Mediterranean Blue¹



□ **Metallic** B45 Estoril Blue²

M SPORT.



■ **Non-metallic** 300 Alpine White

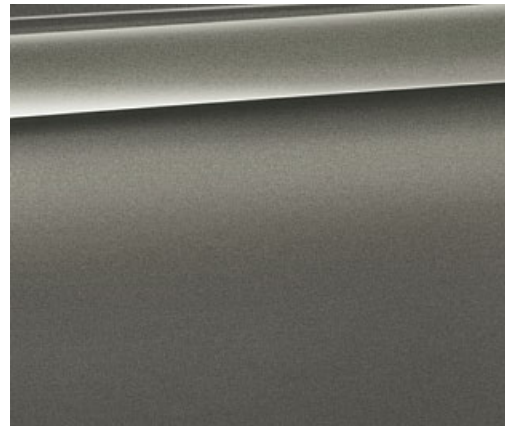

□ **Metallic** C08 Platinum Silver¹



□ **Metallic** C06 Flamenco Red Xirallic¹



□ **Metallic** A89 Imperial Blue Xirallic¹



□ **Metallic** A96 Mineral White



□ **Metallic** C09 Atlantic Grey¹



□ **Metallic** B53 Sparkling Brown¹



□ **Metallic** 475 Black Sapphire

¹ Not available with M Sport models.
² Exclusively available with M Sport models.

[Colour samples] These colour samples are intended as an initial guide to the colours and materials available for your BMW. However, experience has shown that printed versions of paint, upholstery and interior trim colours cannot in all cases faithfully reproduce the appearance of the original colour. Please discuss your preferred colour choices with your BMW Retailer. There you can also see original samples and be assisted with any requests.

INTERIOR COLOURS.



LEATHER

Available for



SE

Dakota leather
LCSW Black



SE

Dakota leather
LCCY Canberra Beige

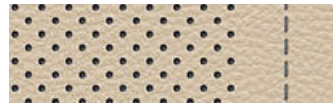

Sport
 Luxury
 M Sport

Dakota leather
PDCY Canberra Beige with perforation and Grey stitching



Sport
 Luxury
 M Sport

Dakota leather
PDSW Black with perforation and Grey stitching



Sport

Dakota leather
PDL3 Black/Red with perforation and Red stitching



M Sport

Dakota Leather
PDN4 Black with perforation and Blue highlight

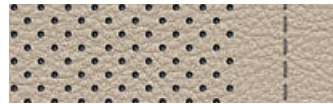

Sport
 Luxury
 M Sport

Dakota leather
PDOA Oyster/Grey with perforation and Grey stitching

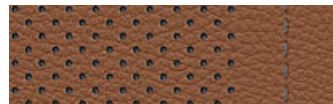

Sport
 Luxury
 M Sport

Dakota leather
PDD3 Saddle Brown with perforation and Grey stitching

CLOTH

Available for



SE

Grid Cloth
EGAT Anthracite¹

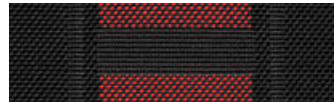

Sport

Race Cloth
ERL2 Anthracite with Red highlight



Sport

Race cloth
ERL1 Anthracite with Grey highlight

INTERIOR TRIMS

Available for



SE

4FS Oxide Silver with Black High-gloss finisher



SE
 Sport
 Luxury
 M Sport

4LS Brushed Aluminium with Pearl Chrome finisher



SE
 Sport
 Luxury
 M Sport

4LR Finition Stream wood with Pearl Chrome finisher



SE
 Sport
 Luxury
 M Sport

4LU Black High-gloss with Pearl Chrome finisher



Sport
 Luxury

4FZ Finition Tide wood with Pearl Chrome finisher



Luxury

4FY Finition Shore wood trim with inlays and Pearl Chrome finisher



M Sport

4WE Aluminium Hexagon with Pearl Chrome finisher

INTERIOR COLOURS

Available for



SE
 Sport
 Luxury
 M Sport

Black



SE
 Sport
 Luxury
 M Sport

Canberra Beige

HEADLININGS

Available for



SE
 Sport
 Luxury
 M Sport

Headlining
775 Anthracite

Please note that even normal long or short-term use can lead to unrecoverable upholstery damage. This can be caused in particular by non-colourfast clothing.

Please note that the interior colour depends on the selected upholstery colour.

¹ Not available with Sport seats.

THE BMW SERVICE CONCEPT:

When you buy a BMW, you can look forward to superb service and comprehensive customer care. **Condition Based Service** tracks service fluids and parts subject to wear, and where appropriate indicates required service stops on the display. In combination with **BMW TeleServices**, the vehicle data collected by Condition Based Service are automatically transmitted to BMW. Your preferred **BMW Service Retailer**

BMW SERVICE INCLUSIVE.



BMW Service Inclusive:

Wouldn't it be good to know your comprehensive servicing costs in advance? Well, that's exactly what BMW Service Inclusive¹ provides and for a low one-off payment.

BMW Service Inclusive¹ lasts for 5 years or 50,000 miles (whichever occurs first) and covers all your vehicle's comprehensive servicing requirements. Alternatively you can choose BMW Service Inclusive Plus¹ which in addition to servicing also covers maintenance items such as brake pads, brake discs and windscreen wipers. And whenever

servicing and maintenance work is carried out on your BMW, you can be sure that it will only be done by fully qualified BMW Service Approved Technicians at one of over 150 BMW Service Authorised Workshops around the country. Furthermore, only Genuine BMW Parts are used – each covered by a two year warranty. BMW Service Inclusive and Service Inclusive Plus are transferable to subsequent owners within the time and mileage period, which can enhance the resale value of your car.²

www.bmw.co.uk/serviceinclusive

BMW EMERGENCY SERVICE.



BMW Emergency Service. BMW Emergency Service is the only roadside and assistance programme designed specifically for BMW vehicles offering an exceptional range of benefits and services. It is available 24 hours a day, 7 days a week and utilises a dedicated fleet of BMW Approved Technicians, equipped with Genuine Parts and tools, ensuring that you and your vehicle receive the best possible care in the event of any motoring emergency.

This tailor-made programme has been specifically designed to meet the needs of BMW drivers travelling in the UK, Republic of Ireland and Continental Europe giving complete reassurance and peace of mind. Every new BMW is covered for three years.

THE BMW EXPERIENCE.



BMW News: To ensure you're one of the first to hear the latest BMW news and developments, BMW UK offer an email programme. Sign-up at: www.bmw.co.uk/newsletter



BMW World, an iconic building in the Munich skyline. The BMW World is a true brand experience where it's possible to marvel at the historic BMWs in the museum, learn about our engineers' newest innovations and take a tour of the plant to experience with your own eyes the cutting-edge and exacting methods used to create a BMW.



BMW Magazine: Every new BMW customer receives a complimentary subscription to BMW Magazine. This publication features all the latest news and developments from BMW, together with a variety of driving and lifestyle features.

can access the vehicle data. They will contact you when necessary to arrange a service appointment where the required repairs can be performed, using **Genuine BMW Parts**, so your driving pleasure can continue indefinitely. Worldwide, you can call on more than **3,300 Service Authorised Workshops** in more than **150 countries**.

BMW CONNECTED DRIVE SERVICES.



BMW ConnectedDrive Services.

A function using the built-in BMW SIM card to provide telematic and online services that are fully integrated into your BMW vehicle. All services require connection to a UK mobile network. Some services are available in other European countries. The range of ConnectedDrive Services that are available depends on the specification of the vehicle. The service duration varies depending on the ConnectedDrive Service.

For further information on BMW ConnectedDrive Services and terms and conditions please visit www.bmw.co.uk/connecteddrive-information

BMW FINANCIAL SERVICES.



BMW Financial Services: BMW Financial Services offers a range of finance and insurance solutions designed to help you drive the BMW of your choice. All our products offer you the flexibility to customise your finance, making driving any BMW a reality. After all, who knows more about financing your BMW than BMW.

For customers in the United Kingdom If you would like to find out more information, visit www.bmwfs.co.uk Here, you will also find details of our comprehensive range of products and current offers engineered for every eventuality. BMW (UK) Ltd is a credit broker and not a lender. Finance is subject to status and available to over 18s in the UK only. Guarantees and

indemnities may be required. Finance is provided by BMW Financial Services (GB) Limited, Summit ONE, Summit Avenue, Farnborough, Hampshire GU14 0FB.

For customers in Ireland If you would like to find out more information, visit <http://www.bmw.ie/en/topics/owners/for-owners/bmw-financial-services.html> Here, you will also find details of our comprehensive range of products and current offers engineered for every eventuality. Finance is subject to status and available to over 18s in the IE only. Guarantees and indemnities may be required. Finance is provided by BMW Financial Services (Ireland) Limited, Swift Square, Santry Demesne, Santry, D09 R802, Dublin, Ireland.

SHAPING THE FUTURE – RESPONSIBLY.

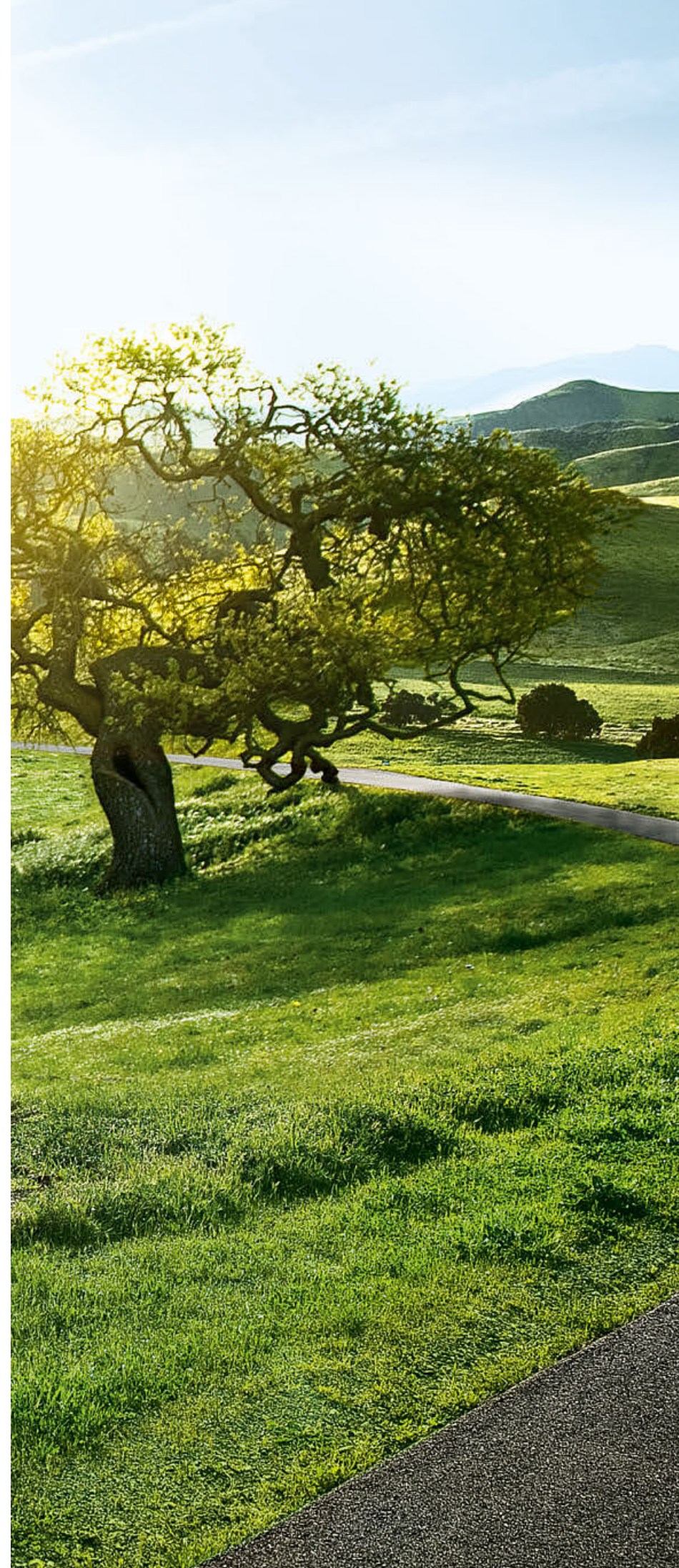

In 2015, the BMW Group was once again listed in the Dow Jones Sustainability World and Europe Indices and thus ranked one of the most sustainable automotive companies worldwide. The development of efficient vehicle concepts and eco-friendly production processes, up to and including recycling, is an integral part of our engineering philosophy. Thanks to BMW EfficientDynamics, the CO₂ emissions of our European new-vehicle fleet have dropped by more than 30% since 1995. Over the period from 2006 to 2020 we are also aiming to achieve a 45% reduction in the amount of resources – such as water and energy – that our manufacturing operations consume. Since 2007, production in our engine plant in Steyr, Austria, has generated zero waste water. And of course each of our vehicles is designed for easy and economical recycling after its long running life. Please contact your BMW Centre on all matters regarding your end-of-life vehicle. For further information please visit our website.

www.bmw.co.uk/EfficientDynamics
www.bmwgroup.com/responsibility
www.bmw.com/recycling

¹ Service Inclusive and Service Inclusive Plus are available as cost options. Terms and conditions apply, for full details speak to your retailer or visit www.bmw.co.uk/serviceinclusive

² For further information, please contact your local BMW Retailer.

More about BMW



The Ultimate
Driving Machine

www.bmw.co.uk
www.bmw.ie

The models illustrated in this Brochure show the specifications and configurations (standard and optional equipment) of vehicles produced by BMW AG for the German market. According to the specific requirements of other markets, alterations in standard and optional equipment and the configurations available for the different models, as described in this brochure, may occur. For more precise information about country-specific vehicle versions, please contact your local BMW Retailer. Subject to change in design and equipment. Part number 95 38 0 004 039. March 2016.

© BMW AG, Munich/Germany. Not to be reproduced wholly or in part without written permission of BMW AG, Munich.

4 11 002 091 21 1 2016 BB. Printed in Germany 2016.

