

Driving innovation.

IONIQ hybrid



I see
a changing world.

Moving in a new direction

When I look at my IONIQ hybrid, I see the future of mobility and the chance to make a difference. IONIQ hybrid is my choice mainly because of its amazing style and low CO₂ emissions: just 79g/km. So, I am making a difference and helping create a cleaner, better world. What's more, driving IONIQ is pure fun.





The future is here.

I really admire the elegance and simplicity of my IONIQ. It looks futuristic and inside, it's brimming with innovative features. IONIQ slices through the wind like no other car aided by its low coefficient of drag that allows me to enjoy a whisper quiet ride and great fuel efficiency.

Aerodynamic Cd **0.24**

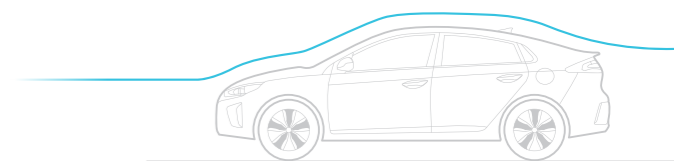

Radiator grille

The signature hexagonal grille features computer-controlled flaps that close automatically to improve aerodynamics.



LED rear combination lamps

Stylish lamps feature LED technology to deliver maximum illumination while drawing a minimal amount of electricity.



Rear bumper

Two-tone bumper has a graphic insert to add a sporty touch and provide continuity with the front end design.



The GLS model with optional equipment is shown here.

Feel that emotional connection.

IONIQ's interior is a masterpiece of emotional design: elegantly simple and pleasant to the touch but packed with innovative features such as wireless phone charging. The D-cut steering wheel provides a sporty look but also makes for easier entry and egress.

Supervision cluster with 7" color LCD

The impressive 7" supervision gauge cluster features a high resolution TFT LCD that is colorful, clear and easy-to-read.



Wireless charging

New induction technology lets me recharge my smartphone without connecting cables (compatible models only). And an alert is triggered should I ever leave my phone behind.



Center console

The brilliant layout and packaging of the console keeps me well organized. There's enough space for my tablet, smartphone and all kinds of other travel essentials.



D-cut steering wheel

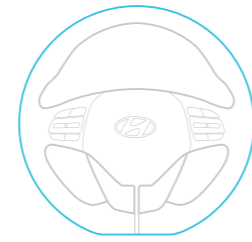



Dual clutch transmission (DCT)



IONIQ is equipped with a dual clutch transmission that puts the fun into driving. In sports mode, the DCT lets me shift as much as I like. At anytime, I can just switch to automatic mode and enjoy a more relaxing drive. Either way, gear changes are lightning fast. And manual mode gives me sporty performance without the bother of a foot clutch. IONIQ really does put excitement into hybrid driving.

Intuitive gear shift lever

This handy feature gives me a choice of ECO/Sport with manual. All it takes is a gentle flick of the wrist to change the drive mode setting. And the palm of my hand falls naturally atop the shift lever for effortless gear selection.



Aluminum hood and liftgate

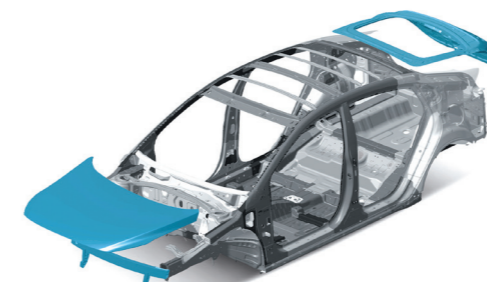

In order to attain the best possible fuel efficiency, IONIQ was put on a diet: IONIQ's hood and liftgate are fabricated from weight-saving aluminum instead of traditional steel. Hot stamping, high-tech adhesives and other innovative manufacturing methods were adopted to reinforce safety critical structures.

7-airbag system

My passengers & I enjoy complete protection thanks to 7-airbags: a pair of front airbags for my front passenger & I plus an airbag for my knees. A pair of side airbags (front only) and full-length curtain airbags defend against side collisions.





Kappa 1.6L Atkinson-cycle GDi engine

The best of both worlds.

Under IONIQ's hood two hearts beat as one: a 32kW electric motor and a Kappa 1.6-liter Atkinson GDi engine. IONIQ switches seamlessly between the conventional engine and electric motor. Gasoline direct injection extracts the maximum amount of energy from each droplet of fuel while delivering 105PS.



Advanced high-strength steels

The usage of advanced high-strength steel alloys has been expanded to 53 percent of the body structure. To attain unprecedented levels of structural rigidity, critical components were fabricated using advanced hot stamping technology.

Low center of gravity

By mounting the battery under the seats, IONIQ is able to attain an exceptionally low center of gravity. This greatly enhances agility and helps make IONIQ so much fun to drive.

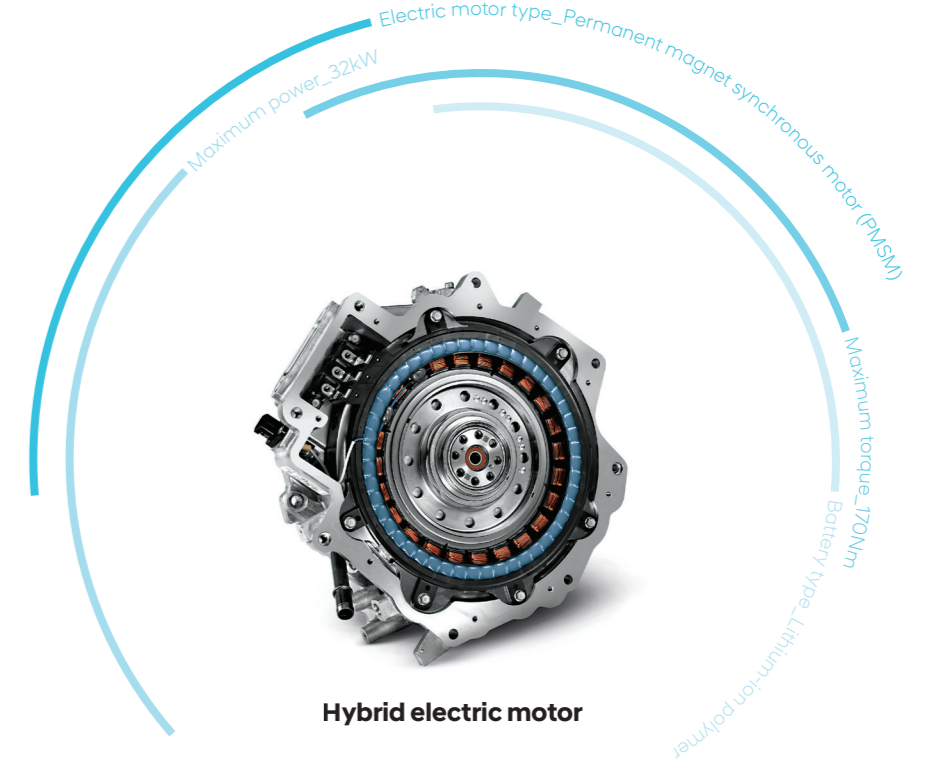
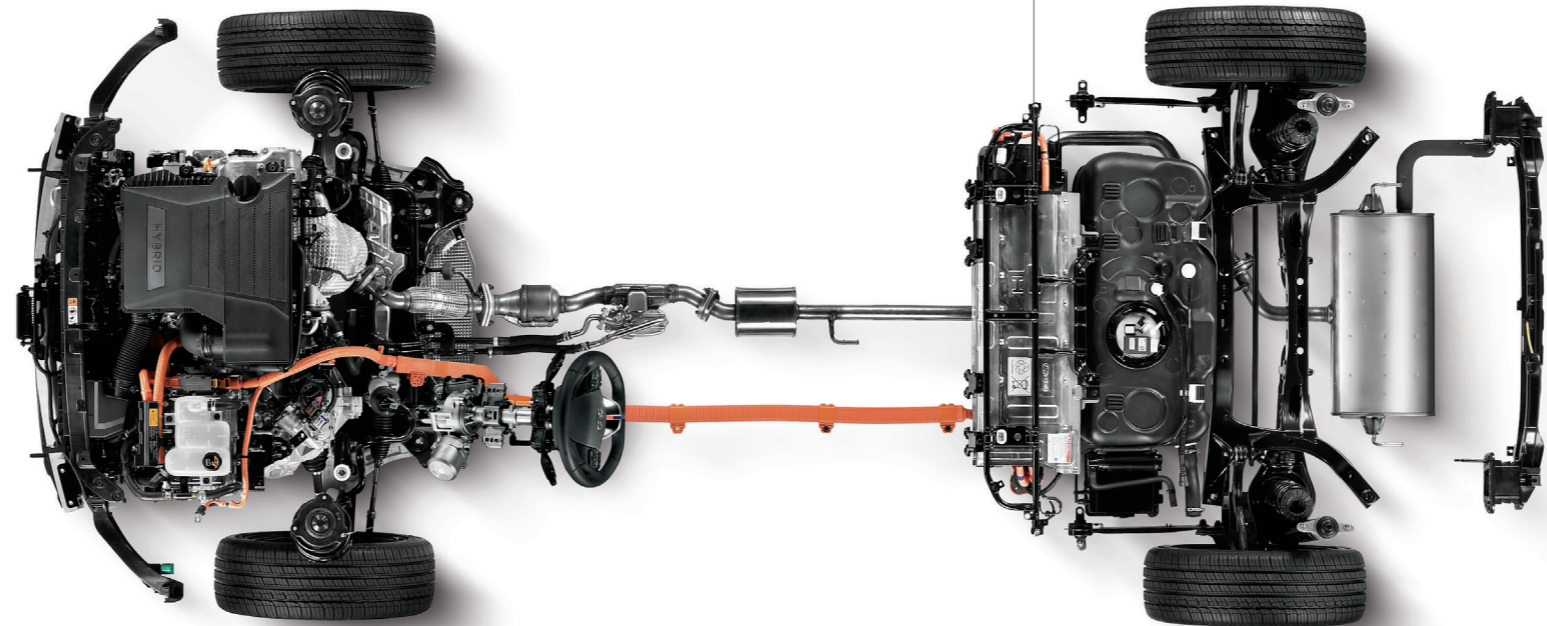

Hybrid electric motor

Predictive energy management

The highly advanced battery management system collects and analyzes data on your travel routes, driving style and habits for optimal energy storage. Advanced algorithms are employed to switch seamlessly between electric and gasoline propulsion modes and recover braking energy to recharge the batteries.

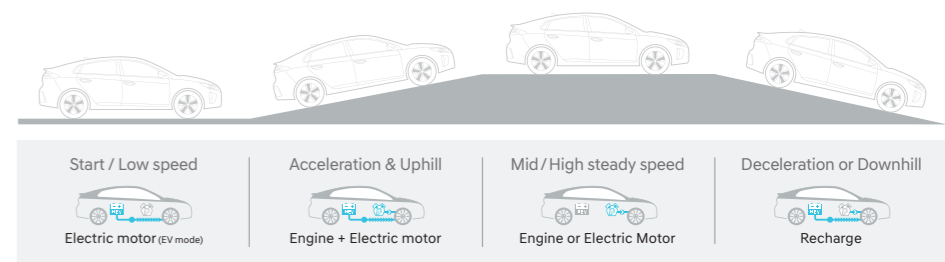



Packages



HID headlamps



Puddle lamps
Chrome door scuffs



Safety window controls



Power sunroof
Chrome-coated door handles

The GLS model with optional equipment is shown here.



Premium sound system



8.0" color navigation system
Front ventilated seats



Seat folding system (6:4 type)



Front & rear seat warmers
Power driver's seat

Exterior colors



Polar white (WAW)



Platinum silver (T8S)



Aurora silver (TS7)



Phantom black (NKA)



Iron gray (YT3)



Demitasse brown (RB4)



Marina blue (N4B)



Phoenix orange (RY9)

Interior colors

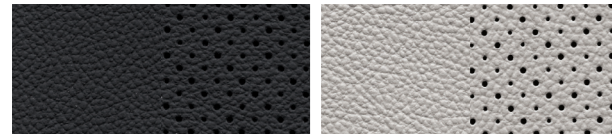

Leather

Leather

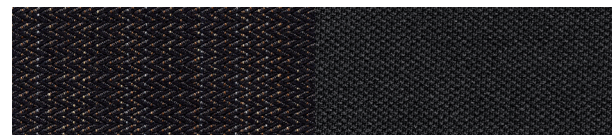

Woven

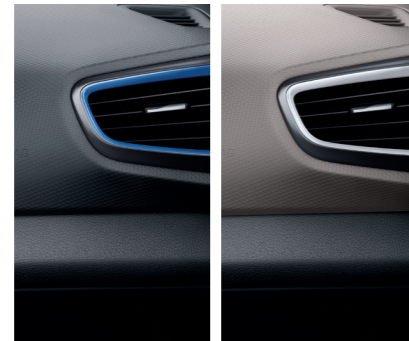

Wheels



15" alloy wheels



17" alloy wheels

Specifications

ENGINE

Type	GDi gasoline engine
Displacement (cc)	1,580
Max. power (PS / rpm)	105 / 5,700
Max. torque (kg-m / rpm)	15.0 / 4,000

ELECTRIC MOTOR

Type	Permanent magnet synchronous motor (PMSM)
Max. power (kW)	32
Max. torque (Nm)	170
Battery type	Lithium-ion polymer

DIMENSIONS

Head room (mm)	Front / rear (w/o sunroof)	994 / 950
Leg room (mm)	Front / rear	1,073 / 906
Shoulder room (mm)	Front / rear	1,425 / 1,396
Luggage capacity (liter)	Up to roof	550
	Rear seats down, up to roof	1,505

- The above values are results from internal testing and are subject to change after validation.
- Some of the equipment illustrated or described in this catalog may not be supplied as standard equipment and may be available at extra cost.
- Hyundai Motor Company reserves the right to change specifications and equipment without prior notice.
- The color plates shown may vary slightly from the actual colors due to the limitations of the printing process.
- Please consult your dealer for full information and availability on colors and trims.



Overall width 1,820
Wheel tread* 1,549



Overall length 4,470
Wheel base 2,700

Overall height
1,450



Wheel tread* 1,563

*Wheel tread : 15" (front/rear) - 1,563/1,577

Unit : mm

**Hyundai Motor Company**

<http://worldwide.hyundai.com>

EU. LHD GLS 1606 ENG. WD

Copyright © 2016 Hyundai Motor Company. All Rights Reserved.

People's expectation toward individual mobility requires more than just a convenient means of transportation. The old understanding of cars has become outdated. A car represents individuals' lifestyles, and it became an integral part of their lives. At the same time, the automobile industry has experienced seismic change. Hyundai Motor Company has grown rapidly to become one of the largest automakers, backed by world class production capability and superior quality. We have now reached a point where we need a qualitative approach to bring bigger ideas and relevant solutions to our customers. This is an opportunity to move forward and we have developed a new brand slogan that encapsulates our willingness to take a big leap. Led by our new slogan and the new thinking underlying it, we will become a company that keeps challenging itself to unlock new possibilities for people and the planet.