



A7

Audi A7 Sportback
■ Audi S7 Sportback

Audi
Vorsprung durch Technik 



| | Page | |
|--------------------|--|---|
| Fascination | | |
| | 4 Audi A7 Sportback | 24 Audi S7 Sportback |
| Technology | | |
| | 38 Audi ultra | 50 MMI® – Multi Media Interface |
| | 40 FSI®/TFSI® | 52 Audi connect |
| | 42 TDI® | 54 Assistance systems |
| | 44 quattro®/quattro® with sport differential | 56 Audi pre sense |
| | 46 Audi drive select | 58 Night vision assistant/head-up display |
| | 48 adaptive air suspension | 60 LED headlights |
| Equipment | | |
| | 64 Audi exclusive | 84 Lights and mirrors |
| | 66 S line | 85 Exterior equipment |
| | 70 Style guides | 87 Interior equipment |
| | 72 Paint finishes | 91 Infotainment |
| | 74 Wheels/tyres | 95 Assistance systems |
| | 76 Seats/seat upholstery | 97 Technology |
| | 81 Headlinings | 99 Audi Extended Warranty |
| | 82 Inlays | |
| Other | | |
| | 100 Audi Genuine Accessories | 110 Index |
| | 104 Technical data | 118 The fascination of Audi |
| | 108 Dimensions | |

Dialogue: Audi QR codes

Experience Audi even more directly: download a QR app to your smartphone and scan the QR code or use the given link provided in your browser.



The equipment for the vehicles illustrated in the Fascination section can be found on page 116. The fuel consumption and CO₂ emission figures can be found from page 104 onwards.

Nothing is more inspiring than a blank sheet of paper.

A line appears, it takes shape, which is then filled with life.
A vision becomes tangible – real. Space. Lightness.
Fascination. A unique car comes into being.

The Audi A7 Sportback. A unique vehicle class. It unites the pure grace of a Saloon, the clear functionality of an Avant and the passionate dynamism of a Coupé. Put together, a class of its own.
The Audi A7 Sportback.



Nothing is more inspiring than the view ahead.

Pure form, clear lines.
The Audi A7 Sportback exudes enthusiasm.

Above the defined wheel arches, a strikingly sharp dynamic line stretches across the whole length of the vehicle. It lends a unique excitement to the Audi A7 Sportback.

The perfect balance of puristic lightness and flowing lines creates a statement of dynamism and elegance.

The fuel consumption and CO₂ emission figures can be found from page 104 onwards.

A7

Audi A7 Sportback



Emotion meets functionality. A car for every day.
A car for special moments.

The muscular rear rounds off the Audi A7 Sportback. The striking trailing edge interacts harmoniously with the spoiler edge. The innovative vehicle concept with its wide-opening tailgate in coupé-like style is impressive not just because of its unusual design, but because it offers up to 1,390 litres of luggage space.

The fuel consumption and CO₂ emission figures can be found from page 104 onwards.



Nothing is more inspiring than the feeling that you have done everything right.

V-shaped lines define the bonnet, under which the powerful engine is waiting. A confident appearance.

The Audi Singleframe is fitted with high-quality, horizontal chrome struts and gives an impression of progressiveness and elegance. Its novel interpretation gives the headlights a more exciting, powerful look.



Attractive aluminium wheels create individual highlights.

The LED daytime running lights of the headlights ensure powerful illumination and their 18 single diodes shine with dynamic elegance.

The distinctively designed exterior mirrors fit in harmoniously with the dynamic overall look.

The streamlined LED rear lights confidently emphasise the breadth of the vehicle.



Nothing is more inspiring than a moment of silence.

Another feature of the Audi A7 Sportback is: consistency. The elegant exterior design blends seamlessly into the high-quality interior.

The interior concept of the Audi A7 Sportback embraces both driver and front passenger and gives them a feeling of security: the cockpit is designed with the driver in mind while the centre console leans towards the driver. Attractive inlays with continuous lines accentuate the interior. These can be provided in wood on request.

Technology which supports the driver. With the innovative, touch-sensitive MMI touch®, available on request, you can operate the navigation system, control media playback and make calls – all with just one finger and without taking your eyes off the road.





The comfortable seats are covered with high-quality material and provide very good support. On request, the Audi A7 Sportback can be fitted with comfort seats in leather including memory function which, depending on the version, have seat heating, seat ventilation and massage function with adjustable intensities.

Plenty of space for relaxation and a pleasant journey. The centre armrest can be folded up and ample storage spaces may be found in the frameless doors. The rear seats can be easily split and folded down to make the seating and luggage storage even more flexible.

The generous luggage space amounts to 1,390 litres with the rear bench seat folded down. The large, wide-opening tailgate can be opened and closed electrically.



Nothing is more inspiring than the start of a journey.

The Audi A7 Sportback has powerful yet efficient FSI/TFSI and TDI engines.

The optional quattro permanent all-wheel drive delivers this power to the road superbly. quattro with sport differential (optional) distributes the drive force variably to the individual wheels, giving you more driving dynamics, agility and traction.

At the rear, an eye-catching feature ensures greater downforce and sportiness: the harmoniously integrated rear spoiler extends automatically above 130 km/h or manually at the push of a button.

The fuel consumption and CO₂ emission figures can be found from page 104 onwards.



Sportiness which cannot just be seen, but above all experienced. The Audi A7 Sportback does not just impress with its dynamism, but also with its efficiency.

Intelligent lightweight construction leads to reduced vehicle weight and improved fuel consumption. The driver information system has an efficiency program which gives direct advice on how to drive in a more fuel-efficient manner. The start-stop system switches the engine off automatically when the car is at a standstill. And of course, the engines have been developed to use as little fuel as possible.

Nothing is more inspiring than a blank sheet of paper. A car came into being on one: contemporary, fascinating, unique. The Audi A7 Sportback.

The fuel consumption and CO₂ emission figures can be found from page 104 onwards.







Design that fascinates. Power that impresses.

A fascinating sight: the Audi S7 Sportback. An exciting experience: driving it. Feel its eight cylinders and its 309 kW. Enjoy its contemporary sportiness with generous comfort. Let your eyes wander over the drawn-out bonnet to the optional LED headlights and further to the front bumper and the powerful sills. The tornado line defines the dynamic characteristic over the entire length.

The fuel consumption and CO₂ emission figures can be found on page 106.

S7

Audi S7 Sportback



Top sporting performance. From our engineers.

A slight press on the accelerator and irresistible acceleration awaits you. Not without reason: the 4.0 TFSI engine's powerful eight cylinders take the S7 Sportback from 0 to 100 km/h in 4.7 seconds. You continue to accelerate. The 7-speed S tronic changes the gears in fractions of a second. Additional top-level driving dynamics are ensured by the quattro permanent all-wheel drive, optionally with sport differential, that provides the Audi S7 Sportback with a high level of traction on almost any surface.

The fuel consumption and CO₂ emission figures can be found on page 106.

Let every journey give you fresh inspiration. With Audi drive select it couldn't be simpler. Choose from five modes to make the ride sportier or more comfortable, as you wish. Or more efficient: efficiency mode helps to optimise the vehicle's energy consumption.

The fuel consumption and CO₂ emission figures can be found on page 106.





The Audi S emblem is the finishing touch for the characteristic Singleframe with horizontal double chrome struts. The black painted brake callipers are clearly visible through the spokes of the optional 20-inch cast aluminium wheels in S-specific design.



Concentrated fascination.

The interior's stylish ambience is made all the more attractive by particularly elegant details. The seats are optionally covered with sophisticated Valcona leather. Feel the special lateral support of the S sport seats – not only for the driver and front passenger, but also for the rear passengers.



Not only can you see the interior's breathtaking atmosphere, you can actually feel it: inlays shine in carbon Atlas on request, the leather-covered multifunction sport steering wheel bears the S emblem and is equipped with aluminium shift paddles on the right and the left. In addition, the optional touch pad ensures intuitive and even easier operation of navigation, media playback or comfort functions – a touch of the finger is all it takes. The selector lever knob offers good grip and is decorated with an aluminium clasp. Aluminium-look pedals round off the sporty appearance.



One last glance at the S7 Sportback: the two oval dual-branch tailpipes on both right and left catch your eye. The rear bumpers and the diffuser in platinum grey with a metal-look blade round off the sporty, high-quality overall appearance. No matter where the road takes you – it will be a sensational journey.

The fuel consumption and CO₂ emission figures can be found on page 106.



Audi ultra on the podium: the Audi R18 ultra

Audi ultra:

Every gram less extends the lead.

Audi ultra, the pioneering lightweight technology from Audi, is more than just the sum of its individual components. It combines innovative materials, intelligent design principles and production processes that use resources sparingly into an overall concept. Many Audi ultra lightweight measures have already been implemented in the Audi A7 Sportback and S7 Sportback.

That starts with the body itself. The aluminium hybrid body combines low weight with high

rigidity. And this despite the fact that the body is made by means of a steel/aluminium-mix construction method. This results in a high level of safety and an agile driving experience at the same time – as well as lower fuel consumption.

Innovative drive technologies such as direct fuel injection and turbocharging have made Audi engines more and more powerful. The modern TDI and TFSI engines in the Audi A7 Sportback and S7 Sportback produce more power from less displacement, making them significantly lighter

than the corresponding engines used in earlier model series.

Each lightweight component has an effect on other components, allowing their dimensions to be reduced as well. The result is a continuous development process towards less and less weight and more and more efficiency. In figures: a vehicle that weighs 100 kg less can save up to 0.3 litres of fuel per 100 km.

About weight reduction

The demands placed on modern vehicles are contradictory. On the one hand, they must offer enhanced performance and comfort, on the other they need to be more economical and efficient. Audi ultra resolves this conflict by examining each and every component. We demand the highest functionality combined with the lowest possible weight. The result is an intelligent mix of materials that even allows a reduction in engine size: lighter vehicles no longer need a large engine to be agile. Thus in 2011, for instance, the Audi R18 TDI drove to podium finishes at Le Mans with a V6 engine, whereas their victorious predecessor in 2010, the R15 TDI, had featured a V10 engine.

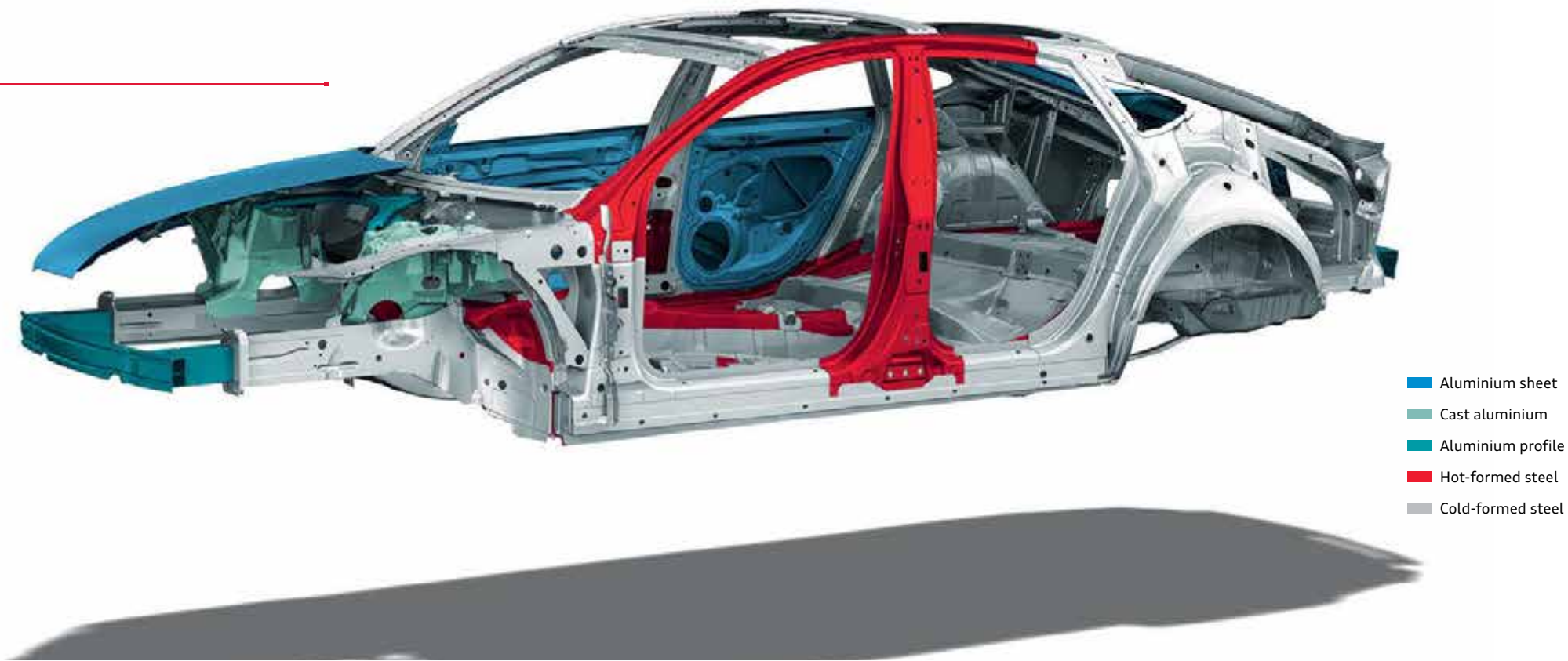

- Aluminium sheet
- Cast aluminium
- Aluminium profile
- Hot-formed steel
- Cold-formed steel

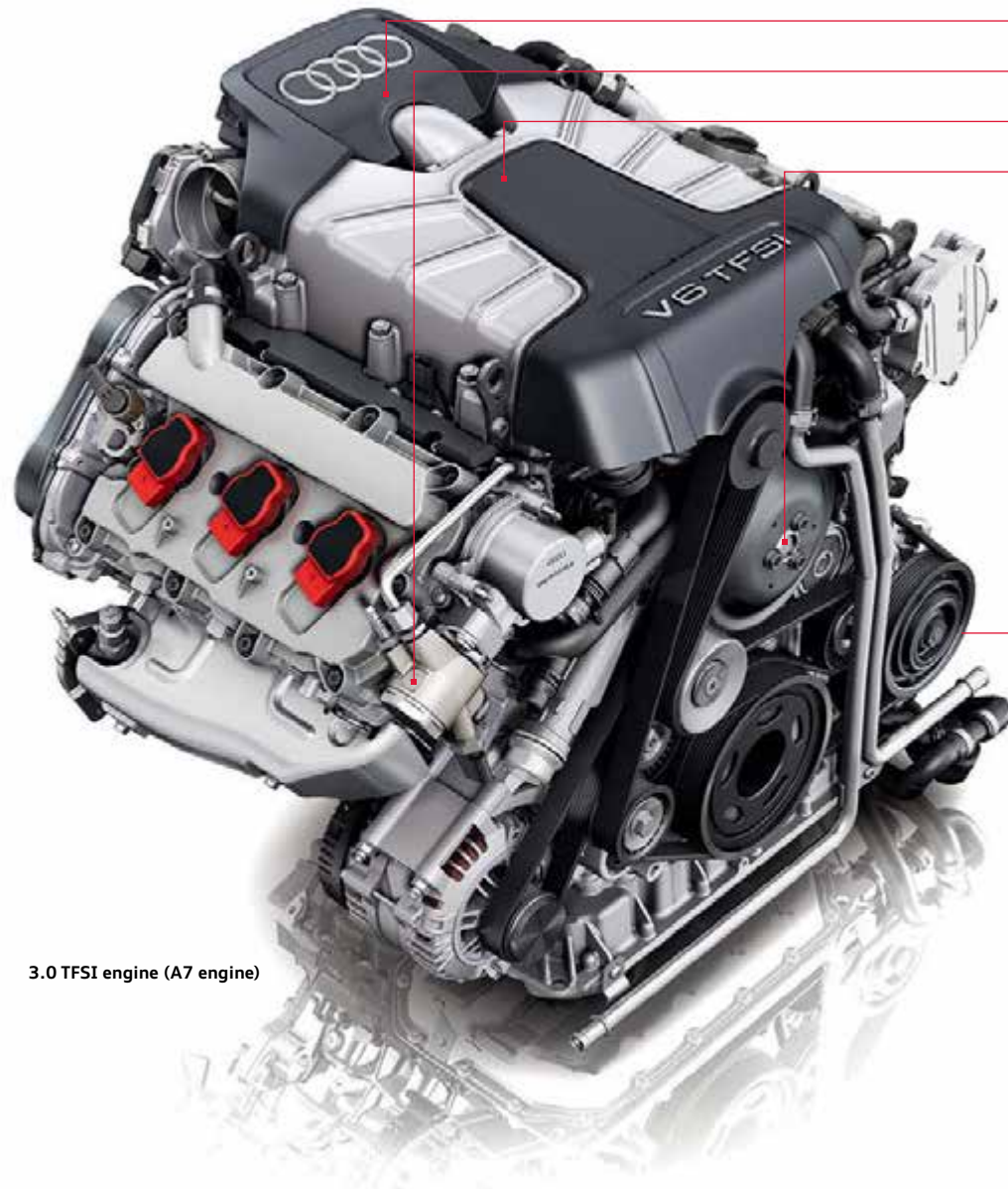

3.0 TFSI engine (A7 engine)

- timing chain
- high-pressure pump
- integrated supercharger
- switchable water pump

Many hours of development time.
Thousands of miles of testing.
And for what reason?

- inlet duct with switchable flaps
- air/water intercooler
- twin-scroll bi-turbocharger
- Audi cylinder on demand
- switch valve in coolant circuit for thermal management
- generator with recuperation

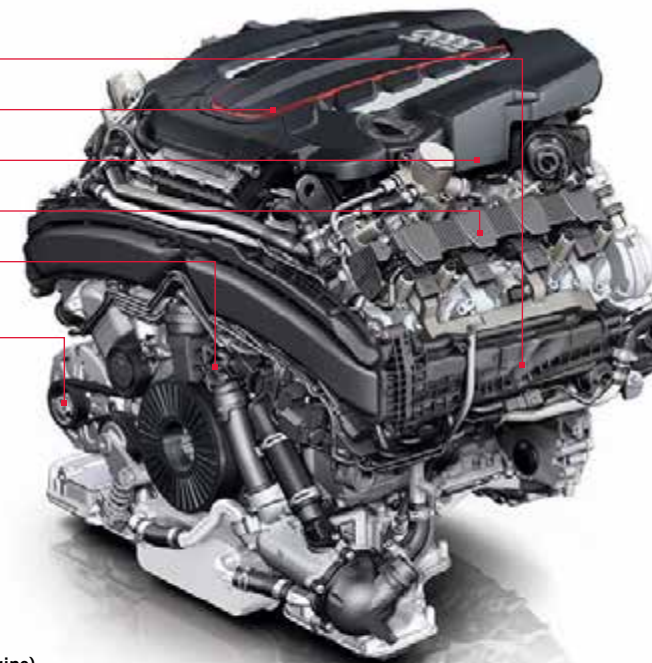

4.0 TFSI engine (S7 engine)



Audi cylinder on demand in the TFSI engine. If the V8 4.0 TFSI engine of the Audi S7 Sportback does not need the full power of 8 cylinders in the partial-load operational range, Audi cylinder on demand closes the intake and outlet valves of 4 cylinders – 2 each per cylinder bank – and their ignition and fuel injection are switched off. This means that neither is air taken in or fuel injected nor is exhaust gas emitted. The system will only kick in under certain conditions: when revs are between 960 and 3,500 rpm, the speed is at least 25 km/h and you are travelling in at least third gear of the 7-gear S tronic.

In just a few seconds you will understand why.

Among other things, TFSI technology is employed in the Audi A7 Sportback. Its unique feature is that it combines the advantages of FSI with a supercharging system, which ensures even better power delivery.

The 3.0 TFSI quattro generates a hefty 228 kW of power. An innovative mechanical supercharging system with intercooler is employed here and turns the 6-cylinder engine into a compact powerhouse with moderate fuel consumption. It is not just the peak torque of 440 Nm that is impressive, there is also the torque curve: with at least 90 % of the maximum torque being available across an engine speed range of 2,900

The fuel consumption and CO₂ emission figures can be found from page 104 onwards.

to 4,500 rpm. Thanks to its very spontaneous responsiveness and exceptional power delivery across the entire engine speed range, the 6-cylinder engine promotes a particularly dynamic driving style. The Audi A7 Sportback accelerates to 100 km/h in 5.6 seconds – and still has plenty of power reserves left after that.

The Audi S7 Sportback has a V8 4.0 TFSI engine that features the new innovative Audi cylinder on demand. This ensures that during partial load operation, only four of the eight cylinders are used – without you noticing the difference. The engine runs just as smoothly and powerfully, but using less fuel and emitting less CO₂. Thanks

to its very spontaneous responsiveness and exceptional power delivery across the entire engine speed range, the 8-cylinder engine promotes a sporty superior driving style. Its 309 kW accelerate the S7 Sportback at a torque of 550 Nm from 0 to 100 km/h in 4.7 seconds. The top speed is electronically regulated at 250 km/h.

The 2.8 FSI with 150 kW and Audi valvelift system (AVS) completes the engine options for the Audi A7 Sportback. The variable valve control system of the AVS helps to reduce fuel consumption.

In conjunction with the 7-speed S tronic® dual-clutch transmission and quattro permanent all-wheel drive, the 2.8 FSI accelerates from 0 to 100 km/h in just 8.3 seconds.

All FSI and TFSI engines in the Audi A7 Sportback and S7 Sportback comply with the EU5 emission standard.



The piezo injectors open and close in fractions of a millisecond and inject fuel several times into the combustion chamber at pressures of up to 1,800 bar. In some cases, an injection process can involve the injection of the tiniest of amounts weighing less than a thousandth of a gram.



Pre-injection results in a "gentle" combustion process and consequently excellent combustion acoustics and agreeable engine running characteristics.

TDI®

In other words: Where is the tank?

One in every two Audi cars sold today is a diesel. What sounds perfectly normal now was cause for huge excitement 20 years ago, when Audi revolutionised the market with the first 2.5 litre TDI engine. Since then, developments such as common rail technology have made TDI even more efficient. Piezo injectors ensure the fuel is finely and precisely distributed. Consequently, since the first TDI, the engines have become more economical, whilst specific output has increased. So it was only logical that a diesel car should then enter the world of motorsport. And

successfully too: in 2006, Audi was the first car maker to win the 24 Hours of Le Mans with a diesel-powered race car, the Audi R10 TDI – a victory which it has repeated several times over.

Powerful TDI engines in three power outputs are available for the Audi A7 Sportback, which of course feature intelligent common rail diesel technology. With a hefty 580 Nm of torque, the 180 kW 3.0 TDI quattro accelerates your A7 Sportback from 0 to 100 km/h in 6.3 seconds, the 230 kW 3.0 TDI quattro in just 5.3 seconds.

And the 150 kW 3.0 TDI, with an extremely low consumption of 5.1 l and CO₂ emissions of just 135 g, proves that efficiency does not prevent driving pleasure.

The 3.0 TDI with 180 kW is also available as a clean diesel version with quattro and S tronic dual-clutch transmission. This engine uses technology which specifically reduces nitrogen oxides. In this version it complies with the EU6 emission standard.

The fuel consumption and CO₂ emission figures can be found from page 104 onwards.

- turbocharger with optimised adjustable turbine geometry
- 1,800 bar high-pressure injection system
- friction-reduced engine
- pressure-regulated oil pump
- innovative thermal management with separate cooling system for engine block/cylinder head

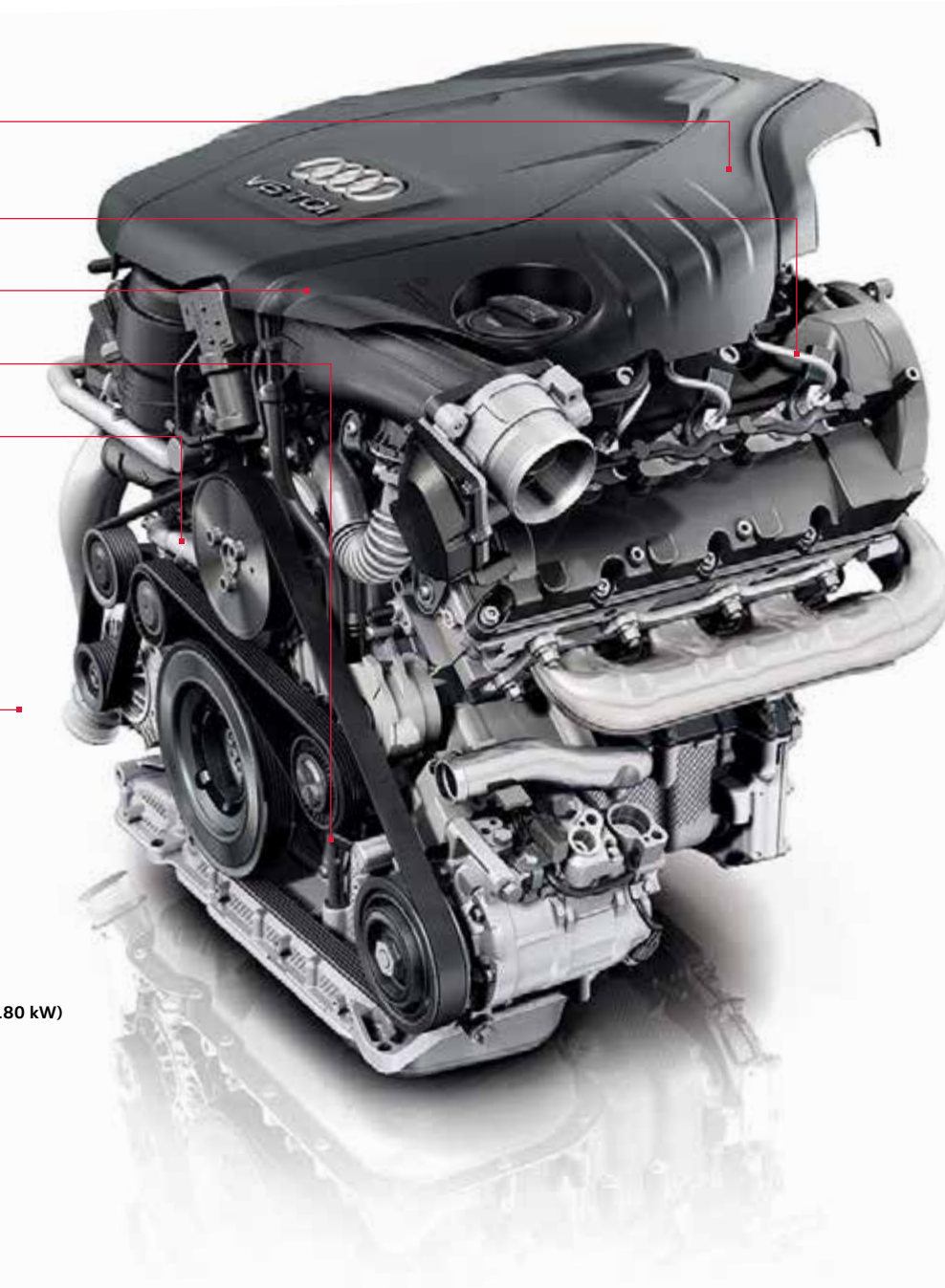

3.0 TDI engine (180 kW)

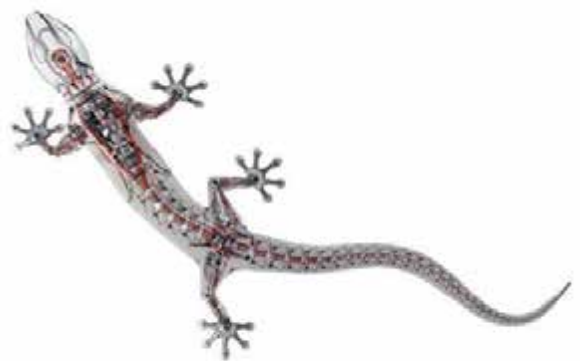

Why only use two wheels when a car has four?

The quattro® permanent all-wheel drive.

quattro is a permanent all-wheel drive system. If the wheels on one axle of the vehicle lose grip on the road and threaten to spin, then the drive force is transferred to the other axle – automatically and permanently distributed through the centre differential. The basic distribution is 40:60 – 40% of the power comes from the front axle, 60% from the rear. The benefit is better traction during acceleration and improved safety due to exceptional grip. So much for the technology. But what makes quattro unique is really the driving feel. “As if you are

stuck to the road,” some customers say. We put it like this: quattro gives you a better feel for the road and thus more safety.

The optional quattro with sport differential further reinforces this unmistakable quattro feeling. Vehicles tend to experience understeer when steering or driving into corners. This is a normal physical process: a moving object opposes a change in direction. The elastic tyres and the suspension mounts tense up until the new direction has been adopted. When accelerating

into a corner, the load on the front axle is reduced and it therefore transfers less lateral force to the tyres – the vehicle understeers. With the sport differential on the rear axle, the tendency has been significantly counteracted. This is because the quattro rear axle differential has been extended left and right by a clutch system with two gear levels. They ensure that the individual wheels on the rear axle receive different levels of torque. The clutches are activated by an electro-hydraulic actuator. Depending, for example, on the steering angle, lateral acceleration, yaw

angle and driving speed, the system calculates the right distribution of wheel torque for any driving situation. In this way the power is specifically channelled to the outer rear wheel when steering or accelerating into a corner. The effect: the vehicle is effectively pressed into the corner by the drive force and follows the angle of the front wheels. The variable left and right drive forces also help stabilise the steering and the usual steering corrections are hardly necessary.

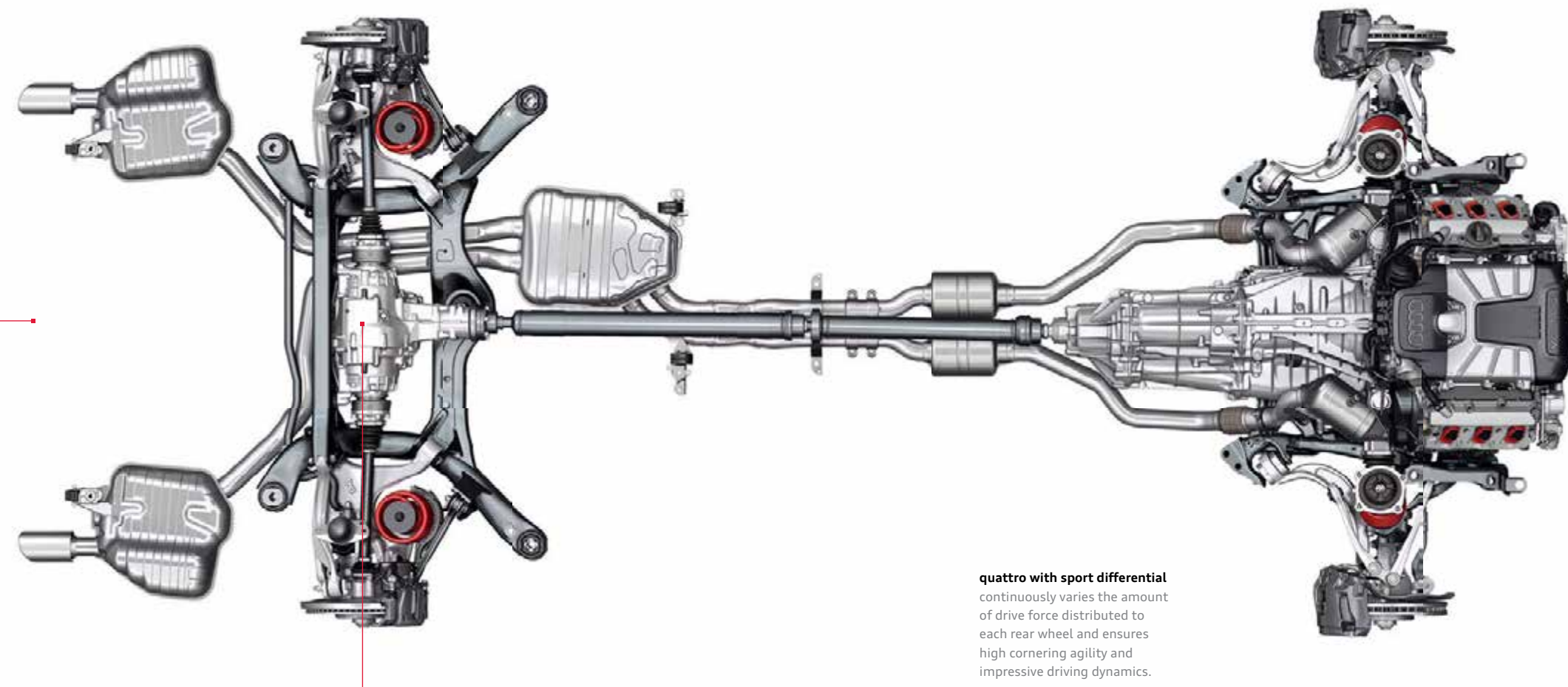

quattro with sport differential continuously varies the amount of drive force distributed to each rear wheel and ensures high cornering agility and impressive driving dynamics.

Why do the Audi A7 Sportback and the S7 Sportback suit you so well? Because they adapt themselves to you so well.

Audi drive select.



comfort



dynamic



auto



efficiency



individual

Everybody defines driving dynamics differently. We define it like this: drive exactly how you feel. With the standard Audi drive select, you can influence individual vehicle components at the push of a button and so change the character of your Audi.

You have up to five modes to choose from: efficiency, comfort, dynamic, auto and the additional mode 'individual' which allows you to determine yourself how the associated vehicle components should behave. The comfort mode is especially suitable for providing the most relaxed driving possible on long journeys. The auto mode

offers a generally comfortable yet sporty driving experience. For particularly sporty driving, for example on winding roads, there is the dynamic mode. The efficiency mode for the TFSI and TDI engines helps to optimise the car's overall consumption. As an integral part of Audi drive select, it is characterised by a modified gear change program and more energy-efficient operation.

In every mode, the vehicle adjustments depend on the equipment present. Audi drive select affects the engine, transmission and steering as standard. In addition, you can, when available,

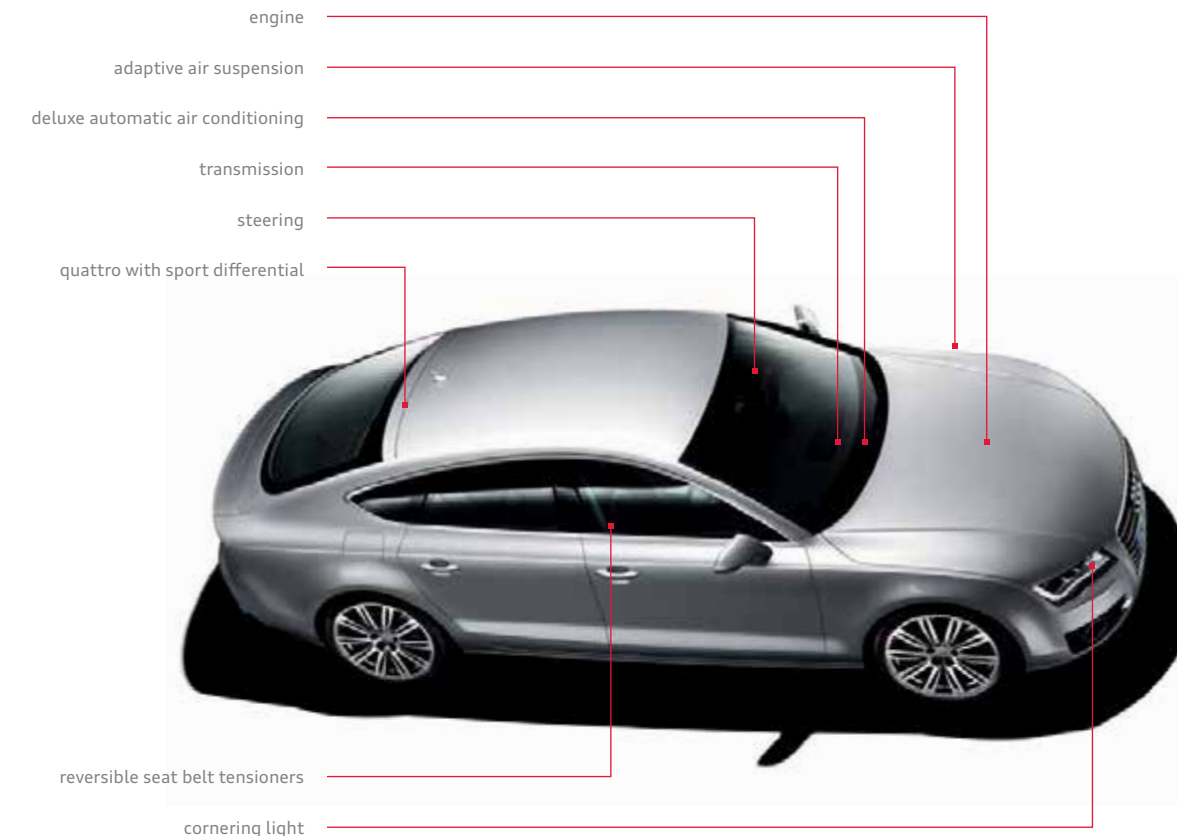

influence the adaptive air suspension with damper regulation, the quattro with sport differential, the reversible seat belt tensioners (part of Audi pre sense basic) and the cornering light. The engine and gears react more spontaneously or in a more balanced manner to movements of the accelerator, depending on the mode chosen. Moreover, the engine speeds at which gear changes take place are varied – in dynamic mode, they only happen at higher engine speeds, while in comfort mode they take place at lower ones. The steering can also be adapted to the driving situation, from sporty and firm to comfortable. The threshold at which the optional reversible

seat belt tensioners are triggered is adjusted in the dynamic mode. The vehicle height and the damping forces of the damper regulation can be varied using the adaptive air suspension. The optional sport differential distributes the drive force variably to the rear axle to attain a high level of agility and acceleration performance while cornering. In addition, the cornering light accompanies the selected mode with its adapted swivelling response.



Fully load-bearing air springs on the front and rear axles of the vehicle provide a sporty and comfortable driving feel.

The almost infinitely variable damping adjusts itself automatically to every driving situation in fractions of a second. Even with asymmetrically distributed loads, the vehicle remains in a level position thanks to continuous ride-height regulation.

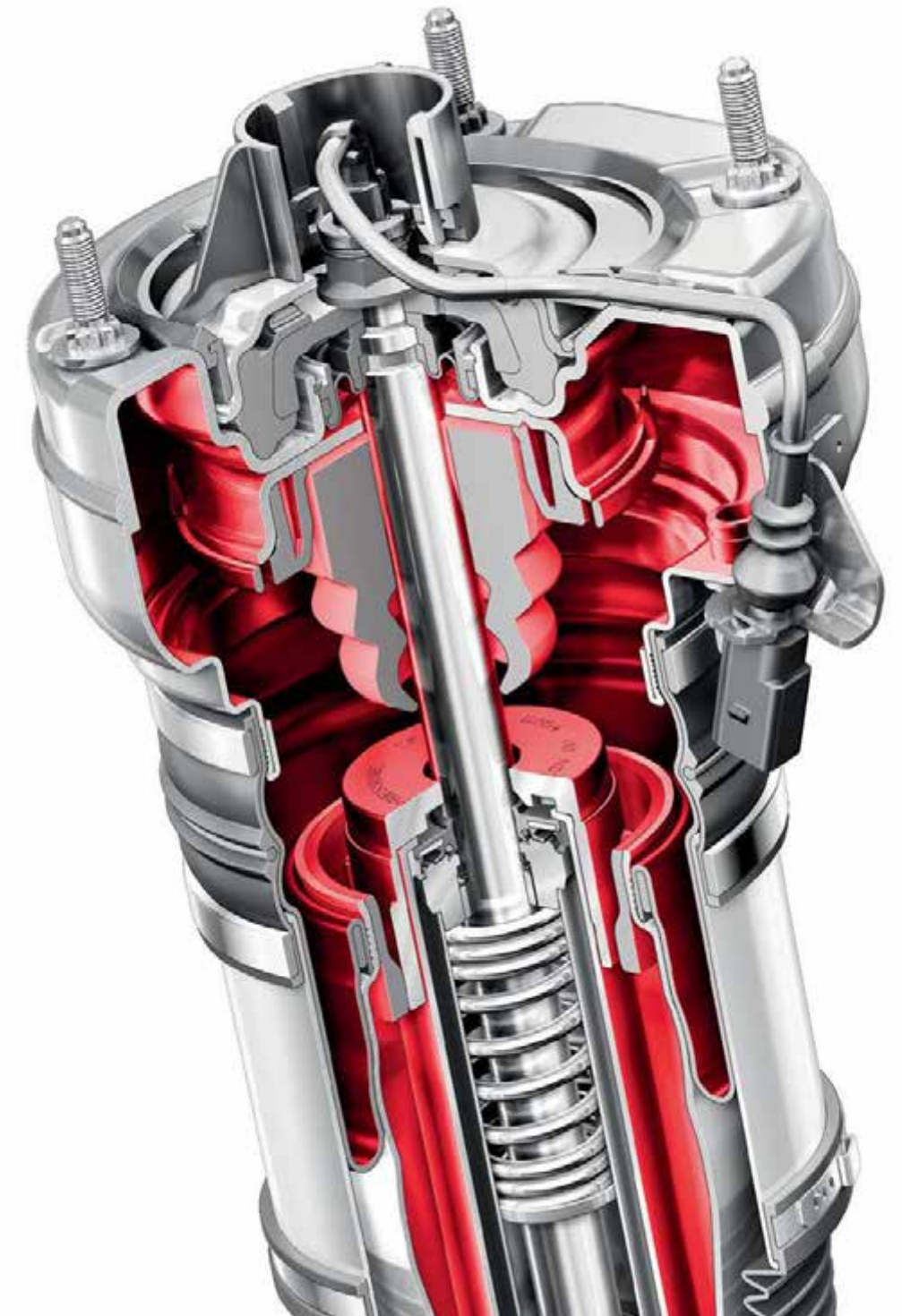

Dynamics and comfort were once opposites. We've made the differences vanish into thin air.

Every road is different – but there's no reason for you to notice. How do we do it?

In the Audi A7 Sportback, the optional adaptive air suspension adapts the suspension to many driving situations and to the road surface. An electronically controlled air suspension system operates individually on each of the four wheels and is combined with an infinitely variable adaptive damping system. Sensors on the body and on the axles monitor the current driving situation and send information to the system during the journey. Furthermore, the air springs guarantee that, even when carrying heavy loads, the vehicle's driving characteristics will hardly be

impaired. The Audi S7 Sportback features the new adaptive air suspension sport with S7-specific tuning as standard. The more tightly configured air suspension with variable damper coordination lowers the body's trim. The adaptive air suspension sport is controlled by Audi drive select and has been designed to be very agile – without compromising on comfort.

The standard high-performance brake system in the S7 Sportback takes a powerful hold with its all-round ventilated brake discs. These comprise a cast friction ring which is connected to the aluminium brake disc chamber by means of steel pins. This so-called floating mounting ensures

that the friction ring remains largely free of tension, improving stability under extreme temperature loads. The optional 19-inch ceramic brake* is available for the S7 Sportback, and with certain engines for the A7 Sportback, for even more demanding loads. In this brake system, the brake discs are made of a carbon-fibre reinforced ceramic material which is based on hard and abrasion-proof silicon carbide. This combination results in an enormous abrasion resistance which allows extremely high mileages to be achieved, while reducing sensitivity to high thermal loads.



The fuel consumption and CO₂ emission figures can be found from page 104 onwards.
*Please consult your Audi partner or national Audi website to find out more about the special features of the ceramic brake.



MMI touch: You can “write” with your finger on the optional MMI touch. The system recognises letters and numbers. It can be used for navigation and for your phone. In jukebox mode, you can also thumb through the albums of your music collection with a brief flick of the finger.



Navigation system: The optional hard disc navigation system MMI navigation plus with MMI touch provides a 3D map view and a three-dimensional representation of well-known buildings and sights.



Media: Display of available media sources such as the jukebox, inserted SDHC cards, Audi music interface or CDs and DVDs; display of optional TV tuners



Audi connect: All the services supported by Audi connect can be used quickly and easily with the MMI. The intuitive operation of the MMI makes internet access extremely easy.

Follow your intuition.

And you'll get there.

We try to match up to our claim of "Vorsprung durch Technik" in every aspect of an Audi – for example with the advanced optional MMI – Multi Media Interface. The MMI is used to control a wide variety of media in the vehicle, as well as the navigation system and other convenience functions. In addition, you can use it to control the optional services supported by Audi connect.

It used to be simple to operate the MMI – and now it's even simpler. A reduced number of buttons brings greater clarity. All six so-called hard keys, for telephone, navigation or car set-up functions for example, are located around the

central rotary/push-button control – for intuitive operation. The operating buttons for radio and media are logically arranged near the volume control. The carousel layout in the MMI display provides you with an even better overview, making it easier for you to get to where you want to be.

The 6.5-inch or 8-inch colour display, which pops up electrically, presents all the information in a very attractive look and with impressive clarity.

What makes the optional MMI navigation plus with 8-inch display special is the MMI touch – a touch-sensitive control panel for intuitive

operation of the MMI. It offers you, among other things, an intelligent way of controlling the navigation functions – by “writing” letters or numbers on the control panel with your finger. The system acknowledges your input after each character by means of audible feedback. You can also browse through the albums in your music collection on the jukebox – a brief flick of the finger on the touch pad is all it takes.



Audi connect:

The intelligent connection between the internet, the vehicle and you.

These days, we are connected everywhere and at all times – at home, at work and on the move. Being connected whenever you wish, even in your car, is what modern mobility is all about. Audi connect keeps you connected to the world via the data module integrated in the vehicle. You can access the contacts and music collection on your mobile phone¹ conveniently and directly via Bluetooth. In addition, there is a Wi-Fi hotspot for wireless connection of up to eight mobile devices. You can use Audi connect to find out more about cultural events in town, find the cheapest petrol stations nearby, put your own

personal route together at home and then transfer it to the navigation system, or explore your destination online in advance. The numerous integrated services and functions allow the vehicle to become part of the global network – increasing comfort and taking automotive fun to new heights. Simple, fast and customised.

Further detailed notes about availability and legal information about Audi connect, the technical requirements (necessary optional equipment, mobile phone contract, registration), any costs which may be incurred and the

respective conditions of use can be found on page 94 of this catalogue. Please contact your Audi partner for information about the availability and scope of the services supported by Audi connect or visit www.audi.com/connect.



If you want to experience the full diversity of Audi connect, scan this QR code using your smartphone. Or follow this link in your browser: www.audi.com/audiconnecta7

Mobility & navigation



Point-of-interest (POI) search with voice control
in the Google™ database²



Traffic information online
Detailed information on traffic flows, e.g. for individual stretches of road; faster and more precise information on the occurrence and clearing of traffic jams



Navigation with Google Earth™ map service² and Google Street View™²
with high-resolution (30 m zoom) aerial and satellite images, photos, business entries etc.



Fuel prices
The cheapest petrol stations at your destination or in the vicinity



Parking information
Help with looking for car parks and multi-storays incl. price details. And – if available – details about vacant spaces

Communication



Wi-Fi hotspot
connects your mobile devices to the internet

Infotainment



Weather
Charts and weather maps relating to the destination



Audi music stream
Access to global radio stations via smartphone app and Wi-Fi connection



News online
Text and images about current world events



City events
Up-to-date information about events e.g. in your vicinity or at your destination



Travel information
Professionally prepared sightseeing information, with read-aloud and import function directly to your navigation destination



myAudi – your personal “control centre”
Put your own personal route together at home and send it to your Audi MMI. Destinations can be entered via audi.com/myaudi, via the myAudi mobile assistant app or via Google Maps™.



¹ Please visit www.audi.com/bluetooth or contact your mobile service provider for the compatibility test and further information.

² Google and the Google logo are registered trademarks of Google Inc.

You sit at the wheel.

Others are working in the background.

Most road accidents are caused by human error. In many cases, the results of accidents can be reduced by modern assistance systems. Audi puts various different technologies to work to help you reach your destination safely. The assistance systems work closely together, which increases their versatility and performance – and makes your trip more comfortable at the same time.

To help you relax on the way to your destination, the optional MMI navigation plus with MMI touch allows you to connect some of the assistance systems with GPS navigation data even when route guidance is switched off. Linking the adaptive cruise control, camera-based speed limit display, and adaptive light with variable headlight range control assistance systems with GPS data from your environment means they can provide more anticipatory support.



adaptive cruise control with Stop&Go function (including Audi pre sense front)*: The automatic distance control uses radar sensors, a video camera and the sensors from the parking system to monitor the area around the vehicle. Within system limits, the vehicle brakes and accelerates automatically, keeping the distance set by the driver to the traffic ahead constant. In slow-moving traffic or in a traffic jam, system-controlled braking to a stop and automatic restart at driver's request are possible.



Audi active lane assist* helps to keep you in lane when travelling at speeds from about 60 to 250 km/h for instance by applying a gentle corrective steering movement. There are two respective system settings for you to choose from in the MMI (steering point early or late).

Audi side assist (including Audi pre sense rear)*: The lane change assistant helps you to change lanes. From a speed of about 30 km/h, it monitors the area alongside and behind the vehicle. Radar sensors at the rear detect any vehicles that may be in the blind spot or approaching quickly from behind. If Audi side assist deems that a detected vehicle will compromise a lane change, it signals this by means of an LED display on the corresponding exterior mirror.

Please note: The systems can only work within system limits. They can be of assistance, but drivers are still required to be attentive at all times.

*Optional equipment.





Because in
an emergency,
a second is
0.9 seconds too long.

Audi pre sense.

The Audi A7 Sportback and S7 Sportback do not only come with many new technical innovations but also, on request, with something extra special: a sort of sixth sense – or Audi pre sense. Various vehicle systems are used to categorise different driving situations and, where necessary, implement actions for preventive occupant protection or for collision reduction.

Radar sensors at the front and rear (depending on the equipment fitted) gauge the area in front of and behind your vehicle. A video camera also monitors the road in front of you. It is located in the area of the interior mirror – the highest possible point inside the vehicle – and delivers 25 pictures per second with a resolution that has yet to be matched in the field of automotive

engineering. In addition, the ESC control unit transmits further data. Using these different sources of information, Audi pre sense can create a very realistic picture of the vehicle's surroundings.

The optional Audi pre sense basic includes various preventive passenger protection systems that are activated in the event of a critical driving situation. These include: tensioning of the front seat belts, activation of the hazard warning system, and closing of the windows and, if present, the sliding roof.

Audi pre sense front additionally monitors the traffic ahead via the radar sensors of the optional adaptive cruise control with Stop&Go function.

In critical situations, the Audi braking guard contained with it warns the driver and increases the braking force if necessary. In extreme cases, the preventive protection systems are activated.

Audi pre sense rear monitors the traffic behind the vehicle with the help of the rear sensors of the optional Audi side assist.

Audi pre sense plus is included if ordering the optional adaptive cruise control with Stop&Go function and Audi side assist. In addition to the functions of Audi pre sense front, Audi pre sense plus activates the Audi braking guard in certain situations in which a collision is unavoidable and initiates maximum deceleration to minimise the impact speed of the crash by up to 40 km/h.

Turning night into day.

At the press of a button.



The human eye is one of the most sensitive sensory organs. But even it can sometimes miss something. For example, when it is dark or you have been dazzled. We are doing our best to help you in these situations. The optional night vision assistant with highlighting of detected pedestrians records the area in front of the vehicle using a thermal imaging camera and highlights any identified pedestrian located between approx. 15 and 90 metres away with yellow highlighting in the image. Should the system detect an imminent collision between the vehicle and an identified pedestrian, then the colour of the highlighting will change to red

and a warning tone will sound. In addition, the person is illuminated with 3 successive brief flashes of the right headlight (marking light). The night vision assistant can be turned on or off via a button on the rotary light switch. Pedestrian highlighting, warning signals and image contrast are configured in the car menu. The optional head-up display forms a useful complement to the night vision assistant. At any time of day it projects a clear, easy-to-read, full-colour virtual image beyond the windscreen. The image content is portrayed directly within the driver's field of vision to minimise any driver distraction. The head-up display therefore contributes to greater

traffic safety. You can configure image content via the car menu. As well as displaying current driving speed and navigation data, information from the driver assistance systems and speed limit display can also be shown. When the night vision assistant with highlighting of detected pedestrians is activated and a potential danger is detected, a warning symbol appears in the head-up display. You can easily configure the head-up display to your individual seat position.

Pedestrians identified in the detection area are highlighted in yellow.



Should the system detect an imminent collision, the highlighting turns from yellow to red and a warning tone will sound. In addition, the person is illuminated with 3 successive brief flashes of the right headlight (marking light).



< 300 °C

Conventional light bulbs reach temperatures of up to 300 °C. Due to their sophisticated technology, LED lights are somewhat more sensitive and should not get hotter than 150 °C. Because of the engine, the temperature of the area around the headlights is already around 120 °C. In theory, then, LED headlights would need an additional cooling system to be able to work. However, the Audi engineers did not want to spoil the good low-energy credentials of the LED headlights, so they quickly developed something completely new: a fan which directs heat away from the LED chips. The special feature of this fan is its additional benefit. The high operating temperature of standard bulbs means that they can defrost the headlights, which LEDs cannot. The newly developed fan directs warm air from the LED chips directly to the headlight lens and thus defrosts them and prevents them from misting up.



Daytime running lights

Dipped beam

Indicator

Less energy, more light:

Your Audi with full-LED headlights.

The Audi R8 was setting standards as early as 2008 as the first sports car with full-LED headlights. Now this special lighting is also available for the Audi A7 Sportback and S7 Sportback on request. Full-LED headlights not only require less energy than standard lighting systems, but also provide white light the colour of daylight, which is perceived to be much more pleasant. The dipped beam consists of a distinctive line of 3 individual light modules.

This makes the Audi A7 Sportback unmistakable, even at night. The high beam, daytime running lights and indicators also feature LED technology. The use of modern LEDs for all functions makes completely new lighting effects possible. The Audi A7 Sportback and S7 Sportback therefore have the right light for every situation: they have a motorway light which automatically almost doubles the range of the light cone on the driver's side (from approx. 70 m at dipped beam

to 120 m with motorway light). In addition, your vehicle has daytime running lights and indicators as well as an all-weather light which makes conventional front fog lights superfluous. The individual LED modules are skilfully controlled to redistribute the light, reducing glare from rain or fog.

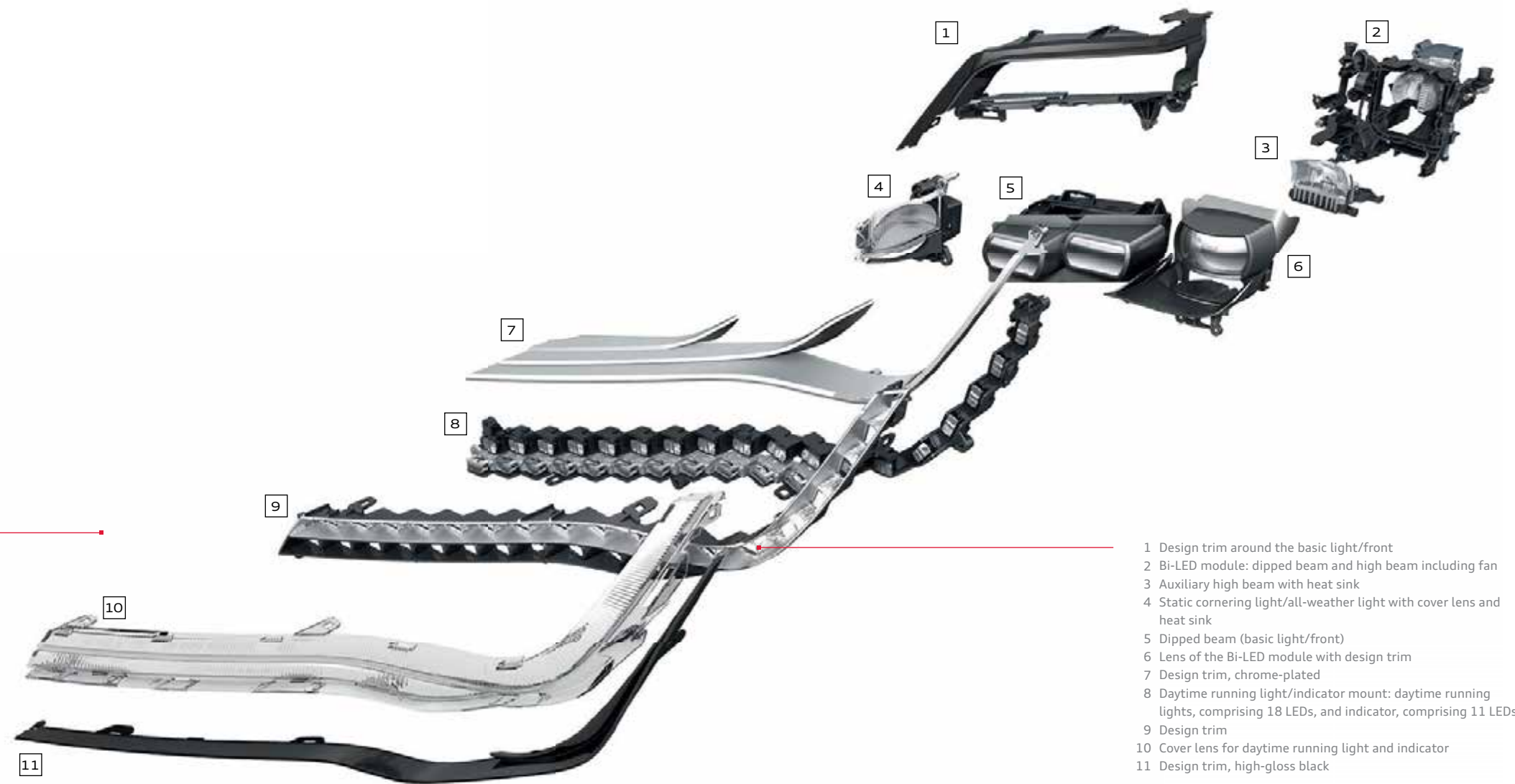

- 1 Design trim around the basic light/front
- 2 Bi-LED module: dipped beam and high beam including fan
- 3 Auxiliary high beam with heat sink
- 4 Static cornering light/all-weather light with cover lens and heat sink
- 5 Dipped beam (basic light/front)
- 6 Lens of the Bi-LED module with design trim
- 7 Design trim, chrome-plated
- 8 Daytime running light/indicator mount: daytime running lights, comprising 18 LEDs, and indicator, comprising 11 LEDs
- 9 Design trim
- 10 Cover lens for daytime running light and indicator
- 11 Design trim, high-gloss black

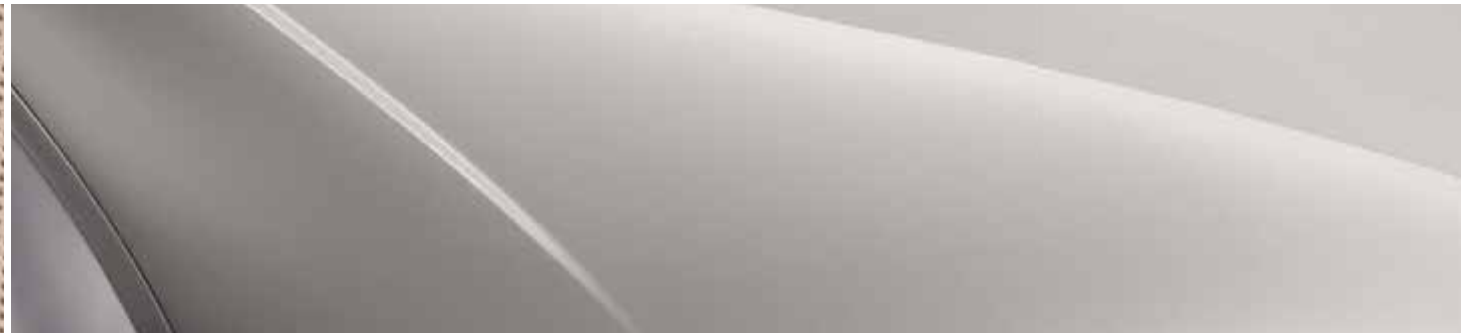

It is the equipment that turns an Audi into your Audi.

Audi exclusive

Exclusivity does not know the meaning of the word compromise. But it is familiar with endless variety.

Each year Audi sells over a million vehicles. Yet they only sell yours once. How is that possible? With Audi exclusive. This makes your Audi unmistakable.

Combine selected décors, coloured leather and a customised paint finish from the large selection of colours available from Audi exclusive to suit your personal wishes. Your unique vehicle will be the result.

Find out more about this topic from your Audi partner and in the Audi exclusive studio in Neckarsulm.

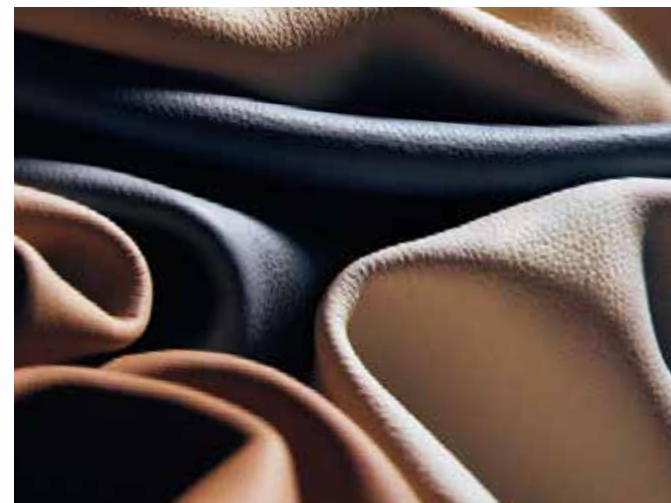

Comfort seats in alabaster white with chestnut brown stitching, inlays in oak sepia, Audi exclusive steering wheel rim in chestnut brown leather including leather-covered airbag cover with contrasting stitching in alabaster white and extended Audi exclusive leather package. From quattro GmbH

S line. Visibly more sportiness.

Driving an Audi A7 Sportback is a clear commitment to automotive sportiness. The S line packages allow you to enhance the athletic appearance of your Audi A7 Sportback even more: with a range of equipment that accentuates its dynamic lines, gives its interior a perceptibly sporty identity and further improves its driving performance. Choose how to up the sportiness.



S line exterior package

Bumpers, front and rear, side radiator grilles, side sill trims and diffuser insert in a striking, sporty design

Centre front spoiler edge and diffuser insert painted in platinum grey

Door sill trims with S line logo (in conjunction with ambient lighting without S line logo)

S line logos on the front wings



Front bumper and side radiator grilles in distinctive, sporty design



Diffuser insert painted platinum grey



Black interior with contrasting stitching, sport seats with seat upholstery in perforated Alcantara/leather and S line embossing, inlays in matt brushed aluminium



S line leather-covered multifunction sport steering wheel with contrasting stitching and S line emblem



Audi exclusive cast aluminium wheels in 5-twin-spoke design

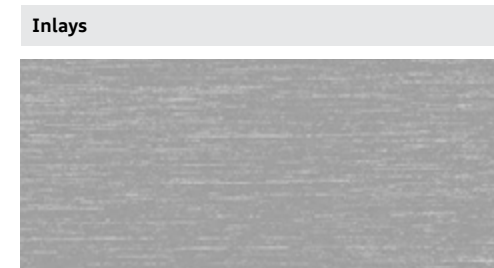

Matt brushed aluminium



Perforated Alcantara/leather, black

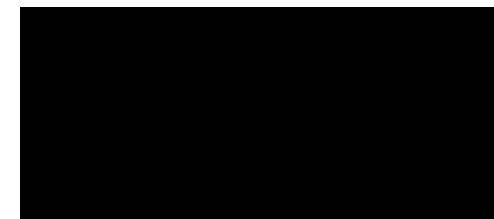

Piano finish, black
From quattro GmbH

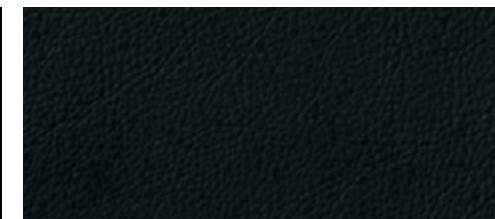

Valcona leather, black



Fine grain ash, natural brown



Daytona grey, pearl effect



Oak Beaufort

Additional exterior paint finish option

S line sport package

The following features are included in the S line sport package:

Audi exclusive cast aluminium wheels in 5-twin-spoke design
size 9 J x 19 with 255/40 R 19 tyres*

S line sport suspension

with more dynamic suspension tuning and vehicle lowered by 20 mm compared to dynamic suspension

S line logos

on the front wings and door sill trims (in conjunction with ambient lighting without S line logo)

Interior, dashboard and headlining

in black; contrasting stitching on seat upholstery, leather-covered sport steering wheel and gear lever gaiter (for perforated Alcantara/leather), lower part of the centre console in leather

Sport seats, front

with manual adjustment of seat height, fore/aft position, seat and backrest angle, seat belt height, head restraint height and clearance, as well as electric adjustment of the 4-way lumbar support; with shaped seat side bolsters for better lateral support when cornering and extendible thigh support

S line leather-covered multifunction sport steering wheel in 3-spoke design

Steering wheel grips in perforated black leather

Selector lever knob

in perforated black leather

S line inlays

in matt brushed aluminium

Optionally available:

Audi exclusive forged aluminium wheels in 7-twin-spoke design or Audi exclusive cast aluminium wheels in 5-segment-spoke design
size 9 J x 20 with 265/35 R 20 tyres*, as well as further wheels in 19 inch (or larger)

adaptive air suspension

S sport seats, front

including S sport seats in the rear

The following options are available for seat upholstery:

S line seat upholstery in perforated Alcantara/leather or Valcona leather
each in black and with S line embossing on the front seat backrests

S line leather-covered multifunction sport steering wheel in 3-spoke design with shift paddles
optionally heated; in black leather and with S line emblem; steering wheel grips in perforated leather

S line inlays

in piano finish, black, fine grain ash, natural brown, or oak Beaufort

Paint finish

in all standard and optional equipment colours and additionally in the special colour of Daytona grey, pearl effect

*You will find specifications on the technical characteristics of tyres on page 107.



Audi A7 Sportback in Havana black, metallic, with xenon plus headlights and forged aluminium wheels in 10-parallel-spoke design.
Equipment: standard seats, front in Valcona leather, nougat brown, inlays in matt brushed aluminium and a leather-covered multifunction sport steering wheel in 3-spoke design



Audi A7 Sportback in Dakota grey, metallic, with cast aluminium wheels in 5-arm Y design.
Equipment: comfort seats, front, with memory function and seat ventilation in Valcona leather, velvet beige, inlays in fine grain ash, natural brown



Solid paint finishes



Ibis white

Metallic paint finishes



Glacier white, metallic

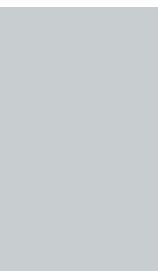

Dakota grey, metallic

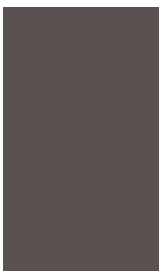

Havana black, metallic

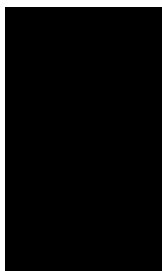

Pearl effect paint finishes



Impala beige, pearl effect

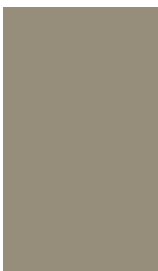

Deep green, pearl effect



Crystal effect paint finish



Estoril blue, crystal effect



Customised paint finishes



Audi exclusive customised paint finishes
From quattro GmbH



Brilliant black



Ice silver, metallic

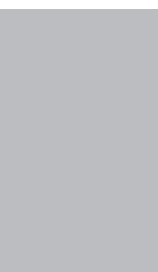

Oolong grey, metallic



Garnet red, pearl effect



Phantom black, pearl effect



Quartz grey, metallic



Moonlight blue, metallic



Wheels/tyres



Forged aluminium wheels in 6-arm design
size 8 J x 17 with 235/55 R 17 tyres*



Cast aluminium wheels in 5-arm Y design
size 8.5 J x 19 with 255/40 R 19 tyres*



Forged aluminium wheels in 10-parallel-spoke design
anthracite, partly polished,
size 9 J x 20 with 265/35 R 20 tyres*



Audi exclusive forged aluminium wheels in 7-twin-spoke design
polished, 2-tone,
size 9 J x 20 with 265/35 R 20 tyres*.
From quattro GmbH



Cast aluminium wheels in 7-arm dynamic design
size 8.5 J x 18 with 255/45 R 18 tyres*



Cast aluminium wheels in 10-spoke design
size 8.5 J x 19 with 255/40 R 19 tyres*, optionally
available with run-flat tyres



Cast aluminium wheels in 5-parallel-spoke star design (S design)
size 9 J x 20 with 265/35 R 20 tyres*



Audi exclusive forged aluminium wheels in 7-twin-spoke design
high-gloss polished finish, single colour,
size 9 J x 20 with 265/35 R 20 tyres*.
From quattro GmbH



Cast aluminium wheels in 5-parallel-spoke design (S design)
size 8.5 J x 19 with 255/40 R 19 tyres*



Audi exclusive cast aluminium wheels in 5-twin-spoke design
size 9 J x 19 with 255/40 R 19 tyres*
From quattro GmbH



Audi exclusive cast aluminium wheels in 5-segment-spoke design
size 9 J x 20 with 265/35 R 20 tyres*.
From quattro GmbH

Wheels/tyres



Audi exclusive cast aluminium wheels in 5-arm rotor design
size 9 J x 21 with 275/30 R 21 tyres*.
From quattro GmbH



Forged aluminium winter wheels in 6-arm design
size 7 J x 17 with 235/55 R 17 tyres*, can be fitted with
snow chains, permissible top speed 210 km/h



Audi exclusive cast aluminium wheels in 5-arm rotor design
Matt titanium look, high-gloss turned finish,
size 9 J x 21 with 275/30 R 21 tyres*.
From quattro GmbH



Cast aluminium winter wheels in 10-spoke design
size 8 J x 19 with 235/45 R 19 tyres, can be fitted with
snow chains, permissible top speed 240 km/h



Cast aluminium winter wheels in 5-parallel-spoke star design (S design)
size 9 J x 20 with 265/35 R 20 tyres*, cannot be fitted
with snow chains, permissible top speed 240 km/h

Run-flat tyres

Journey can be continued on a flat tyre at a speed of up to 80 km/h and for a maximum distance of 30 km, without having to change the wheel.

Anti-theft wheel bolts

can only be loosened using adaptor provided

Tyre repair kit

with 12V compressor and tyre sealant, located under the loading floor cover in the luggage compartment, top speed 80 km/h

Spare wheel, space-saving

Tyre pressure loss indicator

visual and acoustic warning if the pressure drops in one or more tyres; displayed in the driver information system

Vehicle tool kit

in the luggage compartment

Vehicle jack

in the luggage compartment



Standard seats, front
 with manual adjustment of seat height, fore/aft position, backrest angle, head restraint height and clearance, as well as the belt height; for S7 Sportback with electric adjustment of seat height, fore/aft position, seat and backrest angle, thigh support, as well as electric 4-way lumbar support for the front seats; including memory function for driver seat and exterior mirrors; optional front seat ventilation. (The image on the left shows standard seat, front, in Milano leather, velvet beige with manual seat adjustment; the image on the right shows standard seat in perforated Milano leather, velvet beige with seat ventilation, front and with electric seat adjustment.)

The model-specific standard and optional equipment can be found in the index from page 110 onwards.

Cloth upholstery and trim



Horizon cloth, black

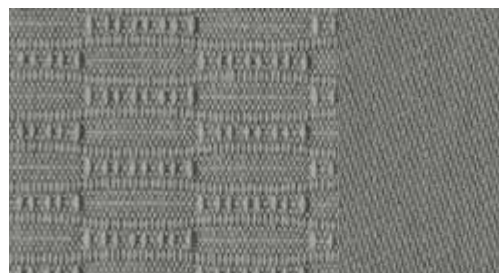

Horizon cloth, titanium grey



Horizon cloth, velvet beige

Leather upholstery and trim

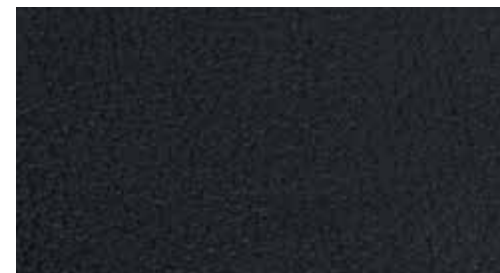

Milano leather, black*



Milano leather, nougat brown*

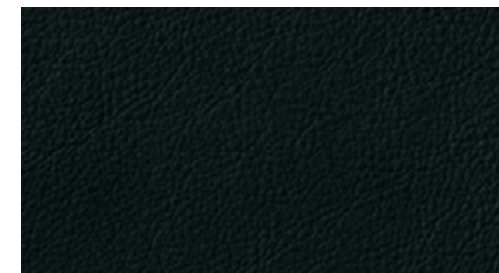

Valcona leather, black



Valcona leather, nougat brown



Milano leather, titanium grey*

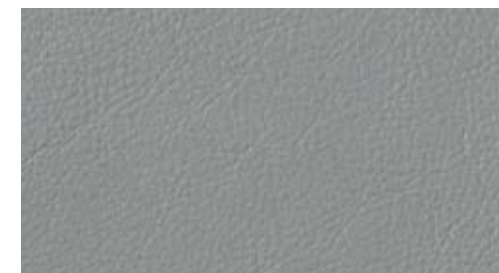

Valcona leather, titanium grey



Valcona leather, Goa beige



Milano leather, velvet beige*



Valcona leather, velvet beige



Audi exclusive leather upholstery and trim
 From quattro GmbH

*Optional front seat ventilation. (The leather on the front and outer rear seats is perforated.)



Comfort seats, front, with memory function
 with electric adjustment of seat height, fore/aft position, seat and backrest angle, as well as thigh support; pneumatic adjustment of seat and backrest side bolsters, as well as pneumatic lumbar support; manual adjustment of head restraint height and clearance, as well as belt height; including memory function for driver and front-passenger seat and exterior mirrors; optional front seat ventilation. (The image shows comfort seat, front, in perforated Valcona leather, titanium grey with seat ventilation, front)

Leather upholstery and trim

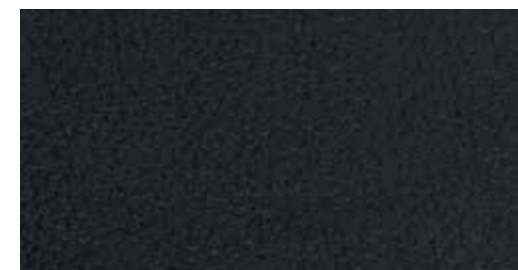

Milano leather, black



Milano leather, nougat brown



Milano leather, titanium grey



Milano leather, velvet beige

Leather upholstery and trim

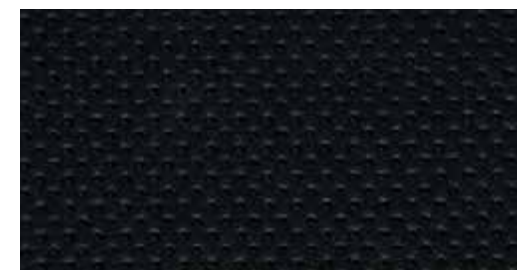

Valcona leather, black*



Valcona leather, Goa beige*



Audi exclusive leather upholstery and trim
 From quattro GmbH

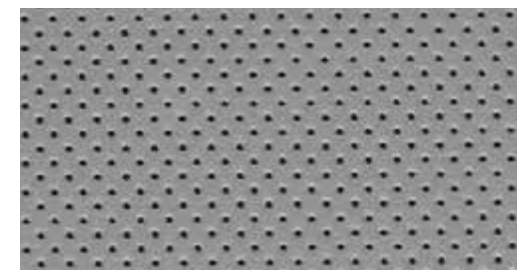

Valcona leather, titanium grey*



Valcona leather, velvet beige*

*Only available in conjunction with seat ventilation, front. (The leather on the front and outer rear seats is perforated.)



S sport seats, front

with electric adjustment of the seat height, fore/aft position, seat and backrest angle; manual adjustment of belt height; with shaped seat side bolsters for better lateral support in curves, extendible thigh support, electric 4-way lumbar support as well as integrated head restraints, including memory function for driver seat and exterior mirrors; with S7 embossing on the front seat backrests; rear seats with shaped seat contours, visually matched to the front seats. (The image shows S sport seat, front, in Valcona leather, black, with contrasting stitching.)

Leather upholstery and trim



Alcantara/leather, black



Valcona leather, black with contrasting stitching



Alcantara/leather, lunar silver



Valcona leather, lunar silver with contrasting stitching



Audi exclusive leather upholstery and trim

From quattro GmbH

Cloth and leather upholstery and trim

Horizon upholstery and trim

seat centre panel in Horizon cloth, seat side bolsters, head restraints, centre armrests, front and door trim inserts in single-colour cloth

Milano leather upholstery and trim

seat centre panel, seat side bolsters, head restraint centre panel and centre armrest, front, in Milano leather; for S7 Sportback lower part of centre console also in leather; Milano leather is fully penetrated with dye and lacquered, which offers excellent surface protection. The leather is extremely hard-wearing and durable, tanned without the use of chromium and gives a high-quality impression with its fine, grained surface.

Valcona leather upholstery and trim

for standard seats, front:

seat centre panel, seat side bolsters, head restraints, door trim inserts and centre armrest, front, in Valcona leather; lower part of the centre console in leather; for comfort seats, front with seat ventilation:

seat centre panel on the front seats and non-ventilated seat centre panel of both outer rear seats in perforated Valcona leather; seat side bolsters, middle rear seat (optional), head restraints, door trim inserts and centre armrest, front, in Valcona leather; lower part of centre console in leather;

for S sport seats, front:

seat centre panel, seat side bolsters, head restraints, centre armrest, front, and door trim inserts in Valcona leather; lower part of the centre console in leather; with S7 embossing on the front seat backrests; Valcona leather is high quality leather, which contributes to the elegant charisma of the interior. The low use of lacquer allows the material to breathe whilst the non-grained surface underlines the sophisticated character. Valcona leather is tanned without the use of chromium, dyed through and treated with non-fading colour pigments.

Alcantara/leather combination

seat centre panel and door trim inserts in Alcantara; seat side bolsters, head restraints, centre armrest, front, and lower part of centre console in leather; with S7 embossing on the front seat backrests; The Alcantara/leather combination gives the S sport seat an exclusive and sporty look. The seat centre panel in Alcantara provides exceptionally good support and is well suited for dynamic driving styles. The side bolsters made from the finest leather complete the look. Thanks to rapid temperature equalisation, this combination offers high levels of seating comfort and a good seating climate. It is particularly hard-wearing, easy to clean and resistant to wear and tear.

Leather-covered armrests in the door trims

Leather package

door armrests, lower part of centre console and door pull handles in fine Nappa leather

Leather package including airbag cover

door armrests and door pull handle in leather; in addition, steering wheel airbag cover in black leather; lower part of centre console leather-covered, if not already included in the selected equipment. From quattro GmbH

Audi exclusive leather package including airbag cover

leather trim the same as leather package including airbag cover; individual choice of colour for leather and decorative seams from the range of Audi exclusive colours; lower part of centre console also leather-covered, if not already included in the selected equipment. From quattro GmbH

Extended Audi exclusive leather package

dashboard underside including glove compartment and storage on the driver's side, armrests in the door trims, centre console, as well as lower part of centre console in leather. Individual choice of colour for the leather and the decorative stitching from the range of Audi exclusive colours; steering wheel airbag cover leather-covered in black. From quattro GmbH

Audi exclusive leather upholstery and trim (package 1)

available in Valcona leather and Alcantara/Valcona leather. Leather trim for: seats, centre arm rest, lower part of centre console and door trim insert. Optional Alcantara for seat centre panel and door trim inserts. Individual choice of colour for the leather, Alcantara and decorative stitching from the range of Audi exclusive colours. From quattro GmbH

Audi exclusive leather upholstery and trim (package 2)

available in Valcona leather. Contents in addition to package 1 are: armrest in the doors and seat backrest cover leather-covered. Seat attachments in matching colours. Individual choice of colour for the leather and decorative stitching from the range of Audi exclusive colours. From quattro GmbH

Audi exclusive piping for comfort seats

(can only be ordered in conjunction with Audi exclusive leather upholstery and trim package 1 or 2). From quattro GmbH

Headlinings

Headlining in cloth

matched to the selected interior colour

Headlining in cloth, black

Headlining in Alcantara black

headlining, upper pillar trim, rear parcel shelf and sun visors in Alcantara black, decorative stitching in black. From quattro GmbH

Headlining in Alcantara black with coloured Audi exclusive decorative stitching

headlining, upper pillar trim, rear parcel shelf and sun visors in Alcantara black. Individual choice of colour for decorative stitching from the range of Audi exclusive colours. From quattro GmbH



Inlay in oak Beaufort

Inlays

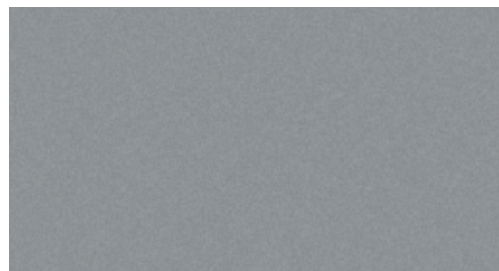

Micrometallic, platinum

Inlays



Carbon Atlas

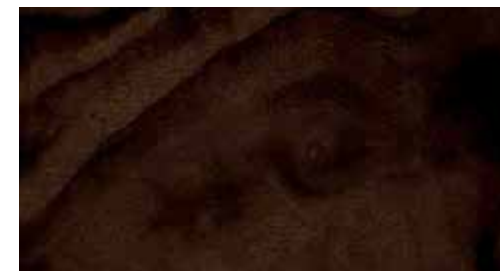

Walnut, dark brown

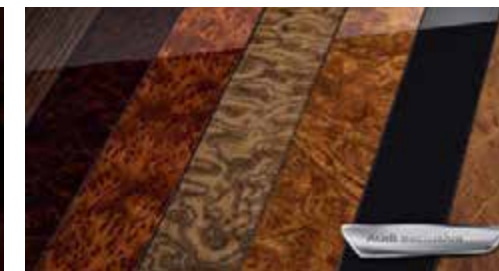
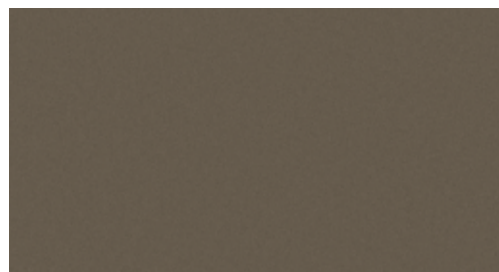
Audi exclusive inlays
From quattro GmbH

Reflex finish, moor brown

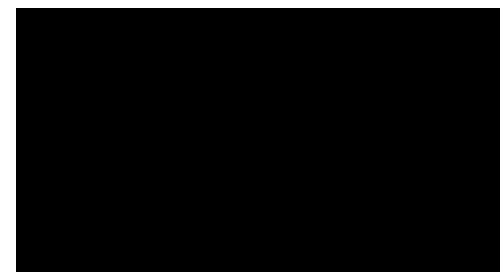
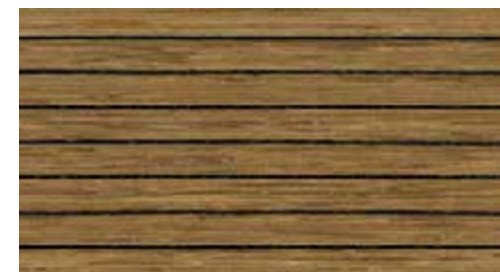
Piano finish, black
From quattro GmbH

Oak Beaufort

Inlays in micrometallic, platinum

full-surface for the dashboard, centre console, door trims and all-round inlay; for interior equipment in black, titanium grey, nougat brown and Goa beige

Inlays in reflex finish, moor brown

full-surface for the dashboard, centre console, door trims and all-round inlay; for interior equipment in velvet beige

Inlays in matt brushed aluminium

full-surface for the dashboard, centre console, door trims and all-round inlay

Inlays in carbon Atlas

full-surface for the dashboard, centre console, door trims and all-round inlay; surrounds for the all-round inlay; door trims and centre console in aluminium look

Inlays in piano finish, black

full-surface for the dashboard, centre console, door trims and all-round inlay; surrounds for the all-round inlay; door trims and centre console in aluminium look.
From quattro GmbH

Inlays in wood

full-surface for the dashboard, centre console, door trims and all-round inlay; surrounds for the all-round inlay; door trims and centre console in aluminium look

Inlays in oak Beaufort

full-surface for the dashboard, centre console, door trims and all-round inlay; surrounds for the all-round inlay; door trims and centre console in aluminium look; oak Beaufort is produced in an innovative procedure and consists of layered oak wood, in 2-colour design. The appearance of this inlay resembles the look characteristics for yachts.

Inlays in aluminium/Beaufort, black

full-surface for the dashboard, centre console, door trims and all-round inlay; surrounds for the all-round inlay; door trims and centre console in aluminium look; aluminium/Beaufort is produced in an innovative procedure and consists of aluminium layered with blackened wood. This unusual combination of materials combines natural elements with dynamism.
From quattro GmbH

Audi exclusive inlays

available in fine grain ash, nougat, oak sepia, fine grain myrtle, nutmeg, vavona bronze, Modrone gold, tamo ash, natural dark brown.
From quattro GmbH

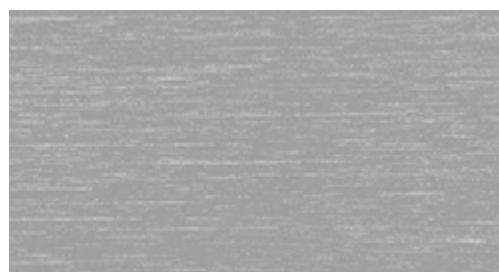

Matt brushed aluminium



Fine grain ash, natural brown

Aluminium/Beaufort, black
From quattro GmbH

Lights



Xenon plus

The headlights utilising durable gas discharge technology for dipped and high beam ensure intensive illumination of the road and provide good uniformity and range both close up and in the distance; including all-weather light. The automatic dynamic headlight beam control reduces dazzle for oncoming traffic; including homogeneous rear and daytime running light strip, indicators and brake lights as a light strip, each in LED technology with low power consumption. Including headlight cleaning system

adaptive light including variable headlight range control

consisting of dynamic cornering light, static turning light and variable headlight range control; the dynamic cornering light infers the course of the road from the movement of the steering wheel and variably illuminates the bend by pivoting the xenon headlights; operational between speeds of approximately 10 km/h and 110 km/h. The static turning light automatically switches on if the indicators have been engaged for a while at a low vehicle speed and illuminates the new direction in which the vehicle is travelling. The variable headlight range control features a camera on the interior mirror which registers sources of light from other road users. The range and width of the headlight beam are continuously varied between dipped and high beam to suit ambient conditions, ensuring that the headlights provide good visibility without dazzling other road users. The headlights also have 3 different light distribution modes which are activated according to the vehicle speed: town light, motorway light and country light. Including headlight cleaning system. In addition, Audi connect enables controlling of these 3 light distribution modes and the intersection light by the vehicle support based on navigation data, and with the aid of stored route data from the optional MMI navigation plus with MMI touch. The convenient functions of the lighting assistant are supplemented by the travel mode, with GPS-assisted switching between right and left-hand drive modes.



LED headlights

featuring LED dipped beam, high beam, daytime running lights, indicators, static turning light, all-weather light and motorway light function with LED technology; includes headlight cleaning system, high-beam assist for automatic switching between high and dipped beams, an all-weather light function to reduce the risk of the driver being dazzled when visibility is poor (in fog, rain or snow) and an additional motorway light which automatically increases headlight range from a speed of approximately 110 km/h; the LED technology allows near daylight illumination of the road for increased safety and comfort; minimal energy requirements, long service life, and excellent recognition by other road users

High-beam assist

Part of LED headlights; working within system limits, automatically detects the headlights of oncoming traffic, the rear lights of other road users and built-up areas. Depending on the traffic situation, the high beam is automatically switched on or off.

Lights



LED rear lights

brake lights, tail lights, rear fog lights and indicators, as well as rear number plate lights in LED technology; faster activation means earlier recognition by the driver behind; reversing lights in white, third high-mounted brake light in the rear window

adaptive brake light

brake light flashes during emergency braking to warn following traffic; hazard warning lights are activated automatically when the vehicle comes to a stop

Light/rain sensor

to control the automatic lights-on function, the windscreen wipers and the coming home/leaving home function: delayed switching-off/automatic switching-on of the main headlights, the rear lights and number plate lights, as well as the LED daytime running lights when parking/opening the vehicle

Interior lighting

front and rear, includes reading lights; with delayed switch-off and contact switches on all doors; entrance lighting, front, footwell lighting as well as illuminated door openers; reflected lighting for the centre console as well as vanity mirror, glove compartment and luggage compartment lighting; courtesy lighting in the tailgate

Interior and exterior lighting package

Interior lighting: ambient reflected light for door inner panels to help occupants better orient themselves, and entrance lighting, front and rear, in LED technology; vent controls illuminated

Exterior lighting: courtesy lighting on the underside of the door handles and door handle lighting in LED technology to facilitate entry and exit in the dark; automatically activated when the doors are unlocked; active internal door reflectors (bulbs)

Ambient lighting

with integrated eyewear compartment in roof module; additional to the interior and exterior lighting package, anti-glare illumination for the passenger compartment in LED technology:

- interior lighting, front and rear includes reading lights
- vanity mirror illumination
- ambient reflected light for centre console
- surround lighting for centre console
- lighting for door pockets
- illuminated door sill trims (with the optional S line packages the door sill trims are without the S line logo)

Configured via MMI

Mirrors

Exterior mirrors with integrated LED indicator electrically adjustable and heated, convex, flat or aspherical mirror glass; additionally with memory function if electrically adjustable front seats are ordered; exterior mirror housing painted in body colour, for S7 Sportback in aluminium look

also optionally:

folding

including automatic kerb-side function for the exterior mirror on the passenger side

automatically dimming on both sides

including automatic kerb-side function for the exterior mirror on the passenger side

heated and folding and automatically dimming on both sides

including automatic kerb-side function for the exterior mirror on the passenger side

The automatic kerb-side function tilts the exterior passenger mirror downwards when reverse gear is engaged, giving the driver a better view of the kerb.

Interior mirror

dimming

optionally:

automatically dimming

recognises with the aid of a photocell when the headlights behind are too bright and dims automatically

Roof system

Slide-and-tilt glass sunroof

electric, with tinted single-glazed safety glass and infinitely adjustable sun shield, integrated wind deflector, convenience closing from outside via the central locking or the radio controlled key

Closing systems



Convenience key including sensor-controlled release of the luggage compartment lid

Access authorisation system: the key only needs to be carried with you; the vehicle is locked and unlocked from outside via sensors on all 4 door handles; all door handles feature aluminium-look trim strips (in body colour in conjunction with Audi exclusive black high-gloss package). On detection of a specific foot gesture (kicking motion), a sensor in the rear bumper initiates a convenience key search in the rear area of the vehicle. When the key is detected, this opens the luggage compartment lid. For extra comfortable loading of the luggage compartment.

Power-assisted door closing

automatically pulls doors that are not completely engaged into the locks

Luggage compartment lid, electrically opening and closing

opening via the button on the vehicle key, button on the driver's door panel or soft touch button in the luggage compartment handle recess, or by foot gesture (kicking motion) in conjunction with the optional convenience key including sensor-controlled release of the luggage compartment; closing via button on inside of the luggage compartment lid, the button in the driver's door or via the optional convenience key (long press); including power-assisted closing and programmable luggage compartment opening angle

Garage door opener (HomeLink)

programmable radio-operated remote control, operating buttons incorporated into the front roof module; can be used to open many garage doors and exterior gates; allows control of security and lighting systems; step-by-step programming assistance provided by the MMI, code identification guidance and set-up assistance from appropriate logbook information on the screen, well integrated with the MMI to make it user friendly. (For information on compatible hand-held transmitters, please contact your Audi partner or visit www.eurohomelink.com).

Radio controlled key

unlocks and locks doors, luggage compartment lid and tank flap; includes convenient closing/opening of windows and the optional slide-and-tile glass sunroof; for S7 Sportback with S7 emblem

Engine start-stop button

with a red ring with the S7 Sportback; the engine is started and switched off via the engine start-stop button in the centre console; the key only needs to be carried with you.

Anti-theft alarm

with tow-away protection via angle of inclination sensors (can be switched off); including interior monitoring system which can be switched off; signal horn for monitoring doors, bonnet and luggage compartment lid independent of vehicle electrical system; automatically activated by the vehicle key

Preparation for tracking system

preparation for connecting a tracking system (available from Audi Genuine Accessories) that enables a stolen vehicle to be located

Glazing



Dark-tinted windows (privacy glazing)

dark-tinted rear window, rear door windows and rear side windows

Insulating/acoustic glass

2 panes of glass bonded together by a plastic film; improves exterior noise insulation and theft protection; with additional reflective coating to reduce the build-up of heat in the interior; rear window in standard glass; with viewing window for toll collection devices

Insulating/acoustic

glass and dark-tinted windows (privacy glazing) windscreen and front side windows in insulating/acoustic glass; dark-tinted rear window, rear door windows and rear side windows; with viewing window for toll collection devices

Glazing

Heat-insulating glass

green-tinted; windscreen made of laminated glass; rear window heated, with timer

Sun visors

for driver and front passenger; can be folded and swivelled; with illuminated vanity mirror that can be covered

Sun screen

in the luggage compartment cover, can be erected, in black cloth

Further exterior equipment

Provision for trailer towing hitch

includes fitting for the control units and reinforced engine cooling. The trailer towing hitch for retrofitting is available from Audi Genuine Accessories.

Trailer towing hitch

ball joint coupling and ball head made from forged steel, mechanically swivelling; operated via draw-button in the luggage compartment with control light and display in instrument cluster to monitor secure attachment of trailer towing hitch, includes trailer stabilisation system via the Electronic Stabilisation Control (ESC)

High-gloss package

window slot trims in anodised aluminium, external B-pillar trim in high-gloss black

Audi exclusive black high-gloss package

frame of the radiator grille in high-gloss black, number plate holder and radiator protective grille in black matt, applications on cooler protective grille and side air intakes in high-gloss black, roof frame and window slot trim in high-gloss black. From quattro GmbH

Audi Singleframe

high-gloss black paint finish, with horizontal chrome struts; for S7 Sportback platinum grey with horizontal double chrome struts

Exhaust tailpipes

dual-branch design with 1 tailpipe each left and right; for S7 Sportback 2 oval tailpipes each left and right; chrome-plated surrounds



Rear spoiler

integrated in the luggage compartment lid; automatically extends at 130 km/h, retracts at 80 km/h; can also be controlled manually using a button in the centre console

Model name/logo

for A7 Sportback model name on rear; "quattro" logo in radiator grille, on rear and on passenger's side of the dashboard; for S7 Sportback model name on rear and in radiator grille, on the leather-covered sport steering wheel and in the rev counter; "quattro" logo on passenger's side of the dashboard, "V8 T" emblem on the front wings; if required, vehicle can also be supplied without model name and/or logo on the rear

Seats/seating comfort



Front seats, electrically adjustable, including memory function for the driver seat

with electric adjustment of seat height, fore/aft position as well as seat and backrest angle; electric 4-way lumbar support; 2 presets for the electrically adjustable driver seat and exterior mirrors

4-way lumbar support for the front seats

electric, with horizontal and vertical adjustment

Seats/seating comfort

**Massage function, front**

massages the muscles using 10 pneumatic cushions; 5 different programs (Wave, Tapping, Stretch, Lumbar, Shoulder), each offering 5 levels of intensity; can be selected via multifunction switches on the seat or via MMI

Centre armrest, front

for driver and front passenger, with adjustable angle, fold-open design

**Rear seat system 2+1**

shaped outer rear seats, visually matched to the front seats, and an additional seating possibility in the centre; 3 head restraints, rear, in L-shape, height manually adjustable, for better rearward visibility; rear seat backrest can be split-folded 40:60 or fully; including fold-out centre armrest with storage compartment

S sport seats in the rear

2 single seats in the rear with shaped side bolsters and integrated head restraints, visually matched to the front seats; including storage tray between the outer rear seats which is divided into 2 separate storage surfaces; rear seat backrest can be split-folded 40:60 or fully; including fold-out centre armrest with storage compartment

**Rear seat system**

2 seats; visually matched to the front seats; 2 L-shaped rear head restraints, rear, height manually adjustable, for better rearward visibility; rear seat backrest can be split-folded 40:60 or fully; including fold-out centre armrest with storage compartment

ISOFIX child seat mounting for the outer rear seats

Standard bracket for the practical fastening of child seats in accordance with ISO standards; compatible child seats can be obtained from your Audi partner.

ISOFIX child seat mounting for the front-passenger seat

with passenger airbag deactivation switch, includes separate electric child-proof lock on rear doors

**Seat heating, front and rear**

functions as for seat heating, front; also for the outer rear seats, can be regulated separately

Seat heating, front

heats the seat and backrest centre panel, with leather upholstery and trim and sport seats also heats the seat side bolsters; can be individually adjusted in 3 stages for the driver and front-passenger seats via a direct selection button on the air conditioning controls

Seat ventilation, front

active ventilation of the seat and backrest centre panels, as well as the thigh support for the driver and front-passenger seats; using a fan for standard seats or by drawing in air on comfort seats, the system ensures a pleasant seating climate even at high ambient temperatures; adjustable in 3 stages directly on the air conditioning control. With seat ventilation, front, the leather on the front and outer rear seats is perforated.

Steering wheels/selector lever knobs/controls

**Leather-covered multifunction steering wheel in 4-spoke design with shift paddles**

same functions as leather-covered multifunction steering wheel in 4-spoke design, including shift paddles for manual gear change

Leather-covered multifunction steering wheel in 4-spoke design

with full-size airbag, with height and reach adjustment, including selector lever knob in leather; for operating the provided infotainment features

Leather-covered multifunction steering wheel in 4-spoke design, heated

same functions as leather-covered multifunction steering wheel in 4-spoke design; steering wheel rim additionally heated

**Leather-covered multifunction sport steering wheel in 3-spoke design with shift paddles**

same functions as leather-covered multifunction sport steering wheel in 3-spoke design, including shift paddles for manual gear change; for S7 Sportback additionally with S7 emblem and S-specific contrasting stitching

Leather-covered multifunction sport steering wheel in 3-spoke design with shift paddles, heated

same functions as leather-covered multifunction sport steering wheel in 3-spoke design with shift paddles; steering wheel rim additionally heated; for S7 Sportback additionally with S7 emblem and S-specific contrasting stitching

Leather-covered multifunction sport steering wheel in 3-spoke design

with full-size airbag, with height and reach adjustment, including selector lever knob in leather; for operating the provided infotainment features

**Audi exclusive steering wheel rim with wooden segments**

steering wheel rim customised with Audi exclusive wood (not in tamo ash, natural dark brown), available in 4-spoke design with shift paddles; leather and stitching available in various Audi exclusive colours; stitching on steering wheel rim with Audi exclusive-specific seam detail. From quattro GmbH

Audi exclusive leather steering wheel rim

available in all Audi exclusive colours; individual choice of colour for stitching in various Audi exclusive colours and with specific Audi exclusive seam detail. From quattro GmbH

Steering wheel rim with wooden segments

available as leather-covered multifunction steering wheel in 4-spoke design with shift paddles; in walnut, dark brown. From quattro GmbH

Electric steering wheel adjustment

adjustable in height and reach, with automatic entry and exit function

**Audi exclusive selector lever knob with wooden segment**

Customised selector lever knob with Audi exclusive wood (not in tamo ash, natural dark brown). From quattro GmbH

Selector lever knob with wooden segment

in walnut, dark brown. From quattro GmbH

Selector lever knob in leather

matched to the selected interior colour

Selector lever knob in aluminium look**Audi exclusive leather controls**

steering wheel rim, selector lever and selector lever gaiter available in all Audi exclusive colours; individual choice of colour for stitching in various Audi exclusive colours; stitching on steering wheel rim with Audi exclusive-specific seam detail. From quattro GmbH

Climate control**Auxiliary heating/ventilation**

The auxiliary heating warms up the interior and removes ice from the windows without starting the engine; the auxiliary ventilation system supplies fresh air and reduces the temperature of the interior; with timer and departure time programming (an intelligent control function for time and energy-efficient calculation of heating duration); separate radio-operated remote control with illuminated display; choice of 2 heating modes: “defrost” (defrosting mode only for the windows) and “warm” (warming up mode to additionally preheat the interior)

**Deluxe automatic air conditioning**

- electronically regulates the air temperature, flow rate and distribution
- sunlight-dependent control
- separate temperature distribution for driver and front-passenger side
- ventilation in the rear via the centre console
- recirculation mode
- combined/fine particulate filter
- key-coded settings
- humidity sensor

**4-zone deluxe automatic air conditioning**

In addition to the deluxe automatic air conditioning:

- air conditioning controls with digital display
- additional air conditioning controls with digital display for climate control in the rear with separately adjustable temperature and blower settings and air distribution for the right- and left-hand sides (rear functions can also be set from the front air conditioning controls);
- additional air vents in the B pillars
- automatic recirculation mode by means of air quality sensor
- residual heat
- separate regulation of footwell temperature
- ventilated glove compartment
- choice of 3 climates: gentle, medium, intensive

Luggage securing and storage systems**Storage compartments**

storage compartment in door and side panel trims, including bottle holder, storage net on the front seat backrests, storage compartment under the front seats (not in conjunction with comfort seats, front)

Glove compartment

on the front-passenger side, lockable, large, with light and holder for writing utensils

Storage package

2 cup holders in the rear centre armrest, luggage net for securing objects on the lashing points on the luggage compartment floor, additional 12V socket in the rear

Cup holders

2, integrated into the centre console

Bag hooks

on the left- and right-hand sides of the luggage compartment

Reversible mat

for luggage compartment, velour on one side, rubber on the other, folds out to cover the luggage compartment, even with the rear seats folded down

Through-loading facility

for practical transportation of long objects

Through-loading facility

with removable ski/snowboard bag
removable, secured by a strap, for practical transportation of long items, e.g. up to 4 pairs of skis or 2 snowboards.

Luggage securing and storage systems**Luggage compartment**

large-volume with large through-loading width; includes side net on the right-hand side; 4 lashing points on the luggage compartment floor, with 12V socket; luggage compartment cover

Further interior equipment**Floor mats, front**

velour, coordinated with the selected interior colour

Floor mats, front and rear

velour, coordinated with the selected interior colour

Audi exclusive floor mats

Individual choice of colour for floor mats and piping from the range of Audi exclusive colours.
From quattro GmbH

Audi exclusive carpet and floor mats

Individual choice of colour for carpets, floor mats and piping from the range of Audi exclusive colours.
From quattro GmbH

Pedals and footrest in aluminium look**Door sill trims with aluminium inlays**

on the door sills; S7 logo with S7 Sportback

Aluminium look in the interior

in the interior on light switches, air conditioning, MMI rotary/push-button control, vents and around the selector lever gaiter

Cigarette lighter and ashtray

illuminated, front and rear

Non-smoker version

instead of the cigarette lighter, a storage compartment, front, and a 12V socket in the rear

MMI® and navigation systems**MMI® radio**

- MMI control concept, comprising an electrically extending 6.5-inch colour display and separate MMI control panel
- CD player (MP3, WMA capable)
- radio with phase diversity
- 8 passive loudspeakers at front and rear, total output 80 watts

MMI® radio plus

- MMI control concept, comprising an electrically extending 6.5-inch colour display, separate MMI control panel and car menu
- driver information system
- CD player and 2 SDHC memory card readers (up to 32 GB), both MP3, WMA and AAC capable, AUX-IN connection
- radio with phase diversity, TP memo (automatically saves traffic news when driving)
- Bluetooth interface with Bluetooth audio streaming
- Audi sound system
- for S7 Sportback with quattro logic buttons in aluminium look in the MMI control panel

MMI® and navigation systems**MMI® navigation**

- with navigation data (SD card)¹
- 6.5-inch colour display with high-quality map representation and numerous detailed display options
- dynamic route guidance with TMC (where available)
- voice control (entry of destination by means of whole-word input)
- additional arrow display in the driver information system
- MMI radio plus
- CD player
- 2 SDHC memory card readers (for up to 32 GB)
- Bluetooth interface with Bluetooth audio streaming
- Audi sound system
- for S7 Sportback with quattro logic buttons in aluminium look in the MMI control panel

MMI® navigation plus with MMI touch

- with navigation data (hard drive)¹
- high-resolution 8-inch colour display with high-quality map display and topographical map colouring, display of lots of sightseeing information and city models in 3D; choice of 3 alternative routes, scrolling along selected route and manoeuvring within the map
- split-screen route information (manoeuvring points, points of interest on motorways, TMCpro on route), detailed junction map, motorway exits and lane recommendations also in driver information system, dynamic route guidance with TMCpro (where available)
- vehicle support and speed limit display based on navigation data function
- voice control system (whole-word entry of address in one sentence)
- spoken TMCpro reports
- driver information system with 7-inch colour display
- MMI radio plus
- hard drive for music storage (20 GB)
- DVD drive (MP3, WMA, AAC and MPEG-4 capable)
- 2 SDHC memory card readers (for up to 32 GB)
- Bluetooth interface with Bluetooth audio streaming
- Audi sound system
- for S7 Sportback with quattro logic buttons in aluminium look in the MMI control panel

The use of services supported by Audi connect such as e.g. navigation by means of Google Earth™ map service² and Google Street View™², weather, news, traffic information online is possible in combination with Audi connect including car phone.

MMI® touch

part of MMI navigation plus; touch-sensitive control panel for intuitive operation of the MMI; letters and numbers can be entered without drivers taking their eyes off the road; contextual entry of letters and numbers for navigation destinations via handwriting recognition, selection from address book or entry of telephone numbers with acoustic acknowledgement, simple movement of navigation map and selection of points of interest; retrieval of 6 freely assignable radio station presets

Vehicle support based on navigation data

network technology thanks to Audi connect. Part of MMI navigation plus with MMI touch; adaptation of transmission, light and – if installed – adaptive cruise control with Stop&Go function or adaptive light using route data stored in the navigation system such as the sweep of bends and corners or road classifications, e.g. use of vehicle lighting according to surroundings (urban area, extra-urban areas, motorways and intersections); system also available when navigation is deactivated

**Driver information system**

part of MMI radio plus and MMI navigation, with white 5-inch TFT monochrome display located directly in driver's field of vision, displays the radio frequency, station name or track title and other data from the MMI system such as navigation, GPS clock or telephone menu (if fitted), display of trip computer with long and short term memory, including a graphic consumption display, digital speedometer, door/passenger compartment open warning indicator. The integrated efficiency program further provides assistance in the form of consumption data overviews, a display of additional consumers and fuel-saving tips for a more economical driving style; operated via a leather-covered multifunction steering wheel, incl. attention assist

Centre display

with monochrome readout for ambient temperature, range and radio frequency, gear display, service indicator, oil pressure, brake fault, coolant level/temperature, brake pad wear, door-open pictogram, fuel level warning

MMI® and navigation systems**Driver information system with 7-inch colour display**

part of MMI navigation plus with MMI touch; high resolution TFT colour display in the direct field of view of the driver; displays, in addition to driver information system, information from driver assistance systems, the media being used, outside temperature and other display content of the MMI system, such as – if fitted – navigation, night vision assistant and telephone menu. The integrated efficiency program further provides assistance in the form of consumption data overviews, a display of additional consumers, an enlarged gear display and fuel-saving tips for a more economical driving style; very clearly arranged with easily readable header and status lines (tab concept) and automatic brightness adjustment; operated via a leather-covered multifunction steering wheel; including attention assist

Attention assist

Part of the driver information system; the attention assist analyses driving behaviour using a range of sensors. Steering movements and pedal actuation, for example, are recorded and compared with the individual driving patterns of the respective driver. If the evaluation indicates that the driver's attention is lapsing, the system recommends a break by means of a display in the driver information system and an acoustic signal. The system is active between 65 km/h and 200 km/h and can be deactivated at any time.

Radio and TV systems**Digital Audio Broadcasting**

receives programmes from digitally broadcast radio stations in addition to the range of analogue stations, with better sound quality according to DAB standard, including DAB+ and DMB audio. Display of additional information accompanying the programme (e.g. artist, title, cover) in the form of a slide show and other programme-independent data services (e.g. weather, traffic, news). In conjunction with MMI navigation plus with MMI touch, a second DAB tuner permanently searches for alternative reception frequencies of the set radio station; at the same time the station list is updated. Please note: reception depends on local digital network availability; contents and scope of the additional information depend on provision by the respective radio section.

Digital TV reception

reception of digitally broadcast (DVB-T), uncoded television stations (MPEG-2 or MPEG-4 standard), supports DVB-T audio stations, teletext and Electronic Programme Guide (EPG). External AV-IN connection via adapter cable (available through Audi Genuine Accessories). Please note: TV reception depends on digital network availability; no picture possible when the vehicle is moving

Preparation for Rear Seat Entertainment

includes pre-installed wiring and mounts for the holders in the driver and front-passenger seat backrests. The appropriate Audi Entertainment mobile (9-inch screen with integrated DVD player) and the holder are available as a plug-and-play unit from Audi Genuine Accessories (see also page 102).

**Bang & Olufsen Advanced Sound System**

surround sound reproduction with 15 loudspeakers including subwoofer and centre speaker, each with its own amplifier channel; automatically extending acoustic lenses for excellent sound performance and perspective from every seat; 10-channel DSP all-digital amplifier; all-digital highly efficient 5-channel ICE Power amplifiers for tweeters and subwoofers; with total output of over 1,200 watts; polished loudspeaker covers in aluminium; privacy function: encapsulated loudspeaker casings minimise escape of sound to the outside of the vehicle and provide privacy, for example when making telephone calls in hands-free mode; a precisely defined loudspeaker effect has also been achieved; noise-dependent volume adjustment. Reproduction of 5.1 surround sound is possible.

Audi sound system

part of MMI radio plus, MMI navigation and MMI navigation plus with MMI touch; 10 loudspeakers including centre speaker in the dashboard and subwoofer in the spare wheel well, 6-channel amplifier, with a total output of 180 watts

**BOSE Surround Sound**

Surround sound reproduction with 14 speakers including centre speaker in the dashboard and subwoofer in the spare wheel well; 12-channel amplifier with over 600 watts of total output; powerful and accurate bass reproduction, lifelike sound with natural tone and a feeling of space for an impressive sound experience; sound system very well matched to the interior acoustics of the vehicle; AudioPilot® for noise-dependent volume adjustment. Reproduction of 5.1 surround sound is possible in conjunction with MMI navigation plus with MMI touch.

CD changer

in the glove compartment, for 6 CDs (MP3 and WMA compatible), vibration-proof, each CD can be loaded and changed individually. Music files with digital rights management (DRM) cannot be played.

DVD/CD changer

in the glove compartment, for 6 DVDs or CDs, supports e.g. audio CDs, video DVDs and MP3, WMA, AAC, MPEG4 and playlists; shock-resistant; DVDs and CDs can be changed individually, supports up to 4,000 tracks per medium. Music files with digital rights management (DRM) cannot be played.

Radio and TV systems



Audi music interface

for connection of portable media players such as Apple iPod generation 4 and higher, Apple iPhone (music functionality) as well as USB storage media and MP3 players. The Audi music interface is housed in the centre console; it is operated via MMI or leather-covered multifunction steering wheel. Note: can only be used in conjunction with a special adapter cable (available from Audi Genuine Accessories). Please contact your Audi partner or visit www.audi.com/mp3 for information on compatibility. If Audi music interface is ordered the separate AUX-IN connection is omitted.

Adapter cable set for Audi music interface

consisting of 2 connection cables to connect iPod/iPhone or data storage devices/media players with USB port (type A); other adapter cables available from Audi Genuine Accessories; please contact your Audi partner or visit www.audi.com/mp3 for information on compatibility.

Adapter cable set plus for Audi music interface

in addition to the adapter cable set for Audi music interface support for the representation of cover arts, video function, etc.; depends on the end device used; please contact your Audi partner or visit www.audi.com/mp3 for information on compatibility.

Telephone and communication

Audi connect including car phone

convenient connection of your vehicle to the internet. Use of the services supported by Audi connect is possible only with the optional MMI navigation plus equipment and with the data module integrated in Audi connect including car phone. You also require a SIM card with a data option – for car phone a SIM card with phone and data option or a Bluetooth-capable smartphone with remote SIM Access Profile (rSAP). There is a reader for your SIM card in the surround of the MMI navigation plus.

The following **services** supported by **Audi connect** are available in your model:

Mobility & navigation

- Point-of-interest (POI) search with voice control
- Traffic information online
- Navigation with Google Earth™ map service* and Google Street View™**
- Destination entry via myAudi or Google Maps™**
- Fuel prices
- Parking information
- Country information

Communication

- Wi-Fi hotspot

Infotainment

- Weather
- Audi music stream
- News online
- City events
- Travel information

The services are available only with an existing or separate mobile phone contract and only within the range of the respective mobile phone network. Additional costs may be incurred when receiving data packets from the internet, depending on the terms of your mobile phone contract, particularly when used abroad. Because of the high data volumes involved, a data flat rate is strongly recommended.

The availability of the services supported by Audi connect varies from country to country. The services are provided for at least one year from vehicle delivery. The traffic information online service requires initial activation in the vehicle. From that point onwards, this service is subject to a 36-month usage limit (in as far as activation takes place within 6 months of vehicle delivery; otherwise corresponding shortening of the usage rights). Your Audi partner will be happy to inform you about how to extend the service and the costs this incurs.

Please visit www.audi.com/connect or contact your Audi partner for more detailed information about Audi connect; contact your mobile services provider for information about contract conditions.



Handset in the front for car phone

wireless handset with colour display and integrated SIM card reader, for making private phone calls; easy writing of text messages thanks to automatic word recognition; handset is stored in the centre armrest, front

Preparation for mobile phone (Bluetooth)

includes a hands-free facility and voice control for telephone functions as well as a preparation for an optional mobile-specific charger in the front centre console; including connection to the vehicle aerial for reduced SAR radiation inside the vehicle and better reception quality; operation via the radio/navigation systems or a leather-covered multifunction sport steering wheel. Please contact your Audi partner or visit www.audi.com/bluetooth for adapters and information on compatible mobile phones.

Bluetooth interface

part of MMI radio plus, MMI navigation and MMI navigation plus with MMI touch; Bluetooth-compatible mobile phones can be connected to the vehicle via the interface; hands-free calls in the vehicle possible via the microphone; including Bluetooth audio streaming (depending on mobile phone compatibility). Please contact your Audi partner or visit www.audi.com/bluetooth for information on compatible mobile phones.

Assistance systems

Audi pre sense basic

Networking the different vehicle systems enables driving situations to be categorised and, where necessary, actions to be implemented for preventive occupant protection. These include: belt tensioner, activating the hazard warning system and closing the windows and – if fitted – sliding roof

adaptive cruise control with Stop&Go function including Audi pre sense front

automatic distance control (control range 0–250 km/h); working within system limits, it uses 2 radar sensors and a camera to detect vehicles ahead and maintains the distance by automatic braking and accelerating; independent braking to a stop, automated restart at driver's request; 4 distance levels and 4 driving modes (efficiency, comfort, dynamic and standard) can be selected individually. The use of Audi connect services is possible in conjunction with MMI navigation plus with MMI touch: the navigation system stores route data such as the sweep of bends and corners or road classifications allowing comfortable distance control, for instance when driving the same winding roads once again. In addition to the functions of Audi pre sense basic, **Audi pre sense front** implements preventive occupant protection measures when threatened with an imminent frontal collision; includes Audi braking guard with driver warning through an extended brake assist feature and preventive occupant protection. Working within system limits, Audi pre sense front uses the front sensors of adaptive cruise control with Stop&Go function for the detection. Extended by the function of maximum deceleration: this is initiated at speeds below 30 km/h if there is a danger of collision with a stationary or moving vehicle in order to reduce the severity of the collision or to avoid this collision if possible.

Cruise control

at speeds of 30 km/h to 250 km/h and above, the system keeps the set speed constant, provided that engine power and engine braking effect permit it; operated via separate steering column stalk, set speed displayed in driver information system



Audi side assist including Audi pre sense rear

lane change assistant, within system limits, assists the driver when changing lanes (operating range 30–250 km/h). Displays are incorporated into both exterior mirrors. Audi side assist uses 2 radar sensors to measure the vehicle's distance from other vehicles it has detected as well as the speed difference between them. If Audi side assist deems that the speed difference and distance will compromise a lane change, a display will appear in the respective exterior mirror. In addition to the functions of Audi pre sense basic, **Audi pre sense rear**, working within system limits, uses the rear sensors of Audi side assist to detect a possible rear-end collision.

Audi active lane assist

lane compliance assistant; supports the driver within system limits comfortably in keeping in the lane (operating range 60–250 km/h); if the system is activated and ready and the driver did not indicate, the Audi active lane assist will guide the vehicle within recognised lane boundary lines by means of gentle, corrective steering intervention; the driver can choose whether he would like to be supported continuously or just shortly before crossing the road marking (choice of earlier or later steering time); additional steering wheel vibration can be adjusted if the driver wishes; additional display in the head-up display (can be ordered as an option)

Assistance package including Audi pre sense plus

The assistance package contains the functions of the following assistance systems:

- adaptive cruise control with Stop&Go function
- Audi active lane assist
- Audi side assist
- parking system plus
- Audi pre sense front
- Audi pre sense rear

The features of Audi pre sense basic, Audi pre sense front and Audi pre sense rear are extended by the function of a maximum deceleration to Audi pre sense plus: in addition to the functions of Audi pre sense front, Audi pre sense plus activates the Audi braking guard in certain situations in which a collision is unavoidable and initiates maximum deceleration to minimise the impact speed of the crash by up to 40 km/h.

Hold assist

holds the vehicle stationary for unlimited periods after stopping on almost all uphill and downhill gradients. The system is activated by push-button and allows the driver to drive away easily and comfortably.



Night vision assistant

with marking of detected pedestrians

with integrated thermal imaging camera; when driving at night, this system extends the driver's range of visibility beyond the light provided by the dipped beam; records thermal images; an image processing algorithm then evaluates the camera's data and highlights any persons it has detected in yellow in the optional driver information system's colour display; the marking changes to red and a warning tone is emitted if the system, by analysing the movement and position of the person it has detected, considers that there is a possible risk. In conjunction with one of the following lighting systems, the person is also illuminated with 3 successive brief flashes of the headlights (marking light): xenon plus in conjunction with high-beam assist, Audi adaptive light including variable headlight range control or LED headlights. Additional warning symbol in the head-up display (can be ordered as an option); image quality is affected by poor ambient conditions

Assistance systems

**Head-up display**

projects as required information relevant to the driver from the assistance systems, navigation or warning symbols onto the windscreen in the driver's direct field of vision; height adjustable; provides a multicoloured display with good contrast and minimal distraction from the road

Camera-based speed limit display

camera based recognition and display of speed limits, including temporary speed limit displays (e.g. above motorways). Additionally, working within system limits, there is an evaluation of the particular situation in wet conditions, and speed limits displayed depending on the time of day, road works and when using a trailer. If a sign has not been recognised by the camera, thanks to Audi connect, the speed limit displayed can be taken from the navigation data (where available). Additional display in the head-up display (can be ordered as an option)

**Parking system plus**

acoustic and visual parking system for the front and rear with MMI display; measurement is by ultrasonic sensors integrated discreetly in the bumpers; can also be ordered with optional reversing camera or front and reversing camera

**Park assist with display of surroundings**

searches for suitable parking space along the road by means of ultrasonic sensors, calculates the ideal parking path for cross parking spaces and for kerb-side parking spaces the ideal path for parking and leaving and performs the steering action almost automatically. Parking is now even possible in smaller parking spaces and curve areas; parking in several moves is supported. Steering is done by the vehicle, while the driver only needs to accelerate and apply the brakes. The display of surroundings warns of obstacles at the side depending on the steering angle and makes parking and leaving a parking space comfortable by providing the correct steering angle; can optionally additionally be ordered with reversing camera or front and reversing camera

Assistance systems

**Reversing camera**

Image of area behind the vehicle shown on the MMI display, with dynamic display modes showing the calculated path (steer-angle dependent); includes auxiliary lines and guidelines and identification of the point at which to apply opposite lock when parallel parking, reversing camera concealed in the handle strip of the luggage compartment lid

Front and reversing cameras

Image of area behind the vehicle shown on the MMI display, with dynamic display modes showing the calculated path (steer-angle dependent); includes auxiliary lines and guidelines and identification of the point at which to apply opposite lock when parallel parking, reversing camera integrated discreetly in the handle strip of the luggage compartment lid, additional display modes for front to the left/right side and rear to the left/right side for safe drive out of tight parking slots, yard entrances or in car parks

Suspensions/brakes

Audi drive select

changes vehicle characteristics, e.g. by adapting power steering assistance, accelerator and gear changing characteristics or adaptive air suspension; modes available: comfort, dynamic, auto, efficiency and individual. The system also influences other optional equipment. The efficiency mode is available for all TFSI and TDI engines and shifts the engine, transmission, adaptive cruise control (optional) and climate control into a consumption-optimised basic setting.

adaptive air suspension

electronically controlled air suspension with infinitely variable adaptive damping system on all 4 wheels; automatically regulates vehicle ride height and damping; includes ride height control; different modes selected via Audi drive select, vehicle ride height lowered by up to 20 mm depending on mode

adaptive air suspension sport

with S-specific tuning: electronically controlled air suspension with infinitely variable adaptive damping system on all 4 wheels, automatically controls vehicle level and damping; 4 modes (auto, comfort, dynamic, and lift) can be selected via MMI; including level control; stiffer damping; vehicle ride height lowered by up to 20 mm depending on mode

Sport suspension

vehicle lowered by 10 mm compared to the standard dynamic suspension with stiffer set suspension and damping for more direct contact with the road and sporty handling

S line sport suspension

with dynamic suspension tuning and vehicle lowered by 20 mm compared to the standard dynamic suspension

Brake system

dual-circuit, diagonally-split brake system with brake booster, Antilock Brake System (ABS), Electronic Brake Force Distribution (EBD) and hydraulic brake assist, ventilated disc brakes front and rear (at the rear from 180 kW), rear brakes with electromechanical parking brake; for S7 Sportback high-performance brake system and black painted brake callipers, at the front additionally with S7 emblem

Electromechanical parking brake

with hold assist; includes parking brake function when stationary, drive-off assistance function through automatic release when driving away and emergency braking function whilst driving acting on all 4 wheels

Ceramic brake*

19-inch high-performance brake system with carbon-fibre reinforced ceramic brake discs front and rear, specially developed cooling channels for the ventilated and perforated brake discs; high-gloss brake callipers, painted in anthracite, with "Audi ceramic" logo at the front

Technology/safety

Body, galvanised

lightweight aluminium hybrid construction; fully galvanised in areas at risk from corrosion, self-supporting, welded to the floor pan, front and rear areas feature defined crumple zones. (12 year guarantee against rust perforation)

Side impact protection

front and rear aluminium impact protection bars integrated into the doors

Child-proof lock

electric child-proof lock on the rear doors, operated via the child-proof lock buttons in the driver's door armrest, additional electric child-proof lock for the rear window controls

Airbags

Full-size airbags for driver and front passenger; in conjunction with ISOFIX child seat mounting for front-passenger seat, including deactivation switch for front-passenger airbag

Side airbags at the front and head airbag system

front side airbags integrated in the seat backrests; with additional head airbag system: unfolds over the side windows and protects front and outer rear passengers in the event of a side impact

Side airbags, rear

supplement the front side airbags and head airbag system

Technology/safety**Integrated head restraint system**

In the event of a rear-end collision, the design of the front seat better restrains the upper torso and supports the head more securely than on conventional systems, thereby increasing safety and reducing the danger of whiplash.

Instrument cluster

with controllable lighting, coolant temperature display, fuel gauge, rev counter with digital clock, speedometer with disproportionate speed display and electronic odometer/trip odometer, displays for radio frequency, ambient temperature and tank range, warning and control lights, maintenance interval display; for S7 Sportback S-specific with grey dials, white needles, S7 logo in the rev counter and automatic ready-check when engine starts

Safety steering column

increases the safety potential of the seat belt and airbag

Seat belts

3-point inertia reel seat belts; reversible seat belt tensioners, adaptive belt forcer limiter and belt height adjustment/belt buckle status query at front; seat belt reminder function for driver and front-passenger seats with acoustic and visual warning signal; belts matched to the interior colour

Audi exclusive seat belts

Choice of colour for seat belt from the Audi exclusive colours. From quattro GmbH

65 l fuel tank**73 l fuel tank****75 l fuel tank****Warning triangle**

with bracket on the inside of the luggage compartment lid

First-aid kit

in the storage compartment in the rear centre armrest

Antilock Brake System (ABS)

with Electronic Brake Force Distribution (EBD) and hydraulic brake assist

Anti-Slip Regulation (ASR)

for good traction and lateral stability, reduces spinning of the drive wheels

Electronic Differential Lock (EDL)

On surfaces with varying levels of grip, this start-off assistant automatically brakes the drive wheels on the surface that is too slippery, thereby ensuring smooth, powerful progress.

Electronic Stabilisation Control (ESC)

networks the ABS, EBD, ASR and EDL with its own sensors and compares the driving data with reference data; provides better stability through targeted braking of individual wheels and intervention in the engine management system

Electronic Stabilisation Control (ESC)**with electronic axle-differential lock**

integrated in ESC; modifies driving force by means of targeted braking actions depending on the driving situation; when cornering the electronic axle-differential lock ensures smooth and precise handling with no understeer; improved traction and dynamic performance when cornering. (For models with front-wheel drive)

Electromechanical power steering

maintenance-free rack & pinion steering with speed-dependent power steering; precise steering feel at high speeds, excellent assistance when parking; active countersteering provides steering assistance to the driver for enhanced vehicle stability

Dynamic steering

when changing lanes, parking and cornering, this system improves comfort and handling by dynamically regulating steering according to the driving situation. In addition to adaptation of the steering effort (as with the electromechanical power steering), the steering angle is also adapted (steering ratio). The system is also supported further by vehicle stabilisation through ESC.

multitronic®

the multitronic generation of continuously variable transmissions, featuring dynamic gear control program (DCP) and sport program; 8 different gears can be selected in manual mode; hydraulically controlled multi-plate clutch. (For models with front-wheel drive)

S tronic®

The 7-speed dual-clutch transmission with electrohydraulic actuation facilitates shorter gear changing and with hardly any perceptible break in propulsive power: can be operated via the shift paddles behind the steering wheel or the selector lever; in automatic mode the driver can choose between 2 programs D (normal) and S (sport). (For models with quattro drive)

tiptronic

8-speed automatic transmission with Dynamic Shift Program (DSP) and sport program; option of manual control via shift paddles on the leather-covered multifunction steering wheel or by briefly touching the selection lever

quattro®

permanent all-wheel drive with asymmetric/dynamic torque distribution, self-locking centre differential and wheel-selective torque distribution; distributes the driving forces depending on the driving situation to each individual wheel for precisely controlled handling

quattro® with sport differential

The electronically regulated sport differential distributes variable amounts of driving force to each rear wheel and ensures outstanding acceleration performance in corners and stabilises the vehicle's response to load change; also improves direct steering characteristics and provides more agile handling due to the lower steering effort required.

Recuperation

Increasing the generator voltage converts kinetic energy into usable electrical energy when the vehicle is coasting or braking. This brake energy recovery is then used to assist the generator during subsequent acceleration, saving up to 3 % fuel.

Start-stop system

helps to reduce fuel consumption and CO₂ emissions by switching off the engine in stationary phases, e.g. at traffic lights. The start process is initiated as soon as the foot brake is released for the vehicle to move off again. Can be deactivated at any time via a button.

Technology/safety**Audi TDI clean diesel**

In addition to the standard equipment with catalytic converter and diesel particulate filter, the new exhaust aftertreatment system installed in the model with TDI clean diesel leads to low exhaust emissions. Nitrogen oxides are reduced by the innovative nitrogen oxide catalytic converter (DeNOx catalytic converter) at the end of the exhaust pipe. A pump injects tiny quantities of the biologically degradable additive AdBlue®*. This solution then decomposes in the hot exhaust flow to form ammonia, which splits the nitrogen oxides into nitrogen and water. This splitting is called selective catalytic reduction (SCR). Refill the separate AdBlue tank as indicated by the information in the display of the instrument cluster. We recommend having the AdBlue tank refilled by your Audi partner (about every 15,000 km).

Active Noise Cancellation

The Active Noise Cancellation system can compensate noises from individual frequencies depending on the engine speeds.

Audi Extended Warranty**Audi Extended Warranty**

can be ordered directly and exclusively when you purchase a new vehicle; consistently continues the manufacturer's guarantee and thus offers lasting protection against risk and service cost control even beyond the first 2 years. Choice of 9 service life/total mileage combinations:

Additional 1 year Audi Extended Warranty, maximum total mileage 30,000 km

Additional 1 year Audi Extended Warranty, maximum total mileage 60,000 km

Additional 1 year Audi Extended Warranty, maximum total mileage 90,000 km

Additional 2 years Audi Extended Warranty, maximum total mileage 40,000 km

Additional 2 years Audi Extended Warranty, maximum total mileage 80,000 km

Additional 2 years Audi Extended Warranty, maximum total mileage 120,000 km

Additional 3 years Audi Extended Warranty, maximum total mileage 50,000 km

Additional 3 years Audi Extended Warranty, maximum total mileage 100,000 km

Additional 3 years Audi Extended Warranty, maximum total mileage 150,000 km

Audi Genuine Accessories: nothing is more inspiring than remaining true to yourself.

The Audi A7 Sportback defines a new vehicle class by uniting the elegance of a Saloon, the functionality of an Avant and the emotion of a Coupé. Then there is only one thing missing: your personality. With Audi Genuine Accessories, you can design your A7 Sportback just as you want it. The following pages contain a small selection from the extensive range of Audi Genuine Accessories on offer.



Detailed information can be obtained from the Audi A7 Sportback accessories catalogue, at www.audi.com, and from your Audi partner.





1 2

1 Ski and luggage box (450 l)¹

Lockable and can be opened from both sides. Suitable for skis up to 2.10 m. Also available with a capacity of 480 l or as a compact luggage box with a capacity of 370 l. Maximum permissible load 50 kg. (Can only be used in conjunction with the carrier unit.)

2 Cast aluminium wheels in 5-arm parabola design, high-gloss turned finish, anthracite

Exceptional design, perfectly matched to your A7 Sportback. With high-gloss turned arms. In size 9 J x 20 for 265/35 R 20 tyres.

3 Cast aluminium winter wheels in 5-V-spoke design

Striking complete winter wheel in extravagant design. Can be fitted with snow chains, in size 8 J x 19 for 235/45 R 19 tyres². Snow chains are available from Audi Genuine Accessories.

4 Carrier unit

Carrier unit for various roof rack modules such as cycle rack, kayak rack or ski and luggage box. The profile section is made from anodised aluminium tube. The carrier unit is easy to install and lockable. Maximum permissible total weight of carrier, modules and load 90 kg.

5 Audi Entertainment mobile

9-inch screen with integrated DVD player for installation on the front seat backrests. Excellent image quality thanks to digital high resolution screen, high functionality and numerous connection options, e.g. the separately available Bluetooth headset. With the new holder for mobile end devices, it is easy to attach and can also be used outside the vehicle. Requires preparation for Rear Seat Entertainment in the vehicle.

6 Luggage compartment liner

Tailor-made protection for the luggage compartment. Washable and sturdy. The edge protects the luggage compartment floor better from leaked liquids.

7 Audi tracking system plus³

enables a stolen vehicle to be located and tracked via GPS/GSM technology in 27 European countries. With automatic driver recognition and intelligent restart inhibitor.

Audi child seat youngster plus

offers excellent comfort thanks to intelligent belt guidance. The backrest is adjustable in height and width. Adaptations can be made via a viewing window for size adjustment. Suitable for children from 15 to 36 kg (approx. 4 to 12 years). Also available: the Audi baby seat suitable for small children up to 13 kg (approx. 12 months) and the Audi child seat for children from 9 to 18 kg (approx. 12 months to 4 years). The ISOFIX-Basis, which is separately available, can optionally be used for the Audi baby seat and is strictly required for the Audi child seat.



3



4



5



6



7

¹The opening of the vehicle tailgate is restricted during use. ²You will find specifications on the technical characteristics of tyres on page 107.

³For more detailed information, please contact your Audi partner.

| Model | A7 Sportback 2.8 FSI (150 kW) | A7 Sportback 2.8 FSI quattro (150 kW) | A7 Sportback 3.0 TFSI quattro (228 kW) | A7 Sportback 3.0 TDI (150 kW) |
|---|--|--|--|--|
| Engine type | V6 cylinder petrol engine with direct fuel injection and Audi valvelift system | V6 cylinder petrol engine with direct fuel injection and Audi valvelift system | V6 cylinder petrol engine with direct fuel injection and mechanical supercharger | V6 cylinder diesel engine with common rail injection system and turbocharging |
| Displacement in cc³ (valves per cylinder) | 2773 (4) | 2773 (4) | 2995 (4) | 2967 (4) |
| Max. output ¹ in kW at rpm | 150/5250-6500 | 150/5250-6500 | 228/5500-6500 | 150/3750–4500 |
| Max. torque in Nm at rpm | 280/3000-5000 | 280/3000-5000 | 440/2900–4500 | 400/1250-3500 |
| Power transmission/wheels | | | | |
| Drive type | Front-wheel drive | quattro® permanent all-wheel drive | quattro® permanent all-wheel drive | Front-wheel drive |
| Transmission type | multitronic | 7-speed S tronic | 7-speed S tronic | multitronic |
| Wheels | Forged aluminium wheels, 8 J x 17 | Forged aluminium wheels, 8 J x 17 | Forged aluminium wheels, 8 J x 17 | Forged aluminium wheels, 8 J x 17 |
| Tyres | 235/55 R 17 ² | 235/55 R 17 ² | 235/55 R 17 ² | 235/55 R 17 ² |
| Weights/capacities | | | | |
| Unladen weight ³ in kg | 1735 | 1805 | 1860 | 1770 |
| Gross vehicle weight in kg | 2270 | 2340 | 2395 | 2305 |
| Permissible roof load limit/nose weight in kg | 100/85 | 100/85 | 100/85 | 100/85 |
| Trailer load limit ⁴ in kg | unbraked <p>12 % gradient</p> <p>8 % gradient</p> 750 <p>1900</p> 2100 | unbraked <p>12 % gradient</p> <p>8 % gradient</p> 750 <p>1900</p> 2100 | unbraked <p>12 % gradient</p> <p>8 % gradient</p> 750 <p>2100</p> 2100 | unbraked <p>12 % gradient</p> <p>8 % gradient</p> 750 <p>1800</p> 1900 |
| Fuel tank capacity, approx. in l | 65 | 65 | 65 | 65 |
| Performance/consumption ⁵ | | | | |
| Top speed in km/h | 235 | 235 | 250 ⁶ | 235 |
| Acceleration 0–100 km/h in s | 7.9 | 8.3 | 5.6 | 7.4 |
| Fuel grade | Sulphur-free super RON 95 ⁷ | Sulphur-free super RON 95 ⁷ | Sulphur-free super RON 95 ⁷ | Sulphur-free diesel ⁸ |
| Fuel consumption ⁹ in l/100 km | urban <p>extra-urban</p> <p>combined</p> 9.6 <p>6.1</p> 7.4 | urban <p>extra-urban</p> <p>combined</p> 10.7 <p>6.5</p> 8.0 | urban <p>extra-urban</p> <p>combined</p> 10.8 <p>6.6</p> 8.2 | urban <p>extra-urban</p> <p>combined</p> 5.9 <p>4.7</p> 5.1 |
| CO ₂ emission ⁹ figures in g/km | urban <p>extra-urban</p> <p>combined</p> 224 <p>142</p> 172 | urban <p>extra-urban</p> <p>combined</p> 249 <p>151</p> 187 | urban <p>extra-urban</p> <p>combined</p> 252 <p>153</p> 190 | urban <p>extra-urban</p> <p>combined</p> 154 <p>124</p> 135 |
| Emission standard | EU5 | EU5 | EU5 | EU5 |

| Model | A7 Sportback 3.0 TDI quattro (150 kW) | A7 Sportback 3.0 TDI quattro (180 kW) | A7 Sportback 3.0 TDI clean diesel quattro (180 kW) ¹⁰ | A7 Sportback 3.0 TDI quattro (230 kW) |
|---|--|--|--|--|
| Engine type | V6 cylinder diesel engine with common rail injection system and turbocharging | V6 cylinder diesel engine with common rail injection system and turbocharging | V6 cylinder diesel engine with common rail injection system and turbocharging | V6 cylinder diesel engine with common rail injection system and turbocharging |
| Displacement in cc³ (valves per cylinder) | 2967 (4) | 2967 (4) | 2967 (4) | 2967 (4) |
| Max. output ¹ in kW at rpm | 150/3250–4500 | 180/4000–4500 | 180/4000–4500 | 230/3900–4500 |
| Max. torque in Nm at rpm | 450/1250-3000 | 580/1400-3250 | 580/1750-2500 | 650/1450-2800 |
| Power transmission/wheels | | | | |
| Drive type | quattro® permanent all-wheel drive | quattro® permanent all-wheel drive | quattro® permanent all-wheel drive | quattro® permanent all-wheel drive |
| Transmission type | 7-speed S tronic | 7-speed S tronic | 7-speed S tronic | 8-speed tiptronic |
| Wheels | Forged aluminium wheels, 8 J x 17 | Forged aluminium wheels, 8 J x 17 | Forged aluminium wheels, 8 J x 17 | Forged aluminium wheels, 8 J x 17 |
| Tyres | 235/55 R 17 ² | 235/55 R 17 ² | 235/55 R 17 ² | 235/55 R 17 ² |
| Weights/capacities | | | | |
| Unladen weight ³ in kg | 1860 | 1860 | 1895 | 1925 |
| Gross vehicle weight in kg | 2395 | 2395 | 2430 | 2460 |
| Permissible roof load limit/nose weight in kg | 100/85 | 100/85 | 100/85 | 100/85 |
| Trailer load limit ⁴ in kg | unbraked <p>12 % gradient</p> <p>8 % gradient</p> 750 <p>1800</p> 1900 | unbraked <p>12 % gradient</p> <p>8 % gradient</p> 750 <p>2000</p> 2100 | unbraked <p>12 % gradient</p> <p>8 % gradient</p> 750 <p>2000</p> 2100 | unbraked <p>12 % gradient</p> <p>8 % gradient</p> 750 <p>2100</p> 2100 |
| Fuel tank capacity, approx. in l | 65 | 65 | 73 | 65 |
| Performance/consumption ⁵ | | | | |
| Top speed in km/h | 235 | 250 ⁶ | 250 ⁶ | 250 ⁶ |
| Acceleration 0–100 km/h in s | 7.2 | 6.3 | 6.4 | 5.3 |
| Fuel grade | Sulphur-free diesel ⁸ | Sulphur-free diesel ⁸ | Sulphur-free diesel ⁸ | Sulphur-free diesel ⁸ |
| Fuel consumption ⁹ in l/100 km | urban <p>extra-urban</p> <p>combined</p> 6.8 <p>5.1</p> 5.8 | urban <p>extra-urban</p> <p>combined</p> 7.2 <p>5.2</p> 5.9 | urban <p>extra-urban</p> <p>combined</p> 7.3 <p>5.1</p> 5.9 | urban <p>extra-urban</p> <p>combined</p> 7.9 <p>5.5</p> 6.3 |
| CO ₂ emission ⁹ figures in g/km | urban <p>extra-urban</p> <p>combined</p> 179 <p>135</p> 152 | urban <p>extra-urban</p> <p>combined</p> 188 <p>138</p> 156 | urban <p>extra-urban</p> <p>combined</p> 192 <p>134</p> 156 | urban <p>extra-urban</p> <p>combined</p> 207 <p>143</p> 166 |
| Emission standard | EU5 | EU5 | EU6 | EU5 |

| Model | S7 Sportback 4.0 TFSI quattro (309 kW) | |
|---|--|---------------------|
| Engine type | V8 cylinder petrol engine with direct fuel injection and Audi valvelift system | |
| Displacement in cc ³ (valves per cylinder) | 3993 (4) | |
| Max. output ¹ in kW at rpm | 309/5500–6400 | |
| Max. torque in Nm at rpm | 550/1400–5200 | |
| Power transmission/wheels | | |
| Drive type | quattro® permanent all-wheel drive | |
| Transmission type | 7-speed S tronic | |
| Wheels | Cast aluminium wheels in 5-parallel-spoke design (S design), 8.5 J x 19 | |
| Tyres | 255/40 R 19 ² | |
| Weights/capacities | | |
| Unladen weight ³ in kg | 2020 | |
| Gross vehicle weight in kg | 2555 | |
| Permissible roof load limit/nose weight in kg | 100/85 | |
| Trailer load limit ⁴ in kg | unbraked 12% gradient 8% gradient | 750 2100 2100 |
| Fuel tank capacity, approx. in l | 75 | |
| Performance/consumption ⁵ | | |
| Top speed in km/h | 250 ⁶ | |
| Acceleration 0–100 km/h in s | 4.7 | |
| Fuel grade | Sulphur-free super RON 95 ⁷ | |
| Fuel consumption ⁹ in l/100 km | urban extra-urban combined | 13.4 7.5 9.6 |
| CO ₂ emission ⁹ figures in g/km | urban extra-urban combined | 312 174 225 |
| Emission standard | EU5 | |

Explanatory notes

¹ The figure given was calculated using the specified measuring procedure (current version of Directive 80/1269/EEC).

² You will find specifications on the technical characteristics of tyres in the adjacent table.

³ Unladen vehicle weight includes driver (68 kg), 7 kg of luggage and fuel tank 90% full, calculated in accordance with the current version of EC Directive 92/21/EEC. Optional equipment may increase the car's unladen weight and drag coefficient, whereupon the possible payload limit and the top speed will be reduced accordingly.

⁴ The engine's power output always decreases with increasing altitude. At 1,000 m above sea level, and for every additional 1,000 m, deduct 10% from the weight of the outfit (trailer load limit + gross weight of the towing vehicle). Figure for trailer load limit applies to factory-fitted trailer towing hitch. If using the vehicle with a trailer towing hitch for commercial purposes, a digital tachograph may be required under certain conditions.

⁵ A vehicle's fuel consumption and CO₂ emissions do not just depend on how efficiently the vehicle uses the fuel, but are also influenced by driving behaviour and other non-technical factors. CO₂ is the greenhouse gas primarily responsible for global warming.

⁶ Regulated.

⁷ We recommend using sulphur-free super unleaded RON 95 in accordance with DIN EN 228. If this is not available, use sulphur-free regular unleaded RON 91 in accordance with DIN EN 228; power output will be slightly reduced. Unleaded RON 95 fuel with a maximum ethanol content of 10% (E10) can generally be used. Fuel consumption details refer to operation with RON 95 fuel in accordance with 692/2008/EC.

⁸ We recommend using sulphur-free diesel in accordance with DIN EN 590. If this is not available, use diesel in accordance with DIN EN 590.

⁹ The figures given were calculated using the specified measuring procedures. The figures do not refer to one individual vehicle and do not form part of any offer, but rather should be used purely for purposes of comparison between the different vehicle models.

¹⁰ Refill the separate AdBlue tank as indicated by the information in the display of the instrument cluster. We recommend having the AdBlue tank refilled by your Audi partner (about every 15,000 km).

Important note

Inspections are due as shown by the service display.

Classifications of tyre parameters

The table shows the range of fuel efficiency, wet grip and exterior noise emission classes for the different tyre sizes of the Audi A7 Sportback and Audi S7 Sportback.

| | Tyre size | Fuel efficiency class | Wet grip class | Exterior noise emission class | |
|--------------|-------------|-----------------------|----------------|-------------------------------|---|
| Summer tyres | 235/55 R 17 | E–C | C–A | 71–67 | - |
| | 255/45 R 18 | E–C | C–A | 72–69 | - |
| | 255/40 R 19 | E–C | C–A | 73–69 | - |
| | 265/35 R 20 | E | C–A | 73–69 | - |
| Winter tyres | 275/30 R 21 | E | B | 73–70 | - |
| | 235/55 R 17 | E | E–C | 72–70 | |
| | 235/45 R 19 | E | E–C | 72–70 | - |
| | 265/35 R 20 | E | C | 70 | |

It is not possible to order a specific tyre.



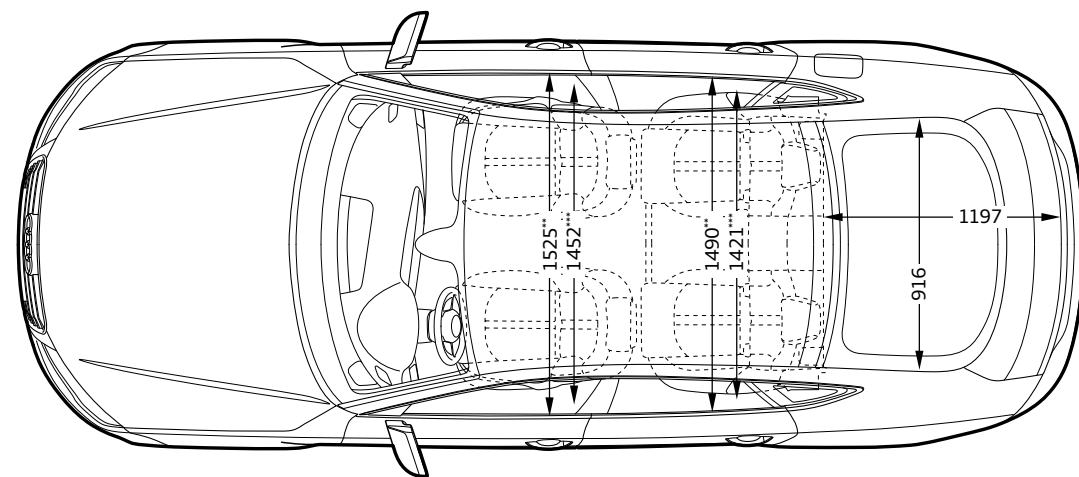
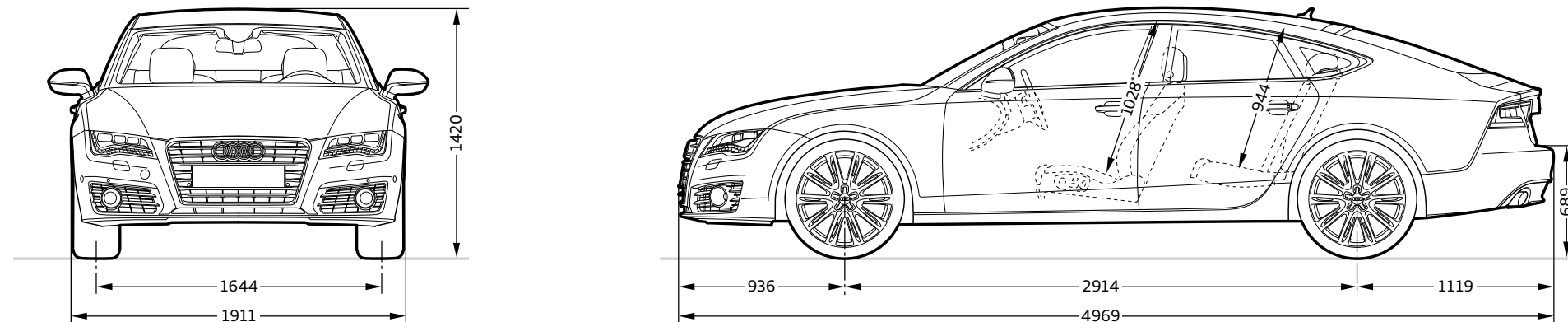



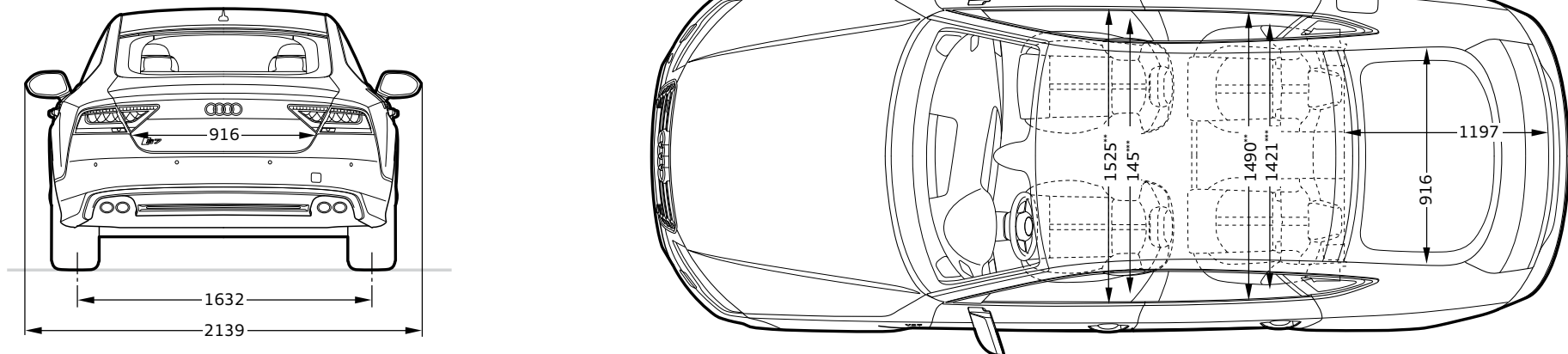
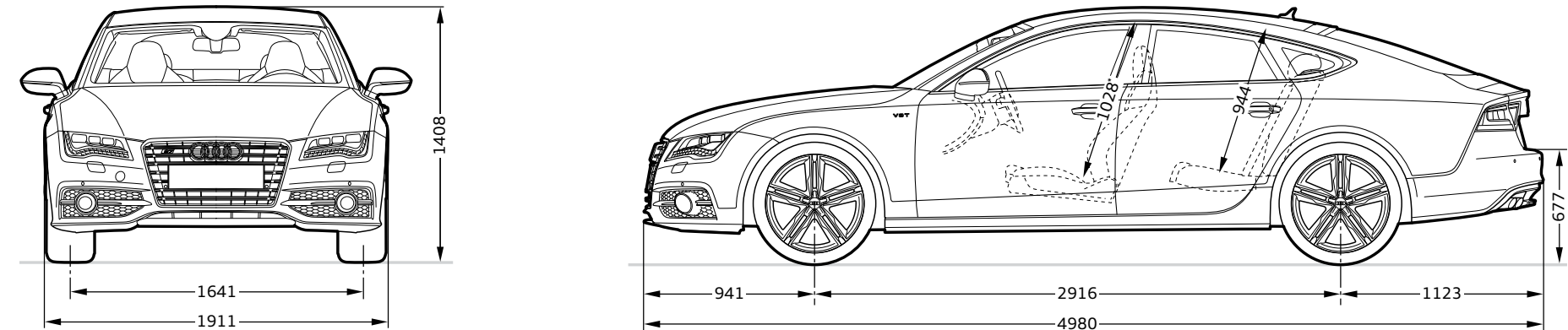







Ask your Audi partner about the range of tyres available in your country.



















Dimensions in millimetres.
Dimensions were measured with vehicle at unladen weight.
Luggage compartment volume 535/1390 l (measured by the VDA standard test method using 200 x 100 x 50 mm blocks; second value is with the rear seat backrest folded down and the vehicle loaded up to roof height).
Turning circle approx. 11.9 m.
*Maximum headroom. **Elbow room width. ***Shoulder room width.













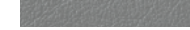

Dimensions in millimetres.
Dimensions are for vehicle at unladen weight.
Luggage compartment volume 535/1390 l (measured by the VDA method using 200 x 100 x 50 mm blocks; second value is with the rear seat backrest folded down and the vehicle loaded up to roof height).
Turning circle approx. 11.9 m.
*Maximum headroom. **Elbow room width. ***Shoulder room width.

| | Page | A7 Sportback | S7 Sportback |
|--|-----------|--------------|--------------|
| Equipment packages | 66 | | |
| S line exterior package | | ■ | — |
| S line sport package | | ■ | — |
| Solid paint finishes | 72 | | |
|  Ibis white | | □ | □ |
|  Brilliant black | | □ | □ |
| Metallic paint finishes | 72 | | |
|  Glacier white, metallic | | ■ | ■ |
|  Ice silver, metallic | | ■ | ■ |
|  Quartz grey, metallic | | ■ | ■ |
|  Dakota grey, metallic | | ■ | — |
|  Oolong grey, metallic | | ■ | ■ |
|  Moonlight blue, metallic | | ■ | ■ |
|  Havana black, metallic | | ■ | ■ |
| Pearl effect paint finishes | 73 | | |
|  Impala beige, pearl effect | | ■ | — |
|  Garnet red, pearl effect | | ■ | — |
|  Deep green, pearl effect | | ■ | — |
|  Phantom black, pearl effect | | ■ | ■ |
| Crystal effect paint finish | 73 | | |
|  Estoril blue, crystal effect | | — | ■ |
| Customised paint finishes | 73 | | |
|  Audi exclusive customised paint finishes. | | ■ | ■ |

| | Page | A7 Sportback | S7 Sportback |
|---|-----------|--------------|--------------|
| Wheels/tyres | 74 | | |
|  17" forged aluminium wheels in 6-arm design | | □ | — |
|  18" cast aluminium wheels in 7-arm dynamic design | | ■ | — |
|  19" cast aluminium wheels in 5-parallel-spoke design (S design) | | — | □ |
|  19" cast aluminium wheels in 5-arm Y design | | ■ | — |
|  19" cast aluminium wheels in 10-spoke design | | ■ | — |
|  19" Audi exclusive cast aluminium wheels in 5-twin-spoke design | | ■ | — |
|  20" forged aluminium wheels in 10-parallel-spoke design, anthracite, partly polished | | ■ | — |
|  20" cast aluminium wheels in 5-parallel-spoke star design (S design) | | — | ■ |













| | Page | A7 Sportback | S7 Sportback |
|--|------|--------------|--------------|
|  20" Audi exclusive cast aluminium wheels in 5-segment-spoke design | | ■ | ■ |
|  20" Audi exclusive forged aluminium wheels in 7-twin-spoke design, polished, 2-tone | | ■ | ■ |
|  20" Audi exclusive forged aluminium wheels in 7-twin-spoke design, high-gloss polished finish, single colour | | ■ | ■ |
|  21" Audi exclusive cast aluminium wheels in 5-arm rotor design | | ■ | ■ |
|  21" Audi exclusive cast aluminium wheels in 5-arm rotor design, matt titanium look, high-gloss turned finish | | ■ | ■ |
|  17" forged aluminium winter wheels in 6-arm design | | ■ | — |
|  19" cast aluminium winter wheels in 10-spoke design | | ■ | ■ |
|  20" cast aluminium winter wheels in 5-parallel-spoke star design (S design) | | — | ■ |

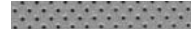





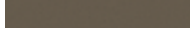

| | Page | A7 Sportback | S7 Sportback |
|--|-----------|--------------|--------------|
| Run-flat tyres | | ■ | — |
| Anti-theft wheel bolts | | ■ | ■ |
| Tyre repair kit | | □ | □ |
| Spare wheel, space-saving | | ■ | ■ |
| Tyre pressure loss indicator | | □ | □ |
| Vehicle tool kit | | □ | □ |
| Vehicle jack | | ■ | ■ |
| Seats | 76 | | |
| Standard seats, front | | □ | ■ |
| Comfort seats, front, with memory function | | ■ | ■ |
| Sport seats, front | | ■* | — |
| S sport seats, front | | ■* | □ |
| Seat upholstery for standard seats, front | 76 | | |
|  Horizon cloth, black | | □ | — |
|  Horizon cloth, titanium grey | | □ | — |
|  Horizon cloth, velvet beige | | □ | — |
|  Milano leather, black | | ■ | ■ |
|  Milano leather, titanium grey | | ■ | — |
|  Milano leather, velvet beige | | ■ | — |
|  Milano leather, nougat brown | | ■ | — |
|  Valcona leather, black | | ■ | — |
|  Valcona leather, titanium grey | | ■ | — |
|  Valcona leather, velvet beige | | ■ | — |
|  Valcona leather, nougat brown | | ■ | — |
|  Valcona leather, Goa beige | | ■ | ■ |
|  Audi exclusive leather upholstery and trim | | ■ | ■ |

□ Standard equipment ■ Optional equipment — not available

Country-specific variations possible. Please find out from your local Audi partner which equipment is standard and what optional equipment is available in your country.

*Only available in conjunction with S line sport package.

| | Page | A7 Sportback | S7 Sportback |
|---|-----------|--------------|--------------|
| Seat upholstery for comfort seats, front, with memory function | 78 | | |
|  Milano leather, black | | ■ | ■ |
|  Milano leather, titanium grey | | ■ | – |
|  Milano leather, velvet beige | | ■ | – |
|  Milano leather, nougat brown | | ■ | – |
|  Valcona leather, black | | ■ | ■ |
|  Valcona leather, titanium grey | | ■ | – |
|  Valcona leather, velvet beige | | ■ | – |
|  Valcona leather, Goa beige | | ■ | ■ |
|  Audi exclusive leather upholstery and trim | | ■ | ■ |
| Seat upholstery for S sport seats, front | 80 | | |
|  Alcantara/leather, black | | – | □ |
|  Alcantara/leather, lunar silver | | – | □ |
|  Valcona leather, black with contrasting stitching | | – | ■ |
|  Valcona leather, lunar silver with contrasting stitching | | – | ■ |
|  Audi exclusive leather upholstery and trim | | – | ■ |
| Cloth and leather upholstery and trim | 81 | | |
| Horizon upholstery and trim | | □ | – |
| Alcantara/leather combination | | – | □ |
| Milano leather upholstery and trim | | ■ | ■ |
| Valcona leather upholstery and trim | | ■ | ■ |
| Leather-covered armrests in the door trims | | ■ | ■ |
| Leather package | | ■ | – |
| Leather package including airbag cover | | ■ | ■ |
| Audi exclusive leather package including airbag cover | | ■ | ■ |
| Extended Audi exclusive leather package | | ■ | ■ |

| | Page | A7 Sportback | S7 Sportback |
|---|-----------|--------------|--------------|
| Audi exclusive leather upholstery and trim (package 1) | | ■ | ■ |
| Audi exclusive leather upholstery and trim (package 2) | | ■ | ■ |
| Audi exclusive piping for comfort seats | | ■ | ■ |
| Headlinings | 81 | | |
| Headlining in cloth | | □ | □ |
| Headlining in cloth, black | | ■ | ■ |
| Headlining in Alcantara black | | ■ | ■ |
| Headlining in Alcantara black with coloured Audi exclusive decorative stitching | | ■ | ■ |
| Inlays | 82 | | |
|  Micrometallic, platinum | | □ | – |
|  Reflex finish, moor brown | | □ | – |
|  Matt brushed aluminium | | ■ | □ |
|  Carbon Atlas | | – | ■ |
|  Piano finish, black | | ■ | ■ |
|  Fine grain ash, natural brown | | ■ | ■ |
|  Walnut, dark brown | | ■ | – |
|  Oak Beaufort | | ■ | ■ |
|  Aluminium/Beaufort, black | | ■ | ■ |
|  Audi exclusive inlays | | ■ | ■ |
| Lights | 84 | | |
| Xenon plus | | □ | □ |
| adaptive light including variable headlight range control | | ■ | ■ |
| LED headlights | | ■ | ■ |
| High-beam assist | | ■ | ■ |
| LED rear lights | | □ | □ |
| adaptive brake light | | □ | □ |

| | Page | A7 Sportback | S7 Sportback |
|--|-----------|--------------|--------------|
| Light/rain sensor | | □ | □ |
| Interior lighting | | □ | □ |
| Interior and exterior lighting package | | ■ | ■ |
| Ambient lighting | | ■ | ■ |
| Mirrors | 85 | | |
| Exterior mirrors with integrated LED indicator | | □ | □ |
| Exterior mirrors, electrically adjustable, heated and folding | | ■ | ■ |
| Exterior mirrors, electrically adjustable, heated and automatically dimming on both sides | | ■ | ■ |
| Exterior mirrors, electrically adjustable, heated and folding, automatically dimming on both sides | | ■ | ■ |
| Interior mirror, dimming | | □ | □ |
| Interior mirror, automatically dimming | | ■ | ■ |
| Roof system | 85 | | |
| Slide-and-tilt glass sunroof | | ■ | ■ |
| Closing systems | 86 | | |
| Radio controlled key | | □ | □ |
| Convenience key including sensor-controlled release of the luggage compartment lid | | ■ | ■ |
| Power-assisted closing for the doors | | ■ | ■ |
| Luggage compartment lid, electrically opening and closing | | □ | □ |
| Garage door opener (HomeLink) | | ■ | ■ |
| Engine start-stop button | | □ | □ |
| Anti-theft alarm | | ■ | □ |
| Preparation for tracking system | | ■ | ■ |
| Glazing | 86 | | |
| Dark-tinted windows (privacy glazing) | | ■ | ■ |
| Insulating/acoustic glass | | ■ | ■ |
| Insulating/acoustic glass and dark-tinted windows (privacy glazing) | | ■ | ■ |

| | Page | A7 Sportback | S7 Sportback |
|---|-----------|--------------|--------------|
| Heat-insulating glass | | □ | □ |
| Sun visors | | □ | □ |
| Sun screen | | ■ | ■ |
| Further exterior equipment | 87 | | |
| Provision for trailer towing hitch | | ■ | ■ |
| Trailer towing hitch | | ■ | ■ |
| High-gloss package | | □ | □ |
| Audi exclusive black high-gloss package | | ■ | ■ |
| Audi Singleframe | | □ | □ |
| Exhaust tailpipes | | □ | □ |
| Rear spoiler | | □ | □ |
| Model name/logo | | □ | □ |
| Seats/seating comfort | 87 | | |
| Front seats, electrically adjustable, including memory function for the driver seat | | ■ | □ |
| 4-way lumbar support for the front seats | | ■ | □ |
| Massage function, front | | ■ | ■ |
| Centre armrest, front | | □ | □ |
| Rear seat system | | □ | ■ |
| Rear seat system 2+1 | | ■ | – |
| S sport seats in the rear | | ■* | □ |
| ISOFIX child seat mounting for the outer rear seats | | □ | □ |
| ISOFIX child seat mounting for the front-passenger seat | | ■ | ■ |
| Seat heating, front and rear | | ■ | ■ |
| Seat heating, front | | ■ | ■ |
| Seat ventilation, front | | ■ | ■ |

□ Standard equipment ■ Optional equipment – not available

Country-specific variations possible. Please find out from your local Audi partner which equipment is standard and what optional equipment is available in your country.

*Only available in conjunction with S line sport package.

| | Page | A7 Sportback | S7 Sportback |
|---|--|-------------------------------------|--------------|
| Steering wheels/selector lever knobs/controls | 89 | | |
| Leather-covered multifunction steering wheel in 4-spoke design | <input type="checkbox"/> | – | |
| Leather-covered multifunction steering wheel in 4-spoke design with shift paddles | <input checked="" type="checkbox"/> ¹ | – | |
| Leather-covered multifunction steering wheel in 4-spoke design, heated | <input checked="" type="checkbox"/> | – | |
| Leather-covered multifunction sport steering wheel in 3-spoke design | <input checked="" type="checkbox"/> | – | |
| Leather-covered multifunction sport steering wheel in 3-spoke design with shift paddles | <input checked="" type="checkbox"/> | <input type="checkbox"/> | |
| Leather-covered multifunction sport steering wheel in 3-spoke design with shift paddles, heated | <input checked="" type="checkbox"/> | <input checked="" type="checkbox"/> | |
| Audi exclusive steering wheel rim with wooden segments | <input checked="" type="checkbox"/> | – | |
| Audi exclusive leather steering wheel rim | <input checked="" type="checkbox"/> | <input checked="" type="checkbox"/> | |
| Steering wheel rim with wooden segments | <input checked="" type="checkbox"/> | – | |
| Electric steering wheel adjustment | <input checked="" type="checkbox"/> | <input checked="" type="checkbox"/> | |
| Audi exclusive selector lever knob with wooden segment | <input checked="" type="checkbox"/> | – | |
| Selector lever knob with wooden segment | <input checked="" type="checkbox"/> | – | |
| Selector lever knob in leather | <input type="checkbox"/> | – | |
| Selector lever knob in aluminium look | – | <input type="checkbox"/> | |
| Audi exclusive leather controls | <input checked="" type="checkbox"/> | <input checked="" type="checkbox"/> | |
| Climate control | 90 | | |
| Auxiliary heating/ventilation | <input checked="" type="checkbox"/> | <input checked="" type="checkbox"/> | |
| Deluxe automatic air conditioning | <input type="checkbox"/> | – | |
| 4-zone deluxe automatic air conditioning | <input checked="" type="checkbox"/> | <input type="checkbox"/> | |
| Luggage securing and storage systems | 90 | | |
| Storage compartments | <input type="checkbox"/> | <input type="checkbox"/> | |
| Glove compartment | <input type="checkbox"/> | <input type="checkbox"/> | |
| Storage package | <input checked="" type="checkbox"/> | <input type="checkbox"/> | |

| | Page | A7 Sportback | S7 Sportback |
|---|-------------------------------------|-------------------------------------|--------------|
| Cup holders | <input type="checkbox"/> | <input type="checkbox"/> | |
| Bag hooks | <input type="checkbox"/> | <input type="checkbox"/> | |
| Reversible mat | <input checked="" type="checkbox"/> | <input checked="" type="checkbox"/> | |
| Through-loading facility | – | <input type="checkbox"/> | |
| Through-loading facility with removable ski/snowboard bag | <input checked="" type="checkbox"/> | <input checked="" type="checkbox"/> | |
| Luggage compartment | <input type="checkbox"/> | <input type="checkbox"/> | |
| Further interior equipment | 91 | | |
| Floor mats, front | <input type="checkbox"/> | – | |
| Floor mats, front and rear | <input checked="" type="checkbox"/> | <input type="checkbox"/> | |
| Audi exclusive floor mats | <input checked="" type="checkbox"/> | <input checked="" type="checkbox"/> | |
| Audi exclusive carpet and floor mats | <input checked="" type="checkbox"/> | <input checked="" type="checkbox"/> | |
| Pedals and footrest in aluminium look | – | <input type="checkbox"/> | |
| Door sill trims with aluminium inlays | <input type="checkbox"/> | <input type="checkbox"/> | |
| Aluminium look in the interior | <input type="checkbox"/> | <input type="checkbox"/> | |
| Cigarette lighter and ashtray | <input checked="" type="checkbox"/> | <input checked="" type="checkbox"/> | |
| Non-smoker version | <input type="checkbox"/> | <input type="checkbox"/> | |
| MMI® and navigation systems | 91 | | |
| MMI® radio | <input type="checkbox"/> | – | |
| MMI® radio plus | <input checked="" type="checkbox"/> | <input type="checkbox"/> | |
| MMI® navigation | <input checked="" type="checkbox"/> | <input checked="" type="checkbox"/> | |
| MMI® navigation plus with MMI touch | <input checked="" type="checkbox"/> | <input checked="" type="checkbox"/> | |
| MMI® touch | <input checked="" type="checkbox"/> | <input checked="" type="checkbox"/> | |
| Vehicle support based on navigation data | <input checked="" type="checkbox"/> | <input checked="" type="checkbox"/> | |
| Centre display | <input type="checkbox"/> | – | |

| | Page | A7 Sportback | S7 Sportback |
|--|-------------------------------------|-------------------------------------|--------------|
| Driver information system | <input checked="" type="checkbox"/> | – | |
| Driver information system with 7-inch colour display | <input checked="" type="checkbox"/> | <input type="checkbox"/> | |
| Attention assist | <input checked="" type="checkbox"/> | <input type="checkbox"/> | |
| Radio and TV systems | 93 | | |
| Digital Audio Broadcasting | <input checked="" type="checkbox"/> | <input checked="" type="checkbox"/> | |
| Digital TV reception | <input checked="" type="checkbox"/> | <input checked="" type="checkbox"/> | |
| Preparation for Rear Seat Entertainment | <input checked="" type="checkbox"/> | <input checked="" type="checkbox"/> | |
| Bang & Olufsen Advanced Sound System | <input checked="" type="checkbox"/> | <input checked="" type="checkbox"/> | |
| Audi sound system | <input checked="" type="checkbox"/> | <input type="checkbox"/> | |
| BOSE Surround Sound | <input checked="" type="checkbox"/> | <input checked="" type="checkbox"/> | |
| CD changer | <input checked="" type="checkbox"/> | <input checked="" type="checkbox"/> | |
| DVD/CD changer | <input checked="" type="checkbox"/> | <input checked="" type="checkbox"/> | |
| Audi music interface | <input checked="" type="checkbox"/> | <input checked="" type="checkbox"/> | |
| Adapter cable set for Audi music interface | <input checked="" type="checkbox"/> | <input checked="" type="checkbox"/> | |
| Adapter cable set plus for Audi music interface | <input checked="" type="checkbox"/> | <input checked="" type="checkbox"/> | |
| Telephone and communication | 94 | | |
| Audi connect including car phone | <input checked="" type="checkbox"/> | <input checked="" type="checkbox"/> | |
| Handset in the front for car phone | <input checked="" type="checkbox"/> | <input checked="" type="checkbox"/> | |
| Preparation for mobile phone (Bluetooth) | <input checked="" type="checkbox"/> | <input checked="" type="checkbox"/> | |
| Bluetooth interface | <input checked="" type="checkbox"/> | <input type="checkbox"/> | |
| Assistance systems | 95 | | |
| Audi pre sense basic | <input checked="" type="checkbox"/> | <input checked="" type="checkbox"/> | |
| adaptive cruise control with Stop&Go function incl. Audi pre sense front | <input checked="" type="checkbox"/> | <input checked="" type="checkbox"/> | |
| Cruise control | <input checked="" type="checkbox"/> | <input checked="" type="checkbox"/> | |
| Audi side assist including Audi pre sense rear | <input checked="" type="checkbox"/> | <input checked="" type="checkbox"/> | |

| | Page | A7 Sportback | S7 Sportback |
|--|--|-------------------------------------|--------------|
| Audi active lane assist | <input checked="" type="checkbox"/> | <input checked="" type="checkbox"/> | |
| Assistance package including Audi pre sense plus | <input checked="" type="checkbox"/> | <input checked="" type="checkbox"/> | |
| Hold assist | <input type="checkbox"/> | <input type="checkbox"/> | |
| Night vision assistant with highlighting of detected pedestrians | <input checked="" type="checkbox"/> | <input checked="" type="checkbox"/> | |
| Head-up display | <input checked="" type="checkbox"/> | <input checked="" type="checkbox"/> | |
| Camera-based speed limit display | <input checked="" type="checkbox"/> | <input checked="" type="checkbox"/> | |
| Parking system plus | <input checked="" type="checkbox"/> | <input checked="" type="checkbox"/> | |
| Park assist with display of surroundings | <input checked="" type="checkbox"/> | <input checked="" type="checkbox"/> | |
| Reversing camera | <input checked="" type="checkbox"/> | <input checked="" type="checkbox"/> | |
| Front and reversing cameras | <input checked="" type="checkbox"/> | <input checked="" type="checkbox"/> | |
| Suspensions/brakes | 97 | | |
| Audi drive select | <input type="checkbox"/> | <input type="checkbox"/> | |
| adaptive air suspension | <input checked="" type="checkbox"/> | – | |
| adaptive air suspension sport | – | <input type="checkbox"/> | |
| Sport suspension | <input checked="" type="checkbox"/> | – | |
| S line sport suspension | <input checked="" type="checkbox"/> | – | |
| Brake system | <input type="checkbox"/> | <input type="checkbox"/> | |
| Electromechanical parking brake | <input type="checkbox"/> | <input type="checkbox"/> | |
| Ceramic brake | <input checked="" type="checkbox"/> ² | <input checked="" type="checkbox"/> | |
| Technology/safety | 97 | | |
| Body, galvanised | <input type="checkbox"/> | <input type="checkbox"/> | |
| Side impact protection | <input type="checkbox"/> | <input type="checkbox"/> | |
| Child-proof lock | <input type="checkbox"/> | <input type="checkbox"/> | |
| Airbags | <input type="checkbox"/> | <input type="checkbox"/> | |
| Side airbags at the front and head airbag system | <input type="checkbox"/> | <input type="checkbox"/> | |

Standard equipment Optional equipment Standard/Optional equipment varies by model – not available

Country-specific variations possible. Please find out from your local Audi partner which equipment is standard and what optional equipment is available in your country.

¹Standard for 3.0 TDI quattro (230 kW). ²Only for A7 3.0 TFSI quattro (228 kW) and A7 3.0 TDI quattro (230 kW).

| | Page | A7 Sportback | S7 Sportback |
|---|-----------|----------------|--------------|
| Technology/safety (continuation) | 97 | | |
| Side airbags, rear | | ■ | ■ |
| Integrated head restraint system | | □ | □ |
| Instrument cluster | | □ | □ |
| Safety steering column | | □ | □ |
| Seat belts | | □ | □ |
| Audi exclusive seat belts | | ■ | ■ |
| 65 l fuel tank | | □ | – |
| 73 l fuel tank | | □ ¹ | – |
| 75 l fuel tank | | ■ | □ |
| Warning triangle | | ■ | ■ |
| First-aid kit | | ■ | ■ |
| Antilock Brake System (ABS) | | □ | □ |
| Anti-Slip Regulation (ASR) | | □ | □ |
| Electronic Differential Lock (EDL) | | □ | □ |
| Electronic Stabilisation Control (ESC) | | □ | □ |
| Electronic Stabilisation Control (ESC) with electronic axle-differential lock | | □ ² | – |
| Electromechanical power steering | | □ | □ |
| Dynamic steering | | ■ | ■ |
| multitronic® | | □ ² | – |
| S tronic® | | □ ³ | □ |
| tiptronic | | □ ³ | – |
| quattro® | | □ ³ | □ |
| quattro® with sport differential | | ■ | ■ |
| Recuperation | | □ | □ |

□ Standard equipment ■ Optional equipment – not available

Country-specific variations possible. Please find out from your local Audi partner which equipment is standard and what optional equipment is available in your country.

| | Page | A7 Sportback | S7 Sportback |
|-------------------------------|-----------|----------------|--------------|
| Start-stop system | | □ | □ |
| Audi TDI clean diesel | | □ ¹ | – |
| Active Noise Cancellation | | – | □ |
| Audi Extended Warranty | 99 | | |
| Audi Extended Warranty | | ■ | ■ |

Equipment for the Audi A7 Sportback illustrated (p. 5–23):

Paint finish: ice silver, metallic; wheels: forged aluminium wheels in 10-parallel-spoke design, anthracite, partly polished; seats/seat upholstery: standard seats, front, in Valcona leather, black; inlays: walnut, dark brown

Equipment for the Audi S7 Sportback illustrated (p. 24–37):

Paint finish: glacier white, metallic; wheels: cast aluminium wheels in 5-parallel-spoke star design; Seats/seat upholstery: S sport seats, front, in Valcona leather, black, with contrasting stitching; inlays: carbon Atlas

¹ Only for A7 3.0 TDI clean diesel quattro (180 kW). ² Only for A7 2.8 FSI (150 kW) and A7 3.0 TDI (150 kW). ³ Information on the availability of your preferred engine variant can be found in the technical data.



Responsibility

Living up to our responsibilities is a principle that is firmly anchored in Audi strategy. Alongside commercial success and international competitiveness, our responsibility toward company employees and society as a whole is a key consideration, as is protecting the environment and conserving resources. And what is true in the details – our catalogues are printed on FSC-certified paper – also holds in general: Audi develops cars that are not only sporty and emotive but also ever more efficient. In the long run, Audi wants its products to allow CO₂-neutral

mobility. Seeing to it that production in Audi plants gradually becomes CO₂-neutral is another aspect of our comprehensive approach. Audi is also committed to society – particularly in the fields of education, technology and social projects. At Audi, sustainability is closely linked with how we see the future: the Audi Urban Future Initiative sees Audi working with international experts to get to the root of future urban challenges and trends in mobility.

Discover the world of Audi.



Choosing an Audi means choosing a brand that offers more. More individuality. More exclusivity. More fascination.



The Audi experience

The fascination of Audi can be experienced in many different ways. Audi City in London, for example, gives you digital access to all models at their actual size and in real time. And of course it is always worth visiting one of the major motor shows. This is where Audi always presents its new models and invites you to take a look at how the future is being shaped with "Vorsprung durch Technik". Anyone interested in seeing how Audi is already putting this into practice will find fascinating insight in the "Vorsprung durch Technik" online special at www.audi.com.

But a look back can also be rewarding: at the Audi museum mobile in Ingolstadt, history and high-tech go hand in hand. A total of 130 historic exhibits and state-of-the-art forms of presentation make for a thrilling symbiosis. Plus, Audi driving experience allows you to live the excitement and countless possibilities of current Audi models. Here, pure driving enjoyment is combined with valuable learning effects. This is ensured by a team of specially trained and highly qualified instructors who provide practical tips to help you optimise your driving skills.



Team spirit

Motorsport is a driving force behind the brand. For years Audi has been among the champions in various racing series, for instance the 24 Hours of Le Mans or the DTM German Touring Car Masters. The values that are crucial in many different areas of sport are also central ones for Audi: precision, passion and technology. No coincidence then that Audi has been sponsoring sporting events for

many years. In the world of winter sports, for example, Audi has been the main sponsor of the German Ski Association (DSV) for almost three decades and has also partnered 14 other national alpine teams. In football, we support national and international teams. And Audi is also a partner for the German Olympic Sports Confederation.

www.audi.com

Information on all the topics mentioned above can be found on our website: www.audi.com.

 www.audi.com

 configurator.audi.com

 www.audi.com/vorsprung-durch-technik

 www.audi.com/driving

 www.audi.com/cr



AUDI AG
85045 Ingolstadt
www.audi.com
Valid from April 2013

Printed in Germany
333/1130.72.18

The models and equipment versions illustrated and described in this brochure and some of the services listed are not available in all countries. Some of the cars illustrated are equipped with optional equipment for which an extra charge is made. Details concerning the delivery specifications, appearance, performance, dimensions and weights, fuel consumption and running costs of the vehicle were correct to the best of our knowledge at the time of going to press. Deviations from the colours and shapes shown in the illustrations may occur. No liability is accepted for errors and printing errors. Not to be reproduced, including in part, without the written approval of AUDI AG.

This brochure is printed on paper made from pulp bleached without the use of chlorine.

