



ASTON MARTIN

DB9



THE ASTON MARTIN DB9 IS THE
QUINTESSENTIAL SPORTING GRAND TOURER.
A TRUE THOROUGHbred, THE DB9 IS THAT
RAREST OF THINGS, A PERFORMANCE CAR THAT
COMBINES TRUE BEAUTY WITH FUNCTIONALITY.
ABOVE ALL, THE DB9 ENCAPSULATES THE
QUALITIES EMBODIED IN EVERY ASTON MARTIN:
POWER, BEAUTY AND SOUL.

Power Beauty Soul

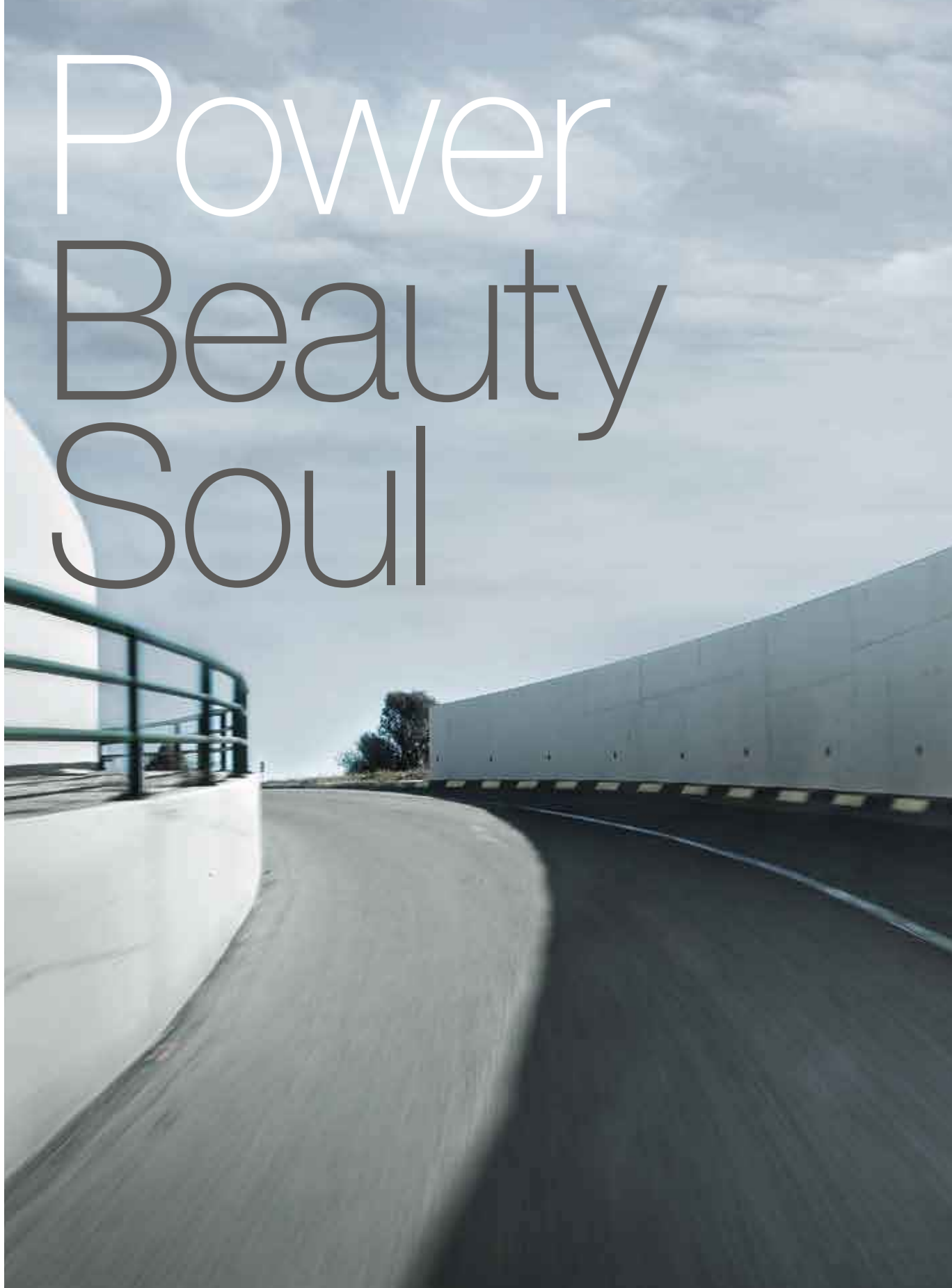

The DB9 is exceptionally powerful, a high-performance sports car with supreme balance, handling and ride. Powered by a 350 kW (470 bhp) 6.0-litre V12 engine, the DB9 combines effortless touring ability with sports car precision and agility.

Power is nothing without control, and the DB9 is engineered for poise and predictability at all times. Meticulously designed steering, suspension and brakes deliver vital feedback, placing the driver at the heart of the machine. A choice of 'Touchtronic 2' automatic transmission, with steering wheel-mounted paddles, or six-speed manual completes the relationship between driver, car and road.



Power Beauty Soul

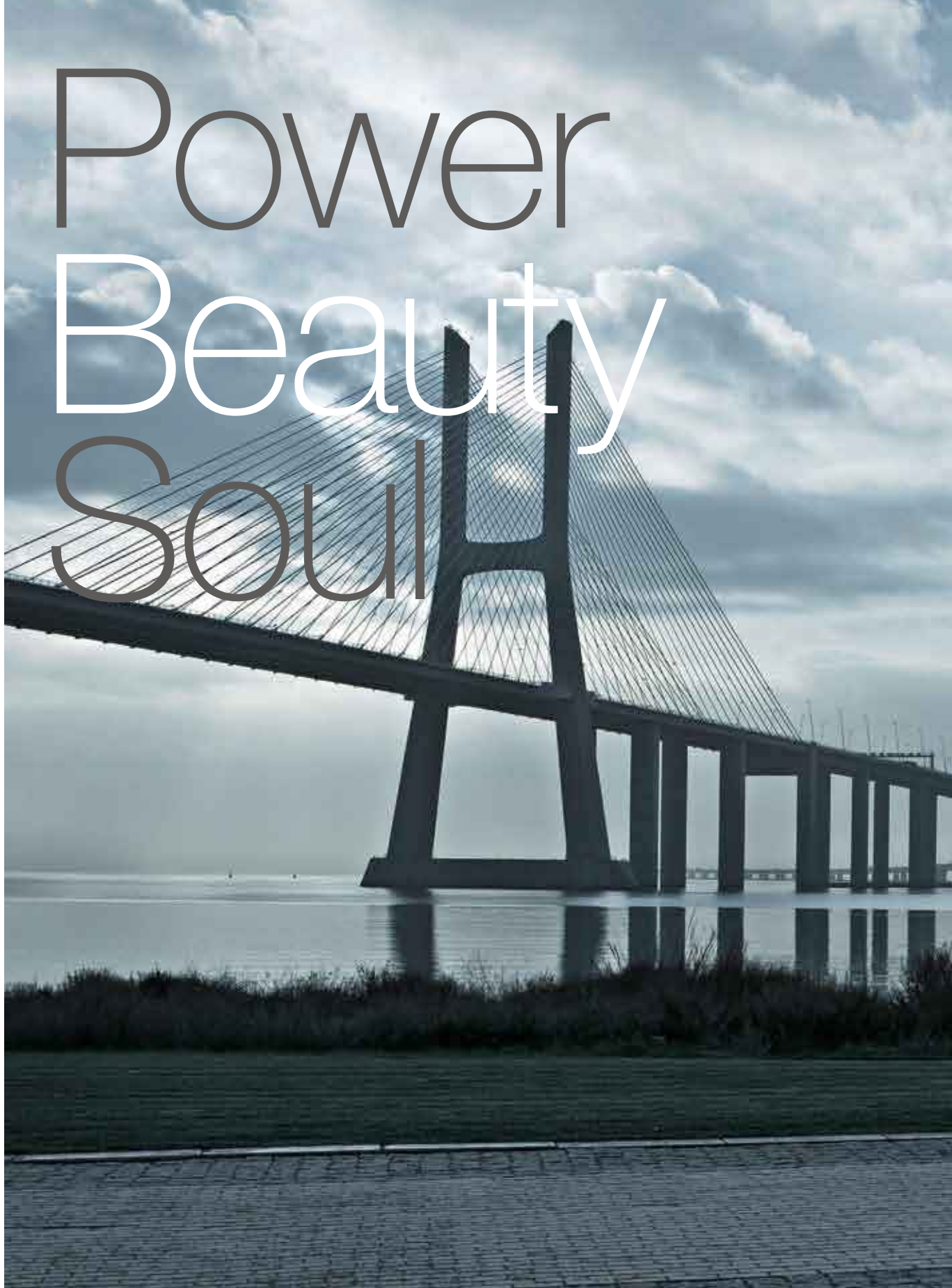

The DB9 is the epitome of dynamic beauty. Technical perfection is swathed in elegant bodywork, with lines that are fluid and modern yet classic and, above all, typically Aston Martin.

From the front grille through to the curvaceous rear haunches, the DB9 is a contemporary design icon. Every surface and component is carefully detailed, using ultra-modern materials and a combination of high technology manufacturing and traditional craft skills. Right down to the hand-enamelled Aston Martin badge, true craftsmanship is always in evidence.

DB9 Coupe shown with optional 19" 5-spoke, diamond turned, forged alloy road wheels.



Power Beauty Soul

The DB9 Volante adds another dimension: the open air. The Volante's sleek lines are made possible by sophisticated design and engineering, resulting in an open-topped car with a clean, flowing profile. Swift and invigorating to drive, the Volante is effortless and seductive.

The DB9 is entirely in its element on the open road, providing an inspirational experience for both driver and passenger alike. Beauty, elegance, craftsmanship and the roar of its V12 engine are brought together in one emotional package, an object of beauty that never fails to stir the soul.



Every detail of the DB9 is carefully composed, inside and out. The unique 'swan-wing' doors are designed to open outwards yet upwards, easing access and avoiding high kerbs. The iconic Aston Martin grille, its distinctive five bars created from anodised aluminium, forms a subtle yet aggressive visual statement.



The DB9 Coupe and Volante were designed in tandem, ensuring that the mechanical expertise that underpins each car was never compromised. Distinctive yet also subtle, the curve of the Coupe's roofline finds an echo in the swept-back rear deck of the Volante, form and function in perfect harmony.

DB9 Coupe shown with optional 19" 5-spoke, diamond turned, forged alloy road wheels.

Both Coupe and Volante are designed for sophisticated and predictable high-speed handling, as well as everyday refinement and usability.

A new adaptive damping system (ADS) is provided as standard equipment on both Coupe and Volante models. The cars dampers are specifically tuned to the driving characteristics of the DB9 and 'adapt' automatically whether in Normal - comfort mode or Sport - dynamic mode. The system automatically adjusts to the appropriate setting according to information received from sensors monitoring throttle, brakes and steering.



Even when standing still, the DB9 conveys poise and grace, power and strength. The design is meticulous: every surface carefully honed and shaped to create a precise balance between curve and crease, volume and space. Light falling on the car generates fluid, unbroken lines that flow across the curves, highlighting the intersection of line and shape.



From the rear, the DB9's sense of power, purpose and strength is emphasised by muscular rear haunches, distinctive tail and wheel arches filled with lightweight aluminium alloy wheels. Nothing is overlooked, from the junction between the roof and rear flanks to the light line that runs through the doors to unite with the iconic Aston Martin side strake.

DB9 Coupe shown with optional 19" 10-spoke, diamond turned, forged alloy road wheels with Graphite finish.













The DB9 creates a classic automotive soundtrack. With an exhaust note that is sonorous and evocative, the hand-built V12 provides a glorious aural accompaniment to the view from behind the wheel.



DB9 Coupe shown with optional 19" 5-spoke, diamond turned, forged alloy road wheels.



On the road, the DB9 is fluent and composed, capable of delivering both refined long-distance touring and a thrillingly dynamic drive. The DB9 is the definitive sporting grand tourer; no other car in its class provides driver and passenger with such an exquisite experience.





Aston Martin has always stood for exceptional levels of craftsmanship and, true to form, the DB9's cabin is a feast for the senses. The sublime combination of hand-crafted materials, from the delicate stitching on the leather sports seats to the choice of luxurious interior woods, results in an incomparable ambience.



The DB9's interior synthesises craftsmanship with high technology; dedicated to long-distance, high-performance driving, it offers comfort, convenience and practicality. The interior invites close inspection, from the tactile delight of the start sequence using the glass and stainless steel Emotion Control Unit (ECU) to the detailed, watch-like dials of the instrument panel and the comprehensive standard equipment.

Under the skin, the DB9 uses Aston Martin's high technology VH (Vertical Horizontal) structure, a unique aluminium platform that gives the car huge strength and solidity. These underpinnings shape the DB9's character: a sporting GT with an elegant silhouette that is instantly recognisable as an Aston Martin.

DB9 Coupe shown with optional 19" 5-spoke, diamond turned, forged alloy road wheels.









The Volante experience is not just about driving, handling and performance. Sophisticated packaging ensures breathtaking simplicity and elegance of form.

The hood combines outstanding craftsmanship with skilled engineering, ensuring every last detail, inside and out, works swiftly and efficiently. Functionalism has never looked so good.



Like the Coupe, the Volante's performance is supported by Aston Martin's excellent safety systems. Dynamic Stability Control (DSC) ensures power is delivered smoothly and efficiently, while enhanced braking aids provide exceptional stopping ability, regardless of the conditions.

The rigid VH structure, in conjunction with an advanced safety system that includes deployable roll-over bars on the Volante, provides a high level of occupant protection.

DB9 Volante shown with optional 19" 10-spoke, diamond turned, forged alloy road wheels with Graphite finish.















A high-angle, close-up photograph of the interior of an Aston Martin DB9 Volante. The image shows the front passenger seat and the center console, both upholstered in rich, brown leather with visible stitching. The dashboard and door panels feature dark wood veneer and silver metal trim. The car's top is down, and the background is a bright, overcast sky.

An Aston Martin is about style and elegance, and nowhere is this more evident than in the DB9's cabin, with its supportive seats, deep centre console and rich palette of luxurious finishes, including supple, hand-stitched leather and a choice of Walnut, Mahogany, Bamboo, Tamo Ash or Piano Black wood veneers, and two choices of metal fascia trim.

This fusion of high technology and skilful craft is opened to the world once the Volante's hood is stowed quietly and quickly beneath its metal tonneau cover.

DB9 Volante shown with optional Bang & Olufsen Beosound Audio System and Nexus Alloy fascia trim.





All controls are within easy reach. The highly intuitive 'Touchtronic 2' transmission is operated via simple, dashboard-mounted buttons, flanking the docking station for the ECU. A combination of solid aluminium dials and chromed buttons operate the DB9's audio systems, Bluetooth telephony and hard-disk based navigation, while a classic analogue clock is placed at the heart of the console.

DB9 Volante shown with optional Bang & Olufsen Beosound Audio System and Nexus Alloy facia trim.





Raise the centre armrest and you'll find a space to store your iPod, iPhone or any telephone or MP3 device. All MP3 player functions are duplicated on the DB9's dashboard screen, alongside mobile phone functions. A six-CD autochanger is included as standard; all audio is processed by Aston Martin's rich-sounding 700 W Premium Audio System, tailored for the DB9.

DB9 Volante shown with optional Bang & Olufsen Beosound Audio System and Nexus Alloy fascia trim.





ASTON MARTIN DB9

The Aston Martin DB9 is a thoroughbred sports car with GT levels of comfort and refinement. Combining Aston Martin's unique character with an uncompromising design philosophy, the DB9 was borne out of a synthesis of traditional craftsmanship, high-tech manufacturing, modern components and use of the finest materials. The DB9 is both a full-blooded sports car and a hugely capable grand tourer. Whether in Coupe or Volante form, it offers a supreme combination of driver involvement, character, luxury and refinement. Beautifully styled, the DB9 never fails to stir the soul with its unique sound, power and performance.

This purebred sports car is also a technical triumph, its beauty signifying aerodynamic efficiency, its power unencumbered by weight, its devastating straight-line performance paired with exquisite handling. All great sports cars strive to balance these qualities, and the DB9 creates an experience that is both unique and unforgettable. What the driver sees, hears and feels is in harmony. The reward is total involvement: a level of engagement that truly stimulates the senses, that re-ignites a passion for driving. But an Aston Martin is also about luxury, indulgence and enjoyment – it is a feast for the senses. Sure enough, the magnificent exterior styling of the DB9 gives way to a sumptuous, comprehensively equipped cabin, trimmed in the finest materials. Every element is perfectly conceived, from the 6.0-litre V12 engine to the hand-stitched seats and carefully selected interior finishes. Nothing is out of place.



ASTON MARTIN
HANDMADE
IN ENGLAND
PERFORMANCE
PRELUDE

PERFORMANCE

A great sports car needs a great engine – it is the heart of any high-performance machine. In the DB9's case, that great engine is a powerful yet refined aluminium 6.0-litre V12. It produces 350 kW (470 bhp) and 600 Nm (443 lb ft) of torque. That gives a power to weight ratio of 199 kW/tonne (267 bhp/tonne) – one of the highest figures in its class.

Performance is enormous, yet usable. Top speed is up to 306 km/h (190 mph) and acceleration sees 0-62 mph in 4.8 seconds for both the automatic and the six-speed manual.

Despite these immensely impressive figures and the instant nature of the throttle response, the DB9 can also relax. Eighty per cent of the V12 engine's torque, or pulling power, is available from as little as 1500 rpm, while enormous mid-range performance provides instant overtaking power almost regardless of engine speed, or even which gear the car is in.

Aston Martins have always sounded like true thoroughbreds and the DB9 is no exception: the 6.0-litre V12 has been described as one of the finest-sounding engines in production. The exhaust is tuned not only to be efficient but also to provide the appropriate musical accompaniment. Under hard acceleration, the V12 has an exhilarating roar; when cruising, the growl becomes muted and melodic, hinting at the power within without being brash and obtrusive. The DB9 offers a choice of two rear mid-mounted transmissions, both allowing the driver superb interaction with the car.

The six-speed 'Touchtronic 2' fully automatic transmission uses shift-by-wire technology and replaces the conventional gear lever with dashboard-mounted buttons to select Park, Reverse, Neutral and Drive modes. The result is sophisticated yet intuitive: quick and easy to use and providing instant response to driver input.

If preferred, or where driving conditions allow, magnesium alloy paddles sited behind the steering wheel enable instant, F1-style gear changes, providing the choice of rapid and involving fingertip gear changing.

Unlike many other sports GTs, the DB9 also offers a six-speed manual transmission, featuring a conventional gear change and high-capacity, twin-plate clutch.

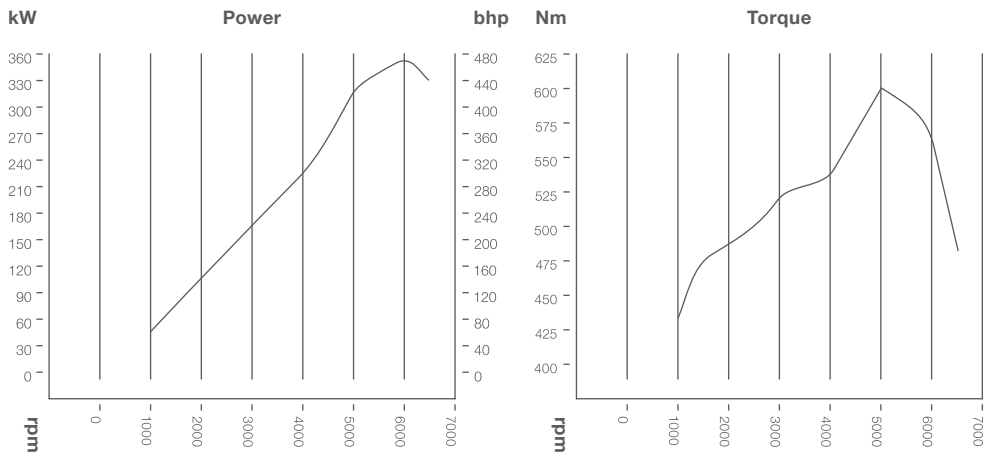



DESIGN

No sports car manufacturer has a greater design heritage than Aston Martin. Responsible for some of the most beautiful sports cars ever made, Aston Martin imbues every model with understated elegance and graceful styling, achieved through harmonious proportions, taut surfacing, a ground-hugging stance and thorough attention to detail.

An Aston Martin is subtle, not attention-seeking. The Coupe's side profile is clean and distinctive, with a single-sweep roofline that flows through to a distinctive tail. Key Aston Martin design elements include the distinctive grille, metal side strakes, signature rear window shape and wide, curvaceous haunches.

Good design, however, is not just about form; it is also about function.

An Aston Martin is by definition very fast, so it needs to be aerodynamically efficient. It must be superbly stable at high speed – even the exhaust silencer is aerodynamically shaped to help achieve this. The result is that the DB9 drives arrow-straight at high speed yet, like all great Aston Martins, it does so with supreme elegance and grace. The DB9 was designed from the outset as both a coupe and a convertible, an uncompromising approach that epitomises the engineering philosophy behind the car. The DB9 Volante is therefore one of the most structurally rigid and best-handling convertibles in the world. It is also one of the fastest and quietest.

As with all Aston Martins, beauty and balance are critical. The DB9 Volante is perfectly proportioned from every angle, roof up or down. The convertible top retracts at the single push of a button and swiftly stows beneath a hard tonneau cover that closes flush with the rear bodywork, leaving the lines of the car flowing and unbroken.

The Volante's elegant folding fabric roof is light and durable. A layer of Thinsulate® material insulates the cabin from both noise and the elements when the roof is up, and optimises headroom for the driver and front passenger. There is also no loss of practicality – the folding fabric roof is compact when stowed, allowing the DB9 Volante to retain its rear seats and ample boot space.

Safety is always of paramount importance to Aston Martin. The DB9 Volante rises to the challenge of being a convertible car by having amongst other things special tilt sensors which are designed to detect the possibility of a roll-over and deploy two strengthened hoops from the rear seat headrests. Further protection is offered by the windscreen A-pillars, which have been rig tested to withstand more than twice the total weight of the car.

Great sports cars must handle superbly. They should respond quickly and predictably to driver commands; they should be nimble and agile. To achieve the low weight that is the starting point for such agility, all the DB9's major body and mechanical components are made from either aluminium, magnesium alloy or advanced, lightweight, composite materials.

The front-to-rear weight distribution of the DB9 is a perfect 50:50, with 85 per cent of the car's mass sited between the front and rear axles. The aluminium V12 engine is mounted as far back as possible in a 'front mid-engined' layout. The compact aluminium transaxle housing the gearbox and final drive is positioned at the rear, forward of the rear axle.

A lightweight and rigid carbon-fibre propeller shaft, housed within a cast aluminium torque tube, transfers torque from the front mid-mounted engine to the rear mid-mounted transmission, helping to give the DB9 its superb poise, balance and stability. The result is a car that can be driven with great ease and precision, thanks to the flow of communication through the steering.

The DB9 excels not because it has myriad electronic controls added in an attempt to overcome compromise, but because it has an inherently light and rigid structure, perfect weight distribution and finely tuned suspension.

More than any other quality, the DB9 seeks to serve up the richest driving experience in the sports GT class. It serenades the driver with its balance of engine and exhaust notes, provides scintillating performance and agility and has a seductive blend of fluent steering and linear controls. This combination of performance and luxury makes the DB9 both an exceptional out-and-out sports car and an ultra-refined GT.

The DB9 cabin is focused on the driver, who sits as low and as close as possible to the car's centre of gravity. Combined with the rigid body structure and all-aluminium, double-wishbone suspension, the result is unfiltered feedback of the car's dynamic behaviour. This unparalleled two-way communication – car to driver, driver to car – is at the very core of the DB9's design philosophy.

The steering, power-assisted for lightness, is superbly responsive, helped by the car's low weight and excellent balance. The large disc brakes – 355 mm diameter discs at the front and 330 mm at the rear – are ventilated and grooved, to aid cooling and boost braking performance. Radially mounted, four-piston, monobloc calipers provide great stopping power with a firm yet progressive pedal feel.

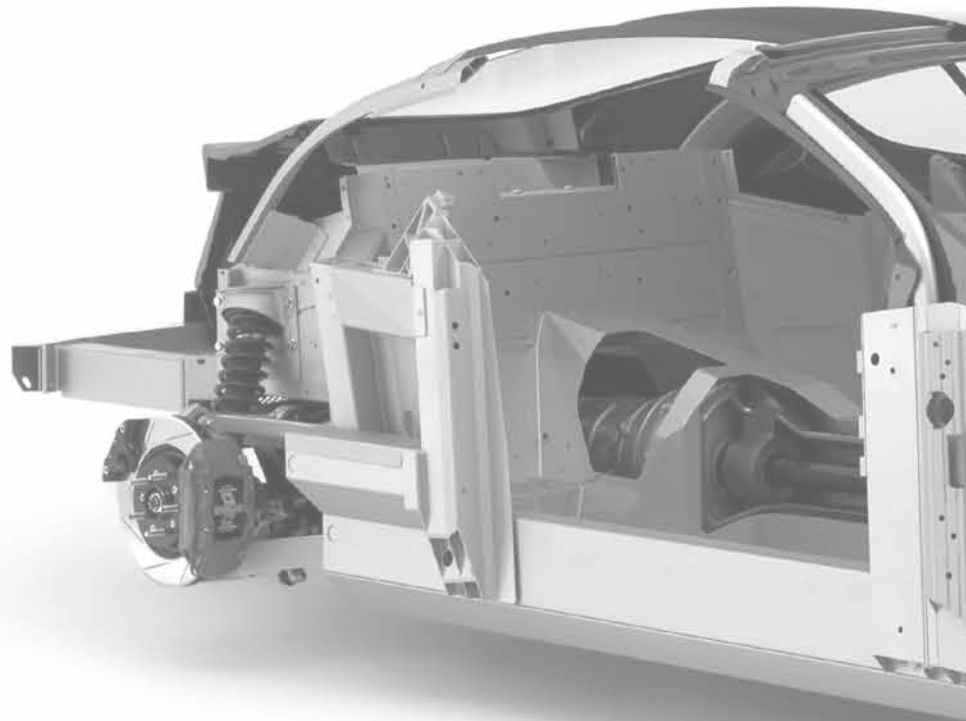

Our approach to active safety in the DB9 begins with its inherent agility and responsiveness. The lightweight, rigid body structure and superbly tuned suspension and steering are further aided by a host of advanced electronics. These include Dynamic Stability Control (DSC) and the latest-generation ABS brakes which, if the system detects loss of grip, combine to help keep the car stable and balanced.

The Bilstein continuously adaptive damping system, first introduced on the DBS, is provided as standard equipment. The dampers are specifically tuned to the driving characteristics of the DB9 and offer a 'Normal' mode, in which they adapt to deliver greater ride comfort, and a 'Sport' mode for better handling and control during dynamic driving. In each mode, five different sets of ride and handling characteristics are available to maintain precise control at all times. The system automatically adjusts to the appropriate setting according to information from sensors monitoring throttle, brake, steering rack and vehicle speed.

Electronic Brakeforce Distribution (EBD) and Emergency Brake Assist (EBA) are also employed. EBD balances the front-to-rear braking bias, to give optimal braking performance. In an emergency, EBA sensors detect when maximum braking is required and automatically apply the appropriate force.

The DB9 offers class-leading approaches to safety. It has a rigid aluminium structure designed to provide a supremely robust passenger cell, occupants are further protected by extruded aluminium crumple zones at the front and rear of the car. Crash and safety testing for the DB9 was conducted at the world-renowned Volvo Safety Centre in Sweden.

Dual-stage driver and passenger airbags, seat-mounted side airbags and seat-belt pretensioners offer additional protection. In the Volante, roll-over hoops are designed to automatically and instantly deploy from the headrests in the event of an accident. The DB9 is equipped with an integrated Passive Anti Theft System (PATS), which uses a rolling code electronic ignition key to prevent unauthorised engine start-up. It also includes the very latest in vehicle alarm systems, featuring parametric sensors and double locking for doors.

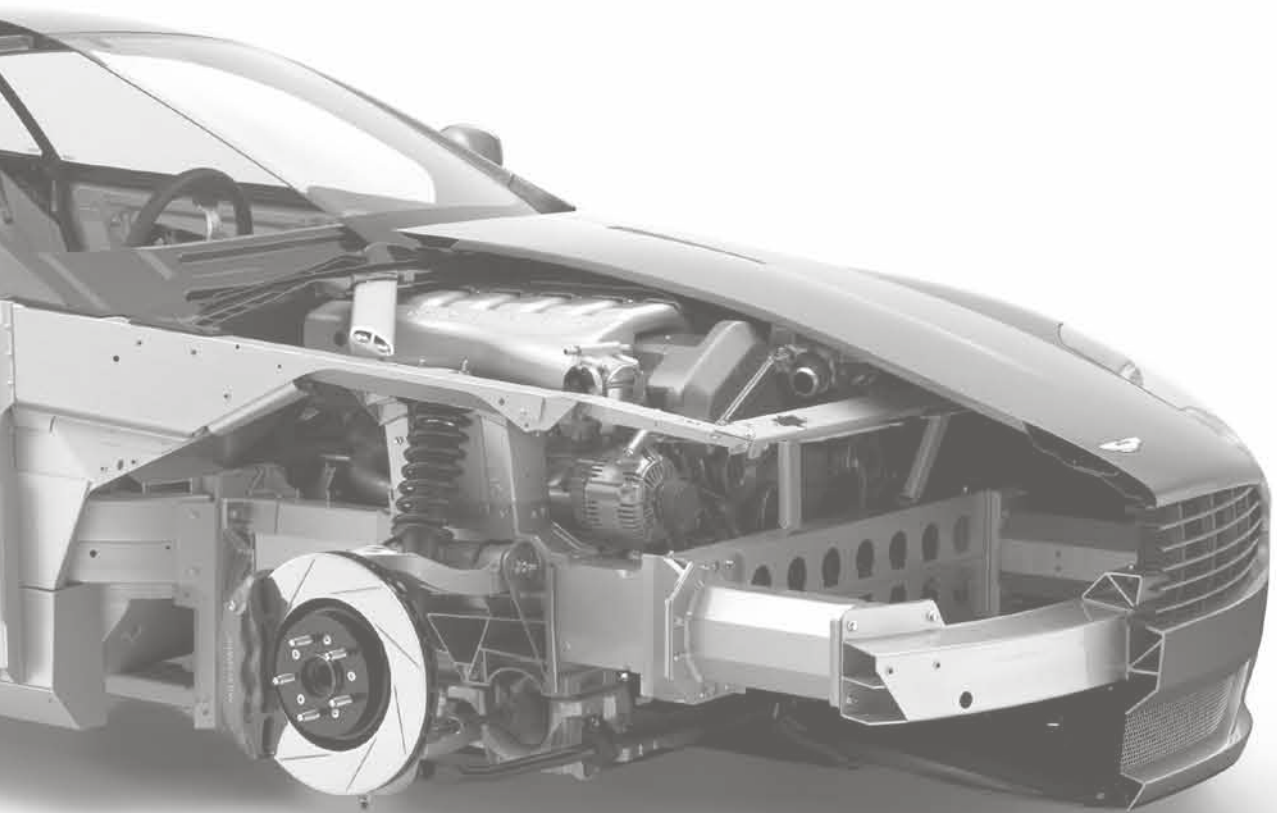



ENGINEERING

The DB9 is technologically sophisticated and meticulously engineered. Its development programme included rigorous testing in locations as diverse as Nardo in Italy, Death Valley in the USA and inside the Arctic Circle in Sweden. In total, more than one million testing miles have been covered. Design and engineering innovations include the Organic Electroluminescent displays (OEL) in the instrument pack and centre console, which provide greater clarity and resolution, as well as LED (light-emitting diode) rear lamps designed to project further and react more quickly than conventional systems.

The propeller shaft is particularly innovative: it is manufactured from carbon-fibre for lightness and improved transmission refinement. The 'swan-wing' doors are another elegant and ingenious design feature, opening out and up to improve access and prevent the doors from being scuffed on high kerbs. The DB9 also pioneered the use of 'ultrasonic' welding, which is 90 per cent stronger than conventional spot welding and results in a better finish, yet uses only five per cent of the energy.

Aston Martin has developed its own incredibly light and strong aerospace derived bonded aluminium structure. This unique VH (Vertical Horizontal) structure gives the DB9 one of the most structurally efficient body frames in the car industry. Its huge rigidity aids handling, driver feedback and safety. More than any other single component, the advanced aluminium structure is the reason for the DB9's extraordinary nimbleness, responsiveness and character.

However, it is not just the body structure that is light and rigid. Other components have been developed with weight reduction in mind, from the aluminium V12 engine and transmission to the forged aluminium suspension and aluminium-bodied dampers. Even the windscreen surround is cast aluminium, while the door frames and inner panels, steering column and gear change paddles are all made from magnesium.

The result is that the DB9 is up to 590 kg (1300 lb) leaner than some other GT cars. That's the equivalent of six average weight adult males, plus luggage. This light weight, allied to class-leading rigidity, contributes to improved acceleration, agility, steering response, braking and fuel economy, as well as a significantly heightened driving experience. Lightness and balance make the whole driving experience more pleasurable – from the deft movement needed to open and close the graceful, 'swan-wing' doors, to the touch and feel of every control on the dashboard. The DB9, more than almost any other sports car, is in harmony with its driver, and in harmony with the road.



CRAFTSMANSHIP

The DB9 is elegant, luxurious and supremely comfortable. Its cabin is hand-trimmed in beautiful, natural materials – primarily wood and leather – and incorporates the latest in modern technology without resorting to superfluous controls or displays. There is a minimum of distraction – even the satellite navigation screen folds discreetly away when not in use. Every element of the interior is hand-made and hand-finished, from the cutting of the leather to the carefully crafted wood. This is done not out of deference to tradition, but because a skilled craftsman can finish wood or leather to a far higher standard than any machine. The leather is particularly soft and supple, as you would expect of Aston Martin, and is used throughout the cabin.

The wood trims are inspired by hand-finished modern furniture and there is a choice of five: Walnut, Mahogany, Bamboo, Tamo Ash and Piano Black. In every case, 'single-piece' cuts are used, rather than tiny strips or thin appliqué. Crafting such large pieces of wood is only possible when done by hand.

The use of aluminium on the dashboard, instrument panel, centre console and door handles reflects the aluminium structure that underpins the entire car. The finish is stylish and contemporary, yet the material itself is steeped in automotive tradition.

The DB9 has exceptional equipment levels, as one would expect in a high-performance sports car with GT levels of comfort and refinement. The driver's first interaction with the powerful V12 engine is a blend of tradition and high technology, with a touch of theatre. The ignition is controlled by a stainless steel and glass ECU (Emotion Control Unit), designed to be as tactile and refined as a fine timepiece. The ECU is inserted into a special docking station set within the traditional clear glass starter button. Pressing the ECU flush with the surface of the starter button fires the engine. After pressing once again to stop the engine, the ECU rises out of its slot within the button so that it can be removed.

The centre console has clear, crisp graphics, with a traditional analogue clock at the centre flanked by rotary controls for the heating and air-conditioning system. These solid, turned aluminium controls also operate the audio system, integrated Bluetooth telephone and ultra-quick Hard Disk Drive (HDD) satellite navigation functions.

Audio is provided by the 700 W Premium Audio System with Dolby® Pro Logic II®. Tailored for Aston Martin, this system features high-quality, fibre-optic electronics, which pass audio signals with marvellous precision and near-perfect clarity. The console also includes a slot for the six-CD autochanger, while beneath the centre armrest there is connectivity for iPod and MP3 players.

Full Bluetooth integration is standard on the DB9, enabling you to synchronise your mobile telephone directory through the car's display screens. It can also display the last 10 calls received, made and missed.

Aston Martins are hand-built cars, made to order, and this bespoke approach enables the provision of a myriad of paint and leather trim colours and combinations. There is, however, an extensive palette of standard body colours and interior finishes, carefully chosen by Aston Martin's design team to complement the forms, materials and surfaces of the car.

Twenty-four standard paint colours are available, categorised as 'contemporary', 'fast track' or 'special', and varying from subtle metallics to the brightest hues. In addition, 20 shades of the finest, softest leather, nine colours of carpet, five choices of wood trim and two choices of metal fascia trim complete the standard range. For the DB9 Volante, there are eight hood colours available, from Black to Sandstorm.

Standard features include satellite navigation (where available), front and rear parking sensors, Bluetooth telephone connectivity, cruise control, Adaptive Damping System (ADS), powerfold mirrors, tyre-pressure monitoring, diamond turned alloy wheels and heated front seats. Additional options are available, including Bang and Olufsen BeoSound audio system and personalised sill plaques.

The DB9 was the first Aston Martin to be produced at the company's factory at Gaydon in Warwickshire. Hand-built by technicians and craftsmen at a series of work stations, it benefits from the superior levels of finish and exclusive design details that would be impossible in a mass-produced car. The paintwork of each DB9 undergoes 50 man hours of painting, polishing and finishing to achieve the perfect surface.

Aston Martin is one of the world's most distinguished sports car manufacturers. It has produced exclusive, hand-crafted sports cars for over 90 years. In that time, just over 50,000 Aston Martins have been built and more than 80 per cent are still in use, cherished, driven and raced by enthusiastic owners around the world.

The founders of the company, Lionel Martin and Robert Bamford, had a clear vision: to create sports cars with a distinctive character; cars built to a high standard that were exhilarating to drive and own; cars with power, beauty and soul. Those values remain integral to our approach.

In 1947, Aston Martin was acquired by industrialist David (later Sir David) Brown, and soon produced the first of the famous 'DB' series of cars. These iconic models were among the most beautiful and desirable of all sports cars of the 1950s and 1960s and helped define Aston Martin's image and ethos, as well as securing its long-term future.

David Brown's period of ownership also saw Aston Martin win at Le Mans in 1959, with the DBR1, and secure victory in that year's World Sportscar Championship.

In 1964, Aston Martin made its big-screen debut when a specially customised DB5 starred alongside Sean Connery in Goldfinger, the third James Bond film. More than 40 years on, the special relationship with 007 is still going strong – the legendary British secret agent drives an Aston Martin in both Casino Royale and Quantum of Solace.

DBR1

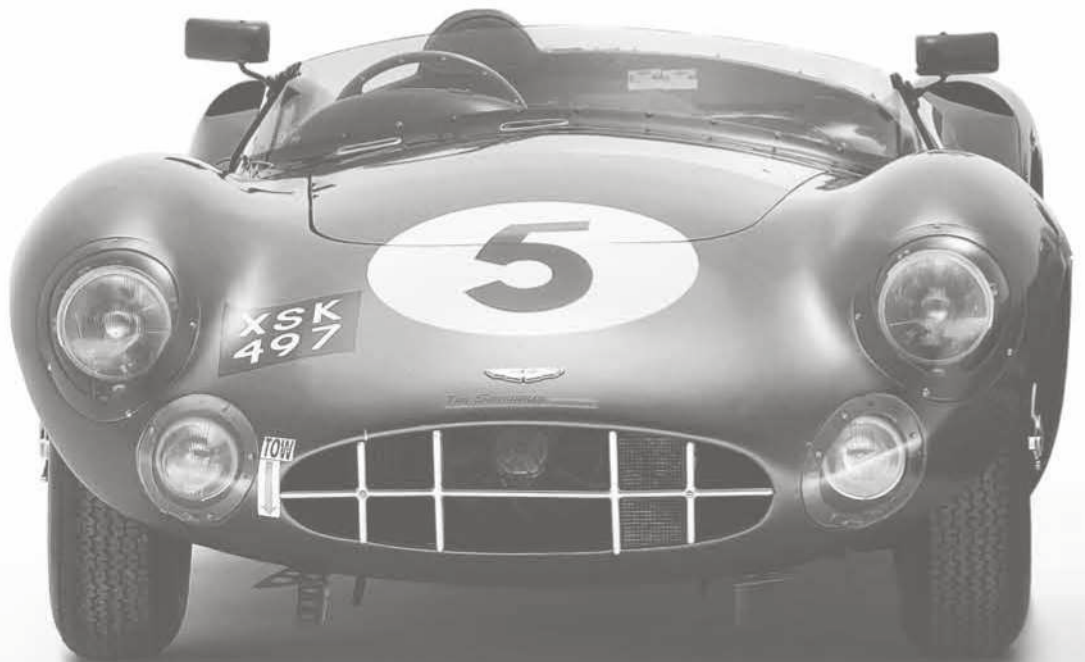

Racing remains firmly intertwined with the company's DNA. Aston Martin made an evocative return to international sports car racing in 2005 when a Works-prepared DBR9 took class honours on its debut at the 12 Hours of Sebring before confirming its ability by winning the famous Tourist Trophy outright at Silverstone. The main objective, however, was always victory at the Le Mans 24 Hours – a feat achieved in 2007 and 2008 when the DBR9 overcame its GT1 rivals to further Aston Martin's enviable racing pedigree. For 2009, Aston Martin entered the premier LMP1 class at Le Mans with a new, purpose-built car powered by the same production-based V12 engine that powers the DB9. Aston Martin finished a creditable fourth overall and, significantly, was the highest-placed petrol-fuelled car. It then went on to win outright the second round of the Asian Le Mans Series in Japan and to secure overall team and driver titles in the European Le Mans Series after finishing on the podium in all five of the Series races.

A production version of Aston Martin's V12 Vantage, powered by a standard V12 engine, won its class first time out at the gruelling Nürburgring 24-Hour race in 2009. In addition, Aston Martin is the only manufacturer to offer a production-based racing car in all four FIA-sanctioned sports car classes (GT1, GT2, GT3 and GT4), all of which have enjoyed considerable success around the world.

Customers are invited to share in this heritage: a visit to the HQ and factory at Gaydon in Warwickshire forms an important part of the unique Aston Martin buying experience.



DBR9

SPECIFICATION

1 Not available in all markets.

2 Includes Traffic Messaging Channel (TMC) in Continental Europe.

3 Complies with UK Thatcham Category 5 requirements. Excludes subscription. Standard in UK.

4 iPod is a trademark of Apple Inc., registered in the US and other countries

5 ICEpower® is a proprietary technology of Bang & Olufsen Audio System

6 Not available with Bang & Olufsen audio system

7 Data not applicable to North American market.

Body

- Two-door coupe or convertible body style with 2+2 seating
- Extruded aluminium bonded VH body structure
- Aluminium and composite body panels
- Extruded aluminium door side-impact beams
- High Intensity Discharge (HID) headlamps (dipped beam)
- Halogen projector headlamps (main beam) with power wash
- LED rear lamps

Engine

- Alloy, quad overhead camshaft, 48-valve, 5935 cc V12
- Front mid-mounted engine, rear wheel drive
- Fully catalysed stainless steel exhaust system with active bypass valves
- Compression ratio 10.9:1
- **Max power** 350 kW (470 bhp/477 PS) at 6000 rpm
- **Max torque** 600 Nm (443 lb ft) at 5000 rpm
- **Acceleration** – manual and automatic 0-60 mph in 4.6 sec; 0-100 km/h (0-62 mph) in 4.8 sec
- **Max speed** 306 km/h (190 mph)

Transmission

- Rear mid-mounted, six-speed manual gearbox
- Rear mid-mounted, 'Touchtronic 2' six speed automatic with electronic shift-by-wire control system
- Alloy torque tube with carbon-fibre propeller shaft
- Limited-slip differential
- Final-drive ratio – manual 3.54:1
- Final-drive ratio – automatic 3.154:1

Steering

- Rack and pinion, Servotronic speed-sensitive power-assisted steering, 3.0 turns lock-to-lock
- Column tilt and reach adjustment

Wheels & tyres

- 19" 20-spoke diamond turned cast alloy road wheels with Silver finish
- **Front** 8.5J x 19" Bridgestone Potenza 235/40 ZR19
- **Rear** 9.5J x 19" Bridgestone Potenza 275/35 ZR19

Suspension

- **Front** Independent aluminium double wishbones incorporating anti-dive geometry, coil over aluminium monotube dampers and anti-roll bar
- **Rear** Independent aluminium double wishbones incorporating anti-squat and anti-lift geometry, coil over aluminium monotube dampers and anti-roll bar
- Adaptive damping system

Brakes

- **Front** Ventilated and grooved steel discs, 355 mm diameter
- **Rear** Ventilated and grooved steel discs, 330 mm diameter
- Radial-mounted four-piston monobloc calipers
- Dynamic Stability Control (DSC)
- Anti-lock Braking System (ABS)
- Electronic Brakeforce Distribution (EBD)
- Emergency Brake Assist (EBA)
- Traction control

Interior

- Full grain leather interior
- Walnut fascia trim
- Iridium Silver centre console outer finish and Graphite inner finish
- Auto-dimming interior rear-view mirror¹
- Auto-dimming interior rear-view mirror with garage door opener (USA and Canada only)
- Electrically operated seats
- Memory seats and exterior mirrors (three positions)
- Dual-stage driver and front passenger frontal airbags
- Front occupant side airbags
- Automatically deployed roll-over bars (Volante)
- Heated front seats
- Heated rear screen
- Automatic temperature control
- Organic Electroluminescent (OEL) displays
- LED map lamps and ambient lighting
- Trip computer
- Cruise control
- Hard Disk Drive (HDD) satellite navigation^{1,2}
- Bluetooth telephone preparation¹
- Satellite radio system (USA only)
- Powerfold exterior mirrors
- Rear parking sensors
- Tyre-pressure monitoring¹
- Alarm and immobiliser
- Remote-control central door locking and boot release
- Wind deflector (Volante only)
- Tracking device³ (UK only)
- Boot-mounted umbrella
- Lamy pen and pen holder (manual only)

In-car entertainment

- Aston Martin 700 W Premium Audio System with Dolby® Pro Logic II® and a six-CD autochanger
- MP3 player connectivity
- Integrated Apple iPod® connector⁴
- USB connector with Waveform Audio Format (WAF), Windows MediaPlayer (WMA) and MPEG (MP3) audio file compatibility
- 3.5 mm auxiliary input socket

Options

- 1000 W Bang & Olufsen BeoSound Audio System with 1000 W RMS of ICEpower®5 amplification
- Front parking sensors
- Perforated leather seat inserts
- Mahogany fascia trim
- Bamboo fascia trim
- Tamo Ash fascia trim
- Piano Black fascia trim
- Nexus Alloy fascia trim
- Double Apex fascia trim
- Matching wood door trim⁶
- Second glass key
- Personalised sill plaques
- Magnum Silver bonnet, side strake and lower bumper meshes
- Polished alloy treadplates
- Auto-dimming interior rear-view mirror with garage door opener (Europe only)
- Alarm upgrade (volumetric and tilt sensor)
- Tracking device^{1,3}
- Alternative brake caliper finish – black, red and grey
- 19" 20-spoke diamond turned cast alloy road wheels with Graphite finish
- 19" 5-spoke diamond turned forged alloy road wheels
- 19" 10-spoke diamond turned forged alloy road wheels with Silver finish
- 19" 10-spoke diamond turned forged alloy road wheels with Graphite finish
- First-aid kit
- Smokers' pack
- Satellite radio system (Canada only)

Dimensions

- **Length** 4710 mm (185.5")
- **Width** 1875 mm (74")
- **Height** 1270 mm (50")
- **Wheelbase** 2745 mm (108")
- **Front track** 1570 mm (62")
- **Rear track** 1560 mm (61.5")
- **Turning circle** 12.0 m (39.4 ft)
- **Fuel capacity** 80 ltr (17.6 UK gal, 21.1 US gal)
- **Cd** (Coupe) 0.35
- **Kerb weight** (Coupe) 1760 kg (3880 lb)

Fuel consumption⁷ – manual

Litres/100 km (mpg)

- **Urban** 24.6 (11.5)
- **Extra-urban** 11.7 (24.1)
- **Combined** 16.4 (17.2)

Fuel consumption⁷ – automatic

Litres/100 km (mpg)

- **Urban** 22.3 (12.7)
- **Extra-urban** 10.2 (27.8)
- **Combined** 14.6 (19.4)

Gas mileage (North America only) – manual

- **City** 11 mpg
- **Highway** 17 mpg

Gas mileage (North America only) – automatic

- **City** 13 mpg
- **Highway** 19 mpg

CO₂ emissions⁷

- 389 g/km – manual
- 345 g/km – automatic

Aston Martin Lagonda Limited,
Banbury Road, Gaydon,
Warwickshire, CV35 0DB England
Telephone +44 (0)1926 644644
Facsimile +44 (0)1926 644333
www.astonmartin.com

IMPORTANT NOTICE Aston Martin Lagonda Limited is constantly seeking ways to improve the specification, design and production of its vehicles and alterations take place continually. Whilst every effort is made to produce up-to-date literature, this brochure should not be regarded as an infallible guide to current specifications, nor does it constitute an offer for sale of any particular vehicle. The contents of this brochure represent the Company's business as a whole. Text and photographs may relate to models not available for sale in some countries. Performance results may vary depending on the specification of the particular vehicle, road and environmental conditions and driving style. Published figures should be used for comparison purposes only and verification should not be attempted on public roads. Aston Martin Lagonda Limited strongly urges that all speed laws be obeyed and that safety belts be worn at all times. Distributors and dealers are not agents of Aston Martin Lagonda Limited and have absolutely no authority to bind Aston Martin Lagonda Limited by any express or implied undertaking or representation.

PART NO: 704672

Concept by Aston Martin.
DB9 photography by René Staud Studios.
Lifestyle photography by Patrick Curtet
and René Staud Studios.
Produced by Worix.



ASTON MARTIN

WWW.ASTONMARTIN.COM

