



Book a [▶ test drive](#)  
[▶ AMG test drive](#)



[▶ Find a Retailer](#)

# S-Class

Saloon



Effective from December 2019 Production.

Mercedes-Benz





Book a [test drive](#)  
[AMG test drive](#)



[Find a Retailer](#)

# Contents

|   |   |                                  |
|---|---|----------------------------------|
| <b>8</b> Model prices                                   | <b>26</b> Standard equipment                  | <b>41</b> Genuine Accessories    |
| <b>9</b> Model lines                                    | <b>34</b> Wheels                              | <b>44</b> Colours and materials  |
| <b>14</b> BP Chargemaster Homecharge                    | <b>35</b> AMG Night package                   | <b>53</b> Technical data         |
| <b>15</b> Mercedes-AMG models                           | <b>36</b> Exclusive Nappa Leather package     | <b>61</b> Road Fund Licence      |
| <b>22</b> Mercedes-AMG driver training                  | <b>37</b> AMG Exclusive Nappa Leather package | <b>62</b> Services and insurance |
| <b>23</b> Executive equipment line                      | <b>38</b> Driving Assistance package          | <b>63</b> Mercedes me            |
| <b>24</b> Rear Luxury Lounge equipment line             | <b>39</b> Individual Rear Seats package       | <b>65</b> Mercedes-Benz Finance  |
| <b>25</b> Pricing summary for model and equipment lines | <b>40</b> Optional equipment                  |                                  |





Book a [▶ test drive](#)  
[▶ AMG test drive](#)



[▶ Find a Retailer](#)

3



# Trailblazing.

The S-Class marks a milestone  
of innovation and driving luxury.





Book a [test drive](#)  
[AMG test drive](#)



[Find a Retailer](#)

4



# Modern luxury.

The epitome of ultimate comfort  
and driver assistance.





Book a [▶ test drive](#)  
[▶ AMG test drive](#)



[▶ Find a Retailer](#)

# Cutting edge.

The perfect balance of power and efficiency.







Book a [▶ test drive](#)  
[▶ AMG test drive](#)



[▶ Find a Retailer](#)

# Breathtaking.

*The performance luxury saloon.*







Book a [> test drive](#)  
[> AMG test drive](#)



[> Find a Retailer](#)

# A class of its own.

7



The Mercedes-Maybach S 650  
with refined V12 performance.

For more information  
click the website link



download the  
ebrochure





# Model prices

| Model line                  | Engine  | Transmission                                      | CO <sub>2</sub><br>WLTP <sup>1,*</sup> | Basic RRP<br>excl. VAT | Total RRP<br>incl. VAT | Road Fund<br>Licence WLTP <sup>2</sup> | Rec. OTR<br>price WLTP <sup>3</sup> | P11D<br>value | BiK tax rate 2019/20 |                    |
|-----------------------------|---|---|--|------------------------|------------------------|--|-------------------------------------|---------------|----------------------|--------------------|
|                             |   |   |  |                        |                        |  |                                     |               | (pre 6 April)        | (on/after 6 April) |
| Grand Edition               | <b>S 350 d</b><br>Diesel – 2,925 cc, 6-cylinder, 286 hp/210kW                                     | 9G-TRONIC<br>9-speed automatic                    | 180                                    | £62,116.67             | £74,540.00             | £1,305.00                              | £76,640.00                          | 75,280.00     | 37%                  | 37%                |
|                             | <b>S 350 d L</b><br>Diesel – 2,925 cc, 6-cylinder, 286 hp/210kW                                   | 9G-TRONIC<br>9-speed automatic                    | 181                                    | £64,450.00             | £77,340.00             | £1,305.00                              | £79,444.00                          | 78,080.00     | 37%                  | 37%                |
|                             | <b>S 400 d L</b><br>Diesel – 2,925 cc, 6-cylinder, 340 hp/250 kW                                  | 9G-TRONIC<br>9-speed automatic                    | 181                                    | £67,783.34             | £81,340.00             | £1,305.00                              | £83,440.00                          | 82,080.00     | 37%                  | 37%                |
|                             | <b>S 450 L</b><br>Petrol – 2,999 cc, 6-cylinder, 367 hp/270 kW<br>EQ Boost – 22 hp/16 kW          | 9G-TRONIC<br>9-speed automatic                    | 187                                    | £67,916.67             | £81,500.00             | £870.00                                | £83,165.00                          | 82,240.00     | 37%                  | 37%                |
|                             | <b>S 500 L</b><br>Petrol – 2,999 cc, 6-cylinder, 435 hp/320 kW<br>EQ Boost – 22 hp/16 kW          | 9G-TRONIC<br>9-speed automatic                    | 187                                    | £72,291.67             | £86,750.00             | £870.00                                | £88,415.00                          | 87,490.00     | 37%                  | 37%                |
|                             | <b>S 560 e L</b><br>Petrol – 2,996 cc, 6-cylinder, 367 hp/270 kW<br>Electric motor – 122 hp/90 kW | 9G-TRONIC<br>9-speed automatic                    | 56                                     | £80,625.00             | £96,750.00             | £15.00                                 | £97,560.00                          | 97,490.00     | 16%                  | 14%                |
| <b>Mercedes-AMG</b>         | <b>Mercedes-AMG S 63 L</b><br>Petrol – 3,982 cc, 8-cylinder, 612 hp/450 kW                        | AMG SPEEDSHIFT<br>MCT 9-speed<br>sports automatic | 270                                    | £105,437.50            | £126,525.00            | £2,175.00                              | £129,495.00                         | £127,265.00   | 37%                  | 37%                |
| <b>Mercedes-AMG Premium</b> | <b>Mercedes-AMG S 63 L</b><br>Petrol – 3,982 cc, 8-cylinder, 612 hp/450 kW                        | AMG SPEEDSHIFT<br>MCT 9-speed<br>sports automatic | 271                                    | £112,933.34            | £135,520.00            | £2,175.00                              | £138,490.00                         | £136,260.00   | 37%                  | 37%                |

<sup>1</sup>The indicated values were determined according to the prescribed measurement method – Worldwide Harmonised Light Vehicle Test Procedure (WLTP). Figures shown may include options which are not available in the UK.

For Plug-in Hybrid Electric Vehicle (PHEV) figures determined with the battery fully charged, using a combination of both battery power and fuel. These models require mains electricity for charging

\*Figures shown are for comparability purposes; only compare with other cars tested to the same technical procedures. Figures may not reflect real life driving results, which will depend upon a number of factors including the starting charge of the battery, factory-fitted options, accessories fitted (post registration), variations in weather, driving styles and vehicle load. Further information about the test used to establish fuel consumption and CO<sub>2</sub> figures can be found at <http://www.mercedes-benz.co.uk/WLTP>

<sup>2</sup>A different first year rate of Vehicle Excise Duty (Road Fund Licence) applies for new cars. Please refer to page 61 for the relevant rate for the second and subsequent years

<sup>3</sup>The recommended on-the-road price includes the Road Fund Licence applicable to the standard model plus delivery charge (£715.00 incl. VAT), new vehicle registration fee (£55.00) and number plates (£25.00 incl. VAT). VAT is calculated at the standard rate of 20%





Book a [▶ test drive](#)  
[▶ AMG test drive](#)



[▶ Find a Retailer](#)

# S-Class Grand Edition





Book a [test drive](#)  
[AMG test drive](#)



[Find a Retailer](#)



10







The new S-Class Grand Edition is packed with an impressive amount of exterior and interior features, and can easily be recognised by the 20" AMG alloy wheels with 10-spoke design in high-gloss black, an electric panoramic sunroof, and the 'Grand Edition' badging on both front wings. The Burmester®

surround sound system ensures an unmistakable and outstanding sound experience while enjoying the luxury of the comfort-ventilated active multi-contour front seats with massage function.

#### Exterior

- KEYLESS-GO Comfort package
- 9G-TRONIC transmission with steering column gear selector, steering wheel gearshift paddles (Direct Select) and SPEEDTRONIC cruise control
- 20" AMG alloy wheels – 10-spoke design painted high-gloss black
- 360° camera
- AMG bodystyling – front apron, rear apron and side skirts
- Charging cable for household socket (4 m)<sup>1</sup>
- Charging cable for wall box and public charging stations (4 m)<sup>1</sup>
- Closing aid for doors and boot lid
- Downward projection of Mercedes-Benz logo from front (and rear<sup>2</sup>) doors
- Electric panoramic glass sunroof
- 'Grand Edition' badging on front wings
- Heat-insulating dark-tinted glass
- MAGIC VISION CONTROL – adaptive windscreen wiper system
- MULTIBEAM LED headlamps with ULTRA RANGE Highbeam

#### Interior

- AIR-BALANCE package – fragrance generator with perfume flask in glove compartment  
Please refer to page 43 for more details
- Front Seat Memory package
- 3-spoke multifunction steering wheel in nappa leather with touch control steering wheel pads
- Active multi-contour front seats with dynamic and massage functions
- Ambient lighting – choice of 64 colour settings
- Burmester® surround sound system
- COMAND Online system with 12.3-inch media display
- Comfort-ventilated front seats, including seat heating
- Dual-bonded widescreen cockpit display (12.3-inch)
- ENERGIZING Comfort
- Nappa leather interior upholstery
- Smartphone integration with Android Auto and Apple CarPlay™
- Wireless phone charging – front<sup>3</sup>

#### Trim and Upholstery

designo open-pore black ash wood



Nappa leather – black



Nappa leather – silk beige/espresso brown



Nappa leather – nut brown/black



Nappa leather – porcelain/black



Nappa leather – magma grey/espresso brown



Please refer to page 44 for the full range of trim and upholstery choices

<sup>1</sup>S 560 e L only <sup>2</sup>LWB only <sup>3</sup>Compatible mobile phone required



Book a [▶ test drive](#)  
[▶ AMG test drive](#)



[▶ Find a Retailer](#)

12

## S 560 e L plug-in hybrid







Book a [test drive](#)  
[AMG test drive](#)



[Find a Retailer](#)

S 560 e L plug-in hybrid

13

Combining the best of both worlds, this new S-Class plug-in hybrid offers excellent performance while keeping emissions to a minimum. The hybrid drive system in the S 560 e L combines the 367 hp (270 kW) of the V6 combustion engine with an electric output of 90 kW. Intelligent technology, courtesy of the third-generation EQ Power hybrid transmission, makes for smooth gear changes. Meanwhile, ECO Assist promotes anticipatory, econo-

mical driving. The S 560 e L has an all-electric range of around 30 miles. In conjunction with a wall box charger, the car's 7.2 kW on-board charger allows fast charging of the battery in just two hours.

The S 560 e L plug-in hybrid is available as a Grand Edition.





Book a  
 > test drive  
 > AMG test drive



> Find a Retailer

# BP Chargemaster Homecharge – simple, convenient, faster charging

Mercedes-Benz plug-in vehicle customers with off-street parking can benefit from the convenience and speed of charging at home by installing a BP Chargemaster Homecharge unit. The 7 kW BP Chargemaster Homecharge unit delivers a full charge in just two hours – that’s twice as fast as using a 13 A three-pin domestic plug.<sup>1</sup>

BP Chargemaster Homecharge 7 kW: **£499\*** incl. VAT & installation



## Key benefits of the 7 kW BP Chargemaster Homecharge:

Robust and weatherproof, for indoor or outdoor use, and comes with a three year warranty

Installed in as little as two weeks

The cost for a fully-installed charge point at your home includes the £350 OLEV (EVHS) grant<sup>2</sup>

As a Mercedes-Benz driver, when you install a BP Chargemaster Homecharge unit you will automatically receive three months FREE membership to POLAR plus, the UK’s largest public charging network with over 6,500 charge points

## Questions?

- Simply email [mercedes-benz@chargemasterplc.com](mailto:mercedes-benz@chargemasterplc.com) or
- call their dedicated Homecharge team on 01582 399 412

## !Warning

If you are planning to charge your Mercedes-Benz plug-in electric vehicle using a 3-pin domestic plug socket you must get a qualified electrician to inspect and sign off the socket to confirm it is safe and suitable to charge your vehicle. Do not use an electric vehicle 3-pin charge cable with an extension cord.

bp  
**chargemaster**

\*Price includes £350 OLEV EVHS Grant. Price correct at time of publication, subject to change <sup>1</sup>Based on 7kW power output for plug-in hybrid vehicles

<sup>2</sup>The BP Chargemaster Homecharge £350 Grant (including VAT) is only available to customers who meet the criteria of the Office of Low Emission Vehicles (OLEV) and is provided and installed by BP Chargemaster plc. For full details and eligibility criteria for the OLEV EVHS Grant, see <https://www.gov.uk/government/publications/electric-vehicle-homecharge-scheme-guidance-for-customers-version-21>. For full BP Chargemaster Homecharge Terms & Conditions visit [https://chargemasterplc.com/terms\\_conditions](https://chargemasterplc.com/terms_conditions)





Book a [▶ test drive](#)  
[▶ AMG test drive](#)



[▶ Find a Retailer](#)

# Mercedes-AMG S 63 L





Book a [test drive](#)  
[AMG test drive](#)



[Find a Retailer](#)



Option: red painted brake calipers (code U70) are available only on Mercedes-AMG S 63 L Premium





The 'V8 BITURBO' lettering, 20" AMG alloy wheels in a 10-spoke design, as well as AMG bodystyling in jet black and high-gloss chrome are all part of the powerful new Mercedes-AMG S 63 L. AMG nappa leather sports seats with AMG V8 styling are combined with a 3-spoke AMG sports steering

wheel featuring aluminium gearshift paddles. The AMG dual-bonded widescreen cockpit display brings together all things multimedia including COMAND Online and the Burmester® surround sound system.

#### Exterior

KEYLESS-GO Comfort package

20" AMG alloy wheels – 10-spoke design with 255/40 front and 285/35 rear tyres

Active Parking Assist including PARKTRONIC and 360° camera

AMG front apron with black-painted jet wing and trim strip in high-gloss chrome

AMG radiator grille in high-gloss chrome with AMG lettering

AMG SPEEDSHIFT MCT 9-speed sport transmission

MULTIBEAM LED with ULTRA RANGE Highbeam

'V8 BITURBO' lettering on the front wings

#### Interior

AMG dual-bonded widescreen cockpit display (12.3-inch)

AMG floor mats with 'AMG' lettering

AMG nappa leather sports seats with AMG V8-specific seat layout, optimised lateral support and AMG badge in front and rear backrests

AMG sports steering wheel in 3-spoke design in nappa leather with perforated grip area, 12 buttons, decorative topstitching and silver-coloured aluminium gearshift paddles

Ambient lighting – choice of 64 colour settings

Burmester® surround sound system

COMAND Online system with 12.3-inch media display

Comfort-ventilated front seats, including seat heating

Illuminated AMG door sill panels with 'AMG' lettering at front and rear

#### Trim and Upholstery

Black poplar wood



Nappa leather – black



Nappa leather – silk beige/espresso brown



Nappa leather – nut brown/black



Nappa leather – porcelain/black



Nappa leather – magma grey/espresso brown



Please refer to page 44 for the full range of trim and upholstery choices



Book a [▶ test drive](#)  
[▶ AMG test drive](#)



[▶ Find a Retailer](#)

# Mercedes-AMG S 63 L Premium







Book a [▶ test drive](#)  
[▶ AMG test drive](#)



[▶ Find a Retailer](#)



Optional features: anthracite blue paint (code 889), porcelain/deep sea blue designo Exclusive nappa leather (code 585A) and silk matt grey ash wood trim (code H30)





Book a [▶ test drive](#)  
[▶ AMG test drive](#)



[▶ Find a Retailer](#)



Panoramic roof with MAGIC SKY CONTROL



Model lines | Mercedes-AMG S 63 L Premium

20

Burmester® high-end 3D surround sound system



Head-up display



Warmth Comfort package



The Mercedes-AMG S 63 L Premium focuses on the finer details to elevate the driving experience. The exterior is transformed through the striking 20" forged AMG alloy wheels complemented by the red-painted brake calipers.

The interior is crowned by the stunning finishing touches; from the panoramic roof with MAGIC SKY CONTROL through to the Burmester® high-end 3D surround sound system.

*In addition/replacement to Mercedes-AMG S 63 L:*

**Exterior**

20" AMG alloy wheels – forged cross-spoke design

MAGIC SKY CONTROL

Red-painted brake calipers

**Interior**

Roller Blind package with electrically operated blinds for rear and side windows (code P09)

Winter package

Armrest heating in front, rear and centre console

Head-up display

Heated multifunction AMG Performance steering wheel

Burmester® high-end 3D surround sound system

**Trim and Upholstery**

Black poplar wood<sup>1</sup>



Brown burr walnut wood<sup>1</sup>



Nappa leather – black



Nappa leather – porcelain/espresso brown



Please refer to page 44 for the full range of trim and upholstery choices

<sup>1</sup>Choice of either black poplar or brown burr walnut wood trim





Book a  
▶ test drive  
▶ AMG test drive



▶ Find a Retailer

# Become the AMG expert

Unleash a new level of performance.

All Mercedes-AMG customers are invited to a complimentary adrenaline-packed driving experience, under the guidance of our driving specialists at Mercedes-Benz World.



## Discover AMG at Mercedes-Benz World

- Individually tailored to your ability
- No previous track experience necessary
- See how well an AMG performs when pushed to its limits
- Put your theoretical driving knowledge to the test on a real track
- Understand the cause and effect of understeer, oversteer drift, collision avoidance and track etiquette
- Get to grips with the Mercedes-Benz World's purpose-built track and dynamic driving facilities

## TERMS AND CONDITIONS

The following customers only are eligible: the first purchaser/registered keeper of a newly registered Mercedes-AMG. The complimentary Training as described in the brochure must be booked and taken within six months of delivery of your Mercedes-AMG. The Training is available Monday to Friday and is subject to availability. Requests for Saturday and Sunday will incur an additional charge. Upgrades are available for an additional cost: details upon request. Transferable to individuals who reside at the same postal address only. Mercedes-Benz Cars UK Limited reserves the right to amend or withdraw this Training experience. Attendees must hold a full UK driving licence. Attendees will be required to sign the Mercedes-Benz World Driving Risk Acknowledgement prior to undertaking the Training experience. The Training experience is also subject to the Mercedes-Benz World Terms and Conditions, as applicable. Invitation is emailed to the customer post-delivery. Permission via the customer contact preferences must be given to enable Mercedes-Benz World to contact. Retailer demonstrator vehicles are not eligible.



## Executive equipment line



With the Executive equipment line, rear passengers can enjoy long journeys in total relaxation. At the touch of a button seats move into a comfortable reclining position, and electrically-operated blinds for the rear and side windows shield the occupants from direct sunlight. And with THERMOTRONIC luxury automatic climate control for the rear they enjoy even greater comfort, since temperature and air distribution can be individually adjusted for the left and right sides. Luxury rear head restraints with an additional comfort cushion ensure the best possible seating comfort for the rear seats.

**Executive equipment line** (code DA1) – designed and priced as a package, including luxury items as listed below.

**All models**

**Total incl. VAT £4,595.00**

---

Backrest angle adjustable up to 37°

---

Closing aid for doors and boot lid<sup>1</sup>

---

Comfort-ventilated rear seats with cooling and heating functions

---

Electrically-operated rear seats with memory function

---

Luxury rear head restraints with additional comfort cushion

---

Roller Blind package with electrically operated blinds for rear and side windows (code P09)

---

THERMOTRONIC – luxury automatic climate control, rear

---

<sup>1</sup>Standard on Grand Edition

Electrically-operated rear seats with memory function, backrest angle adjustable up to 37°



## Rear Luxury Lounge equipment line



If you usually let a chauffeur do the driving for you, another option that's worth considering is the Rear Luxury Lounge, which lets you fold the front passenger's seat right out of the way.

**Rear Luxury Lounge equipment line** (code DP5) – designed and priced as a package, including items listed below.

**All long-wheelbase models**

**Total incl. VAT £4,995.00**

---

2 × wireless headsets

---

Chauffeur position for the front passenger seat, providing more rear legroom on the passenger side

---

Executive rear seat on the front passenger side with electrically-extending leg rest

---

Front passenger seat with extended adjustment

---

Multi-contour rear seats with ENERGIZING massage function including six programmes and two intensities designed to relax, stimulate or energise

---

Rear Seat Entertainment System

---

Rear wireless charging

---

TV tuner

---

Only in conjunction with Executive equipment line (code DA1) or Individual Rear Seats package (code DA2)





## Pricing summary for model and equipment lines Executive and Rear Luxury Lounge

| Models                     | Recommended OTR price (£) <sup>1</sup> |                         |                                  |                                |
|----------------------------|--|-------------------------|----------------------------------|--------------------------------|
|                            | Grand Edition                          | Grand Edition Executive | Grand Edition Rear Luxury Lounge |                                |
| <b>S 350 d</b>             | 76,640.00                              | 81,238.00               | -                                |                                |
| <b>S 350 d L</b>           | 79,440.00                              | 84,035.00               | 89,030.00                        |                                |
| <b>S 400 d L</b>           | 83,440.00                              | 88,035.00               | 93,033.00                        |                                |
| <b>S 450 L</b>             | 83,165.00                              | 87,760.00               | 92,755.00                        |                                |
| <b>S 500 L</b>             | 88,415.00                              | 93,010.00               | 98,005.00                        |                                |
| <b>S 560 e L</b>           | 97,560.00                              | 102,155.00              | 107,150.00                       |                                |
|                            | Mercedes-AMG                           | Mercedes-AMG Executive  | Mercedes-AMG Premium             | Mercedes-AMG Premium Executive |
| <b>Mercedes-AMG S 63 L</b> | 129,495.00                             | 134,090.00              | 138,490.00                       | 143,085.00                     |

<sup>1</sup>The recommended on-the-road price includes the Road Fund Licence applicable to the standard model plus delivery charge (£715.00 incl. VAT), new vehicle registration fee (£55.00) and number plates (£25.00 incl. VAT). VAT is calculated at the standard rate of 20%



Book a [test drive](#)  
[AMG test drive](#)



[Find a Retailer](#)

# Standard equipment



KEYLESS-GO Comfort package



Downward projection of Mercedes-Benz logo from front (and rear – LWB only) doors



MAGIC VISION CONTROL



Ambient lighting – choice of 64 colour settings



Front Seat Memory package



MULTIBEAM LED with ULTRA RANGE Highbeam



Item

Transmission and Suspension

|  | Grand Edition (L) | Mercedes-AMG S 63 L | Mercedes-AMG S 63 L Premium |
|--|-------------------|---------------------|-----------------------------|
| 9G-TRONIC 9-speed automatic transmission with steering column gear selector, steering wheel gearshift paddles (Direct Select) and SPEEDTRONIC cruise control   | ●                 | -                   | -                           |
| AMG SPEEDSHIFT MCT 9-speed sports automatic transmission with RACE START function, ECO start/stop function and four transmission modes: 'C' (Comfort), 'S' (Sport), 'S+' (Sport Plus) and 'I' (Individual) | -                 | ●                   | ●                           |
| AIRMATIC air suspension with level adjustment and Adaptive Damping System  | ●                 | -                   | -                           |
| AMG sports suspension based on AIRMATIC  | -                 | ●                   | ●                           |
| ECO start/stop function  | ●                 | ●                   | ●                           |

Item

Steering

|  | Grand Edition (L) | Mercedes-AMG S 63 L | Mercedes-AMG S 63 L Premium |
|--|-------------------|---------------------|-----------------------------|
| AMG speed-sensitive sports steering  | -                 | ●                   | ●                           |
| Direct Steering  | ●                 | -                   | -                           |
| Steering column - electrically adjustable with EASY-ENTRY function   | ●                 | ●                   | ●                           |
| Steering wheel - 3-spoke multifunction sports steering wheel in black nappa leather, with flattened bottom section, perforated grip area and touch control buttons   | ●                 | -                   | -                           |
| Steering wheel - AMG sports steering wheel in 3-spoke design in nappa leather with perforated grip area, flattened bottom section, trim in silver chrome with 'AMG' lettering and silver-coloured aluminium gearshift paddles, 12 o'clock marking and touch control buttons                                  | -                 | ●                   | -                           |
| Steering wheel - AMG Performance heated multifunction sports steering wheel in 3-spoke design in nappa leather with perforated grip area, flattened bottom section, trim in silver chrome with 'AMG' lettering and silver-coloured aluminium gearshift paddles, 12 o'clock marking and touch control buttons | -                 | -                   | ●                           |





| Item  | Grand Edition (L) | Mercedes-AMG S 63 L | Mercedes-AMG S 63 L Premium |
|---|-------------------|---------------------|-----------------------------|
| <b>Exterior</b>   |                   |                     |                             |
| KEYLESS-GO Comfort package<br>The vehicle can be conveniently unlocked, started and locked with this access and drive authorisation system – simply by carrying the electronic key. The engine can be switched on and off by pressing the start/stop button in the ignition lock.<br>The hands-free access allows hands-off, fully automatic opening and closing of the boot lid by performing a kicking movement under the rear bumper | ●                 | ●                   | ●                           |
| Active Parking Assist including PARKTRONIC and 360° camera  | ●                 | ●                   | ●                           |
| AMG bodystyling – front apron, rear apron and side skirts   | ●                 | –                   | –                           |
| AMG bodystyling<br>Comprising S 63 L-specific front apron with black-painted jet wing and trim strip in high-gloss chrome, AMG radiator grille in high-gloss chrome with ‘AMG’ lettering, AMG rear apron with striking black diffuser insert and two chrome-plated twin tailpipe trim elements  | –                 | ●                   | ●                           |
| AMG high-performance composite brake system with 390×36 mm composite brakes at front and 360 × 26 mm brake discs at rear  | –                 | ●                   | ●                           |
| AMG Performance exhaust system with flap control by means of a button   | –                 | ●                   | ●                           |
| Closing aid for doors and boot lid (standard for S 500 L and S 560 e L only)  | ●                 | ●                   | ●                           |

| Item   | Grand Edition (L) | Mercedes-AMG S 63 L | Mercedes-AMG S 63 L Premium |
|--|-------------------|---------------------|-----------------------------|
| Charging cable for household socket, Type G (Mode 2) – 4 m (S 560 e L only)  | ●                 | –                   | –                           |
| Charging cable for wall box and public charging stations, Type 2 (Mode 3) – 4 m (S 560 e L only)   | ●                 | –                   | –                           |
| Diesel particulate filter (S 350 d/L and S 400 d L only)   | ●                 | –                   | –                           |
| Petrol particulate filter (S 450 L, S 500 L, S 560 e L and AMG S 63 L only)  | ●                 | ●                   | ●                           |
| Exterior mirrors – electrically-adjustable, folding and heated   | ●                 | ●                   | ●                           |
| Electric panoramic glass sunroof   | ●                 | ●                   | ●                           |
| Exhaust system – with visible two-pipe exhaust system in chrome  | ●                 | –                   | –                           |
| ‘Grand Edition’ badging on front wings   | ●                 | –                   | –                           |
| Infrared-reflective, noise insulating glass all round (S 500 L and S 560 e L only)   | –                 | ●                   | ●                           |
| LED tail lights  | ●                 | ●                   | ●                           |
| MAGIC VISION CONTROL – adaptive windscreen wiper system, heated  | ●                 | ●                   | ●                           |
| MULTIBEAM LED with ULTRA RANGE Highbeam<br>LED headlamps with individually controllable LEDs react extremely quickly to the current traffic situation. The partial main beam excludes detected road users – on a free, straight stretch, the ULTRA RANGE Highbeam switches to the legally permitted maximum headlamp range | ●                 | ●                   | ●                           |



Standard equipment

| Item  | Grand Edition (L) | Mercedes-AMG S 63 L | Mercedes-AMG S 63 L Premium |
|---|-------------------|---------------------|-----------------------------|
| <b>Exterior (continued)</b>   |                   |                     |                             |
| Panoramic roof with MAGIC SKY CONTROL   | -                 | -                   | ●                           |
| Projection of Mercedes-Benz logo – downward from front (and rear <sup>1</sup> ) doors | ●                 | -                   | -                           |
| Red-painted brake calipers  | -                 | -                   | ●                           |
| Remote boot lid release   | ●                 | ●                   | ●                           |
| Tinted glass – green  | ●                 | ●                   | ●                           |
| TIREFIT tyre-sealant kit  | ●                 | ●                   | ●                           |
| 'V8 BITURBO' lettering on front wings   | -                 | ●                   | ●                           |

| Item   | Grand Edition (L) | Mercedes-AMG S 63 L | Mercedes-AMG S 63 L Premium |
|--|-------------------|---------------------|-----------------------------|
| <b>Interior</b>  |                   |                     |                             |
| AIR-BALANCE package – fragrance generator with perfume flask in glove compartment<br>Please refer to page 43 for more details  | ●                 | ●                   | ●                           |
| Front Seat Comfort package<br>Active multi-contour seats with dynamic and massage functions  | ●                 | ●                   | ●                           |
| Front Seat Memory package<br>Additional four-way electric lumbar support for front passenger seat<br>Front seats, front head restraints, steering column and exterior door mirrors – electrically adjustable with memory | ●                 | ●                   | ●                           |
| Roller Blind package with electrically operated blinds for rear and side windows (code P09)  | △                 | △                   | ●                           |
| Winter package<br>Armrest heating in front, rear and centre console<br>Head-up display<br>Heated multifunction AMG Performance steering wheel (Mercedes-AMG Premium only)  | △                 | -                   | ●                           |
| 12V socket – on centre console, front and rear, and in boot  | ●                 | ●                   | ●                           |
| Ambient lighting – choice of 64 colour settings  | ●                 | ●                   | ●                           |
| AMG dual-bonded widescreen cockpit consisting of an Instrument Display and Media Display including AMG main menu and AMG start-up screen   | -                 | ●                   | ●                           |
| AMG emblem embossed in front centre armrest  | -                 | ●                   | ●                           |
| AMG illuminated door sill panels in brushed stainless steel at front and rear, with 'AMG' lettering  | -                 | ●                   | ●                           |



Standard equipment

| Item   | Grand Edition (L) | Mercedes-AMG S 63 L | Mercedes-AMG S 63 L Premium |
|--|-------------------|---------------------|-----------------------------|
| <b>Interior (continued)</b>  |                   |                     |                             |
| AMG sports pedals in brushed stainless steel with rubber studs   | ●                 | ●                   | ●                           |
| AMG sports seats with AMG V8-specific seat layout, optimised lateral support and AMG badge in front and rear backrests   | -                 | ●                   | ●                           |
| Analogue clock with Mercedes-Benz star   | ●                 | -                   | -                           |
| AMG-specific IWC-design analogue clock   | -                 | ●                   | ●                           |
| Automatically dimming rear-view mirror and driver's exterior mirror  | ●                 | ●                   | ●                           |
| Brake calipers with 'Mercedes-Benz' lettering in grey  | ●                 | -                   | -                           |
| Brake calipers with 'AMG' lettering in grey  | -                 | ●                   | ●                           |
| Centre armrests - front and rear, with stowage   | ●                 | ●                   | ●                           |
| Cup holders - front (2) and rear (2)   | ●                 | ●                   | ●                           |
| Dual-bonded 12.3-inch widescreen cockpit consisting of an Instrument Display and Media Display   | ●                 | -                   | -                           |
| Electric windows (4) with PRE-SAFE® closing function   | ●                 | ●                   | ●                           |
| ENERGIZING Comfort control - intelligent cross-linking of all comfort systems<br>Drivers can choose from six different expert-configured programmes for activation and relaxation, depending on their personal needs | ●                 | ●                   | ●                           |

| Item   | Grand Edition (L) | Mercedes-AMG S 63 L | Mercedes-AMG S 63 L Premium |
|--|-------------------|---------------------|-----------------------------|
| Floor mats - AMG floor mats with 'AMG' lettering   | ●                 | -                   | -                           |
| Floor mats - AMG Exclusive floor mats with 'AMG' lettering   | -                 | ●                   | ●                           |
| Front seats - comfort-ventilated   | ●                 | ●                   | ●                           |
| Front seats - full electric adjustment<br>Fore and aft, height, inclination and seat cushion length adjustment, electric head restraint height adjustment and four-way electric lumbar support | ●                 | ●                   | ●                           |
| Front seats - heated   | ●                 | ●                   | ●                           |
| Glasses stowage compartment  | ●                 | ●                   | ●                           |
| Glove compartment - lockable, air-conditioned and illuminated  | ●                 | ●                   | ●                           |
| Head restraints, rear (3) - electrically lowering  | ●                 | ●                   | ●                           |
| Illuminated door sill panels   | ●                 | ●                   | ●                           |
| Illuminated vanity mirrors - front and rear  | ●                 | ●                   | ●                           |
| KEYLESS-GO starting function   | ●                 | ●                   | ●                           |
| Load securing rings in boot  | ●                 | ●                   | ●                           |
| Map pockets on front seat backrests  | ●                 | ●                   | ●                           |





| Item  | Grand Edition (L) | Mercedes-AMG S 63 L | Mercedes-AMG S 63 L Premium |
|---|-------------------|---------------------|-----------------------------|
| <b>Interior (continued)</b>   |                   |                     |                             |
| Outside temperature gauge   | ●                 | ●                   | ●                           |
| Parcel nets in boot and front passenger footwell  | ●                 | ●                   | ●                           |
| Rear seats – comfort-ventilated   | △                 | △                   | △                           |
| Rear seats – heated   | ●                 | ●                   | ●                           |
| Rear sill protector – black (S 350 d/S 350 d L/S 400 d L/S 450 L)   | ●                 | –                   | –                           |
| Rear sill protector – stainless steel (S 500 L/S 560 e L)   | ●                 | ●                   | ●                           |
| THERMOTRONIC – luxury automatic climate control, rear   | △                 | △                   | △                           |
| THERMOTRONIC – luxury automatic climate control, two-zone with three climate modes: Focused, Medium and Diffuse | ●                 | ●                   | ●                           |
| Trip computer – in multifunction display, showing current fuel consumption                                      | ●                 | ●                   | ●                           |

| Item   | Grand Edition (L) | Mercedes-AMG S 63 L | Mercedes-AMG S 63 L Premium |
|--|-------------------|---------------------|-----------------------------|
| <b>Paint, Trim and Upholstery</b>                        |                   |                     |                             |
| Dashboard – upper section in ARTICO leather <sup>1</sup> | ●                 | ●                   | ●                           |
| Paint – metallic   | ●                 | ●                   | ●                           |
| Trim – black poplar wood                                 | –                 | ●                   | ●                           |
| Trim – designo open-pore black ash wood                  | ●                 | ○                   | ○                           |
| Upholstery – nappa leather                               | ●                 | ●                   | ●                           |



| Item   | Grand Edition (L) | Mercedes-AMG S 63 L | Mercedes-AMG S 63 L Premium |
|--|-------------------|---------------------|-----------------------------|
| <b>Safety and Assistance Systems</b>   |                   |                     |                             |
| Driving Assistance package<br>Please refer to page 38 for details  | ○                 | ●                   | ●                           |
| Active bonnet – pedestrian safety measure  | ●                 | ●                   | ●                           |
| Adaptive brake lights  | ●                 | ●                   | ●                           |
| Airbags – driver and front passenger   | ●                 | ●                   | ●                           |
| Airbags – front sidebags   | ●                 | ●                   | ●                           |
| Airbags – windowbags   | ●                 | ●                   | ●                           |
| Alarm system with immobiliser and interior protection (MBSS3)<br>Thatcham Category 1 certified                         | ●                 | ●                   | ●                           |
| Anti-lock braking system (ABS) with Brake Assist (BAS)   | ●                 | ●                   | ●                           |
| ATTENTION ASSIST<br>Monitors steering behaviour and can help alert to long journey fatigue                             | ●                 | ●                   | ●                           |
| Automatic child seat recognition sensor<br>Works in conjunction with Mercedes-Benz child seats fitted with transponder | ●                 | ●                   | ●                           |
| Brake pad wear indicator – front brakes  | ●                 | ●                   | ●                           |
| COLLISION PREVENTION ASSIST PLUS   | ●                 | -                   | -                           |
| Crosswind Assist   | ●                 | ●                   | ●                           |
| Electric parking brake   | ●                 | ●                   | ●                           |
| Electronic Stability Programme (ESP®) with Acceleration Skid Control (ASR)   | ●                 | ●                   | ●                           |

| Item   | Grand Edition (L) | Mercedes-AMG S 63 L | Mercedes-AMG S 63 L Premium |
|--|-------------------|---------------------|-----------------------------|
| ESP® Curve Dynamic Assist  | ●                 | ●                   | ●                           |
| First-aid kit  | ●                 | ●                   | ●                           |
| Front passenger seat with PRE-SAFE® positioning function   | ●                 | ●                   | ●                           |
| Headlight Assist – automatic headlight activation  | ●                 | ●                   | ●                           |
| i-Size and ISOFIX child seat fixing points in rear (two outer seats)   | ●                 | ●                   | ●                           |
| Locking wheel bolts  | ●                 | ●                   | ●                           |
| PRE-SAFE® anticipatory occupant protection system  | ●                 | ●                   | ●                           |
| PRE-SAFE® Impulse  | ●                 | ●                   | ●                           |
| Rain-sensing wipers – two-stage  | ●                 | ●                   | ●                           |
| Rear seat belt status indicator  | ●                 | ●                   | ●                           |
| Remote central locking   | ●                 | ●                   | ●                           |
| Seat belts, rear – three-point (3)   | ●                 | ●                   | ●                           |
| Seat belt pre-tensioners, belt force limiters and automatic belt height adjustment – front and outer rear seats            | ●                 | ●                   | ●                           |
| Service indicator ASSYST   | ●                 | ●                   | ●                           |
| Traffic Sign Assist<br>Speed Limit Assist with wrong-way warning function and display of speed limit in instrument cluster | ●                 | ●                   | ●                           |
| Tyre pressure monitoring system  | ●                 | ●                   | ●                           |



| Item   | Grand Edition (L) | Mercedes-AMG S 63 L | Mercedes-AMG S 63 L Premium |
|--|-------------------|---------------------|-----------------------------|
| <b>Communications and In-Car Entertainment</b>   |                   |                     |                             |
| Burmester® surround sound system (standard on AMG Line S 500 L and S 560 e L only)<br>13 speakers and 9-channel DSP amplifier with total output of 590 W   | ●                 | ●                   | -                           |
| Burmester® high-end 3D surround sound system<br>27 speakers and 28-channel amplifier with total output of 1,590 W  | -                 | -                   | ●                           |
| Central controller dial to operate audio functions and telephone (when connected)  | ●                 | ●                   | ●                           |
| COMAND Online system with Media Interface and touchpad<br>Includes DAB radio, 12.3-inch colour display, hard disk drive (HDD) navigation with 3D map display, Live Traffic Information and European map data updates free of charge for the first three years, Speed Limit Assist and LINGUATRONIC voice control. Integrated WLAN hotspot for onboard access of WLAN-enabled devices. Also includes SD memory card slot, 10 GB music register and MP3 compatibility. Bluetooth® interface with high-definition call quality for hands-free telephony. Media Interface allows connection and control of portable media devices (e.g. MP3 player, USB storage media) | ●                 | ●                   | ●                           |
| DAB digital radio tuner  | ●                 | ●                   | ●                           |
| Digital operating instructions   | ●                 | ●                   | ●                           |
| Head-up display<br>Virtual colour image (21×7 cm) showing information such as vehicle speed directly in driver's field of vision   | △                 | △                   | ●                           |

| Item  | Grand Edition (L) | Mercedes-AMG S 63 L | Mercedes-AMG S 63 L Premium |
|---|-------------------|---------------------|-----------------------------|
| Mercedes me connect (standard services)<br>Including emergency call system (eCall), accident recovery, breakdown management and maintenance management; Mercedes-Benz apps and in-car internet access for Facebook, internet radio, sending routes from Google Maps™ to the vehicle, news and weather reports; internet-enabled mobile phone required   | ●                 | ●                   | ●                           |
| Near Field Communication<br>Enables a convenient, wireless connection of the mobile phone with the vehicle's telematics simply by holding the mobile phone near the NFC logo on the head unit   | ●                 | ●                   | ●                           |
| Smartphone integration – comprising Apple CarPlay™<br>Compatible iPhones (iPhone 5 and newer) can be integrated into the vehicle via Apple CarPlay™. Please check on <a href="http://www.apple.com/uk/ios/carplay/">www.apple.com/uk/ios/carplay/</a> for compatibility and approved apps. Certain features and apps require a 3G or 4G data connection. Control of features available through voice control and controller on centre console | ●                 | ●                   | ●                           |
| Two USB ports in the rear   | ●                 | ●                   | ●                           |
| Wireless charging system (front) for mobile devices<br>Charges mobile phones which support the Qi standard wirelessly on a charging surface, Near Field Communication (NFC) for quickly connecting to mobile phone  | ●                 | ●                   | ●                           |





Book a [test drive](#)  
[AMG test drive](#)



[Find a Retailer](#)

# Wheels



**RRN** 20" AMG alloy wheels (4) – 10-spoke design painted high-gloss black  
 front: 245/40 tyres; rear: 275/35 tyres

|                             |   |
|-----------------------------|---|
| Grand Edition               | ● |
| Mercedes-AMG S 63 L         | - |
| Mercedes-AMG S 63 L Premium | - |



**647** 20" AMG alloy wheels (4) – 10-spoke design  
 front: 255/40 tyres; rear: 285/35 tyres

|                             |   |
|-----------------------------|---|
| Grand Edition               | - |
| Mercedes-AMG S 63 L         | ● |
| Mercedes-AMG S 63 L Premium | - |



**RTR** 20" AMG alloy wheels (4) – AMG cross-spoke forged wheels  
 front: 255/40 tyres; rear: 285/35 tyres

|                             |   |
|-----------------------------|---|
| Grand Edition               | - |
| Mercedes-AMG S 63 L         | - |
| Mercedes-AMG S 63 L Premium | ● |



**RTS** 20" AMG alloy wheels (4) – AMG cross-spoke forged wheels, matt black  
 front: 255/40 tyres; rear: 285/35 tyres

|                             |   |
|-----------------------------|---|
| Grand Edition               | - |
| Mercedes-AMG S 63 L         | △ |
| Mercedes-AMG S 63 L Premium | △ |



Book a  
 > test drive  
 > AMG test drive



> Find a Retailer

# AMG Night package



Options shown: Mercedes-AMG S63 Premium with cavansite blue paint (code 890)

More dramatic, more striking, more AMG: the AMG Night package includes the AMG front apron featuring an A-wing in high-gloss black. It also comes with the AMG sports exhaust system with two black chrome-finished twin tailpipe trim elements. The exterior mirror housings, AMG side sill panels and AMG rear apron are all finished in stylish high-gloss black. The AMG Night package is completed with 20" AMG cross-spoke forged alloy wheels painted matt black.

**AMG Night package** (code P60) – designed and priced as a package, including items as listed below.

|                                    |                                  |
|------------------------------------|----------------------------------|
| <b>Mercedes-AMG S 63 L</b>         | <b>Total incl. VAT £2,495.00</b> |
| <b>Mercedes-AMG S 63 L Premium</b> | <b>£1,495.00</b>                 |

---

20" AMG alloy wheels (4) – cross-spoke forged wheels, painted matt black (code RTS)

---

Air intake grilles in the front apron in high-gloss black

---

A-wing of AMG front apron in high-gloss black

---

AMG sports exhaust system with two black chrome-finished twin tailpipe trim elements

---

Exterior mirror housings, AMG side sill panels and AMG rear apron in high-gloss black

---



Book a [▶ test drive](#)  
[▶ AMG test drive](#)



[▶ Find a Retailer](#)

## Exclusive Nappa Leather package

The Exclusive nappa leather from *designo manufaktur* refines the entire interior, from the roof liner in DINAMICA microfibre through to the seats with diamond quilting and perforations, fully leather-finished doors, and dashboard in the finest designo Exclusive nappa leather.

**Exclusive Nappa Leather package** (code P34) – designed and priced as a package, including items listed.

### Grand Edition

**Total incl. VAT £5,595.00**

Only in conjunction with Executive equipment line (code DA1)

Please refer to page 50 for the full range of upholstery options

---

Exclusive Trim package (additional trim in door centre panels, covers of the rear air vents and on the backs of the front seats)

---

Grab handles and centre armrest at front and rear in nappa leather with contrasting topstitching

---

Map pockets on the backrests of the driver and front passenger seats in nappa leather

---

Roof liner and sun visors in DINAMICA microfibre

---

Seat upholstery layout with diamond design in Exclusive nappa leather with contrast topstitching

---

Stainless-steel boot sill

---

Upper section of instrument panel and door centre panels in nappa leather with contrast topstitching

---

Velour floor mats

---







Book a [▶ test drive](#)  
[▶ AMG test drive](#)



[▶ Find a Retailer](#)

# AMG Exclusive Nappa Leather package

**AMG Exclusive Nappa Leather package** (code P34) – designed and priced as a package, including items listed.

**Mercedes-AMG S 63 L**

**Total incl. VAT £5,595.00**

Please refer to page 51 for all upholstery options

---

Seat covers in AMG Exclusive nappa leather with contrast topstitching

---

Seat upholstery layout with AMG-specific diamond design AMG badges in front and rear seat backrests

---

Roof liner and sun visors in DINAMICA microfibre

---

Only in conjunction with either Executive equipment line (code DA1) or Individual Rear Seats package (code DA2)



Mercedes-AMG: Exclusive nappa leather in silk beige/espresso brown (code 565A)



Book a [test drive](#)  
[AMG test drive](#)



[Find a Retailer](#)

# Driving Assistance package

More comfort and less stress for the driver, and therefore more safety for all road users, for example by virtue of semi-automated driving, autonomous braking in certain dangerous situations and active assistance during evasive and braking manoeuvres initiated by the driver.

**Driving Assistance package** (code 23P) – including items listed below, designed and priced as a package. **Total incl. VAT £1,695.00**

Standard on Mercedes-AMG S 63L/Premium

---

**Active Distance Assist DISTRONIC** controls the distance to vehicles in front up to a speed of 131mph and if necessary brakes the vehicle with up to 50% of the maximum braking power

---

**Active Steering Assist** helps the driver keep the vehicle in the centre of its lane on straight stretches of road or slight bends. Reduces the risk of accidents and improves protection for both the occupants and other road users

---

**Active Speed Limit Assist** adopts speed limits detected automatically as the new set speed for Active Distance Assist DISTRONIC

---

**Active Braking Assist** with Cross-Traffic Function and Congestion emergency braking function can help to avoid or lessen the consequences of accidents with vehicles in front as well as crossing vehicles and pedestrians

---

**Evasive Steering Assist** is able to support the driver with making an evasive manoeuvre when, in a situation of danger, he/she decides to avoid a pedestrian who has been detected by the system

---

**Active Blind Spot Assist** can warn the driver of vehicles in the blind spot during a lane change and can help to avoid a collision by means of one-sided brake application

---

**Active Lane Keeping Assist** can warn the driver when they unintentionally leave their lane and can use one-sided brake applications to help manoeuvre the vehicle back into its lane (including in the case of broken lane markings if there is a risk of collision)

---

**PRE-SAFE® PLUS** is able to initiate preventive measures to protect occupants against an impending rear impact, including warning traffic following behind, activating the seat belt tensioners or applying the brakes when the vehicle is stationary

---

**Route-based speed adaptation** adjusts speed before curves, roundabouts, junctions, toll roads. Allows for smoother and more accurate functionality of several driving assistant systems

---

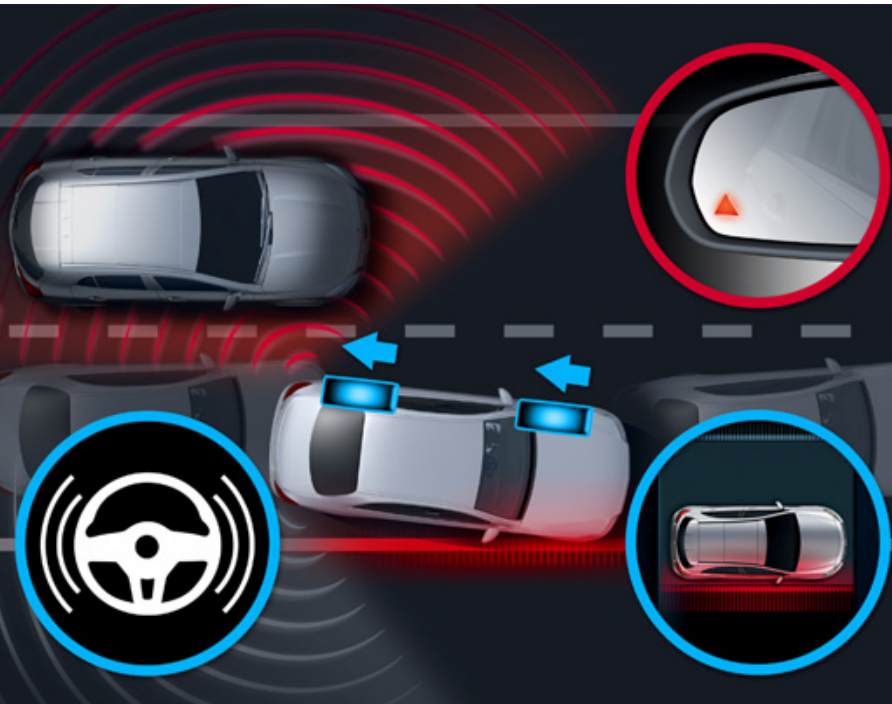

Active Lane Keeping Assist (blue) and Active Blind Spot Assist (red)



## Individual Rear Seats package



Mercedes-AMG models offer the option of two individual reclining rear seats in place of the standard three-person seat. At the touch of a button seats move into a comfortable reclining position, and luxury rear head restraints with an additional comfort cushion ensure the best possible comfort for the rear seats.

**Individual Rear Seats package** (code DA2) – designed and priced as a package, including items listed.

**Mercedes-AMG S 63 L/Premium**

**Total incl. VAT £6,995.00**

Not in conjunction with Executive equipment line (code DA1). Reduces boot capacity by 30 litres

---

Backrest angle adjustable up to 37°

---

Closing aid for doors and boot lid

---

Comfort-ventilated rear seats with cooling and heating functions

---

Electrically adjustable rear seats with memory function

---

Individual rear seats and folding rear tables

---

Luxury rear head restraints with additional comfort cushion

---

Roller Blind package with electrically operated blinds for rear and side windows

---

Stowage compartment with two 12 V sockets

---

Temperature-controlled cup holders (2)

---

THERMOTRONIC – luxury automatic climate control, rear

---





# Optional equipment

| Item   | Notes   | Grand Edition (L) | Mercedes-AMG S63 L | Mercedes-AMG S63 L Premium | Basic RRP<br>excl. VAT (£) | Total RRP<br>incl. VAT (£) |                 |
|--|---|-------------------|--------------------|----------------------------|----------------------------|----------------------------|-----------------|
| <b>AMG Performance Studio</b>  |   |                   |                    |                            |                            |                            |                 |
| <b>AMG Driver's package</b><br>Includes an increase to your vehicle's electronically limited top speed (186 mph) and participation in one of the AMG-PERFORMANCE Training 'Power and Passion' events. The event is run by the AMG Driving Academy and held at a racetrack located in mainland Europe               | For further information on this or any other AMG Driving Academy training, please speak to your Retailer, or visit <a href="http://www.mercedes-amg.com/driving-academy">www.mercedes-amg.com/driving-academy</a>   | 250               | -                  | ○                          | 2,295.83                   | <b>2,755.00</b>            |                 |
| <b>Comfort</b>   |   |                   |                    |                            |                            |                            |                 |
| <b>Winter package</b><br>Armrest heating in front, rear and centre console<br>Head-up display<br>Heated multifunction AMG Performance steering wheel (Mercedes-AMG Premium only)   |   | DP4               | ○                  | -                          | ●                          | 1,329.17                   | <b>1,595.00</b> |
| <b>Safety and Assistance Systems</b>   |   |                   |                    |                            |                            |                            |                 |
| <b>Rear Seat Safety package – for outer rear seats</b><br>Including rear sidebags and beltbags   | Only in conjunction with Executive equipment line (code DA1) or Individual Rear Seats package (code DA2)  | P36               | ○                  | ○                          | ○                          | 829.17                     | <b>995.00</b>   |
| <b>Service Package</b>   |   |                   |                    |                            |                            |                            |                 |
| <b>ServiceCare</b><br>ServiceCare allows you to spread the cost of servicing your new car in the Mercedes-Benz Retailer network. Taking out a ServiceCare plan ensures your servicing needs are taken care of by fully trained Mercedes-Benz Technicians with the added benefit of a Mercedes-Benz service history | Price is based on a monthly rate. Example given is for two services taken over 24 months; three services over 36 months; or four services over 48 months. Further payment options are available. New ServiceCare prices apply only to vehicles up to 12 months old prior to first service | 1                 | ○                  | -                          | -                          | 32.50                      | <b>39.00</b>    |
|  |   |                   | -                  | ○                          | ○                          | 36.67                      | <b>44.00</b>    |



Book a  
▶ test drive  
▶ AMG test drive



▶ Find a Retailer

## Genuine Accessories

We've developed a range of Accessories you can add to help personalise and enhance your S-Class. Your local Mercedes-Benz Retailer can advise on fitting costs of Accessories, where applicable. Further information on our full range of Genuine Accessories can be found **here** on the Mercedes-Benz Cars UK website.

### 01 | Velour floor mats CLASSIC, set, 4-piece (A22268060489F87)

Floor mats have to undergo rigorous testing before they are deemed worthy of the star logo: durability, fade-resistant colour and a neutral odour, even after three winters of use, are all specifications which must be met without compromise. The mats are precision-tailored to your Mercedes-Benz using the vehicle's original CAD data. Can be clip-fastened to the floor to prevent slipping.

**RRP £138.00 (incl. VAT)**

All the above accessories are subject to availability and compatibility. Please ask your Mercedes-Benz Retailer for more information

### 02 | Reversible mat (A2226800046)

100% polyester. Double-sided: rubberised, non-slip side and high-quality velour side. Design allows concertina load sill protector to be connected. Tailored to contours of load compartment. Helps protect load compartment floor from spillages and dirt. Easy to clean.

**RRP £129.60 (incl. VAT)**





Book a [test drive](#)  
[AMG test drive](#)



[Find a Retailer](#)

### 03 | Head restraint modular system

Carefree travel with Mercedes-Benz Style & Travel Equipment. The head restraint elements are simple to fit and remove. The modular system centres around a base support which can be combined with a coat hanger, universal hook, folding table and tablet mount.

Base support (A0008103300):

**RRP £23.50 (incl. VAT)**

Coat hanger (A0008103400):

**RRP £68.00 (incl. VAT)**

Folding table (A0008160000):

**RRP £108.00 (incl. VAT)**

Mount for tablet PC (A0008272200):

**RRP £124.80 (incl. VAT)**

Bag hook (A0008140000):

**RRP £28.00 (incl. VAT)**

Speak to your local Retailer for offers and discounts on these products.

All the above accessories are subject to availability and compatibility.  
Please ask your Mercedes-Benz Retailer for more information

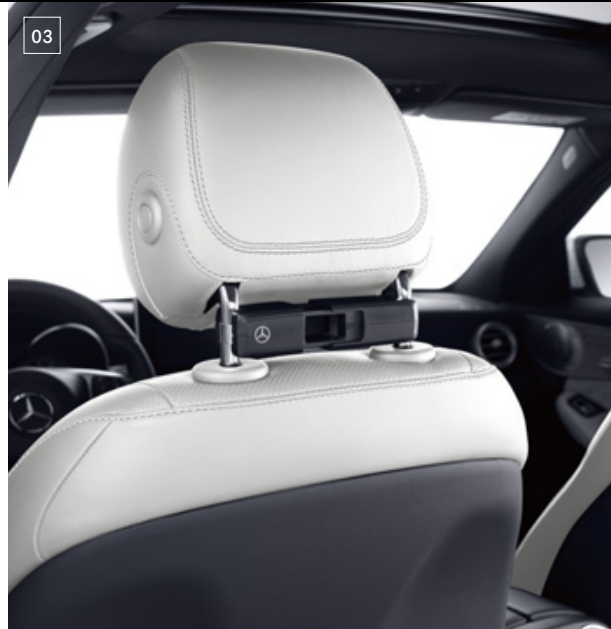





Book a [> test drive](#)  
[> AMG test drive](#)



[> Find a Retailer](#)

#### 04 | Flacon perfume atomiser<sup>1</sup> (part numbers will vary)

For vehicles with the AIR-BALANCE package. Flacons for perfume atomiser, 15 ml. Available in a variety of fragrances.

RRP from £56.00 (incl. VAT)

All the above accessories are subject to availability and compatibility. Please ask your Mercedes-Benz Retailer for more information

<sup>1</sup>Only available as part of the AIR-BALANCE package in conjunction with the Grand Edition model line and Mercedes-AMG models (please refer to page 29)

#### 05 | LED projectors, Mercedes star, two-piece (A2228200507)

Innovative LED projectors project a Mercedes star with a 3D effect onto the ground in the entrance area when opening the driver or front passenger door.

RRP £159.60 (incl. VAT) per pair, excluding fitting

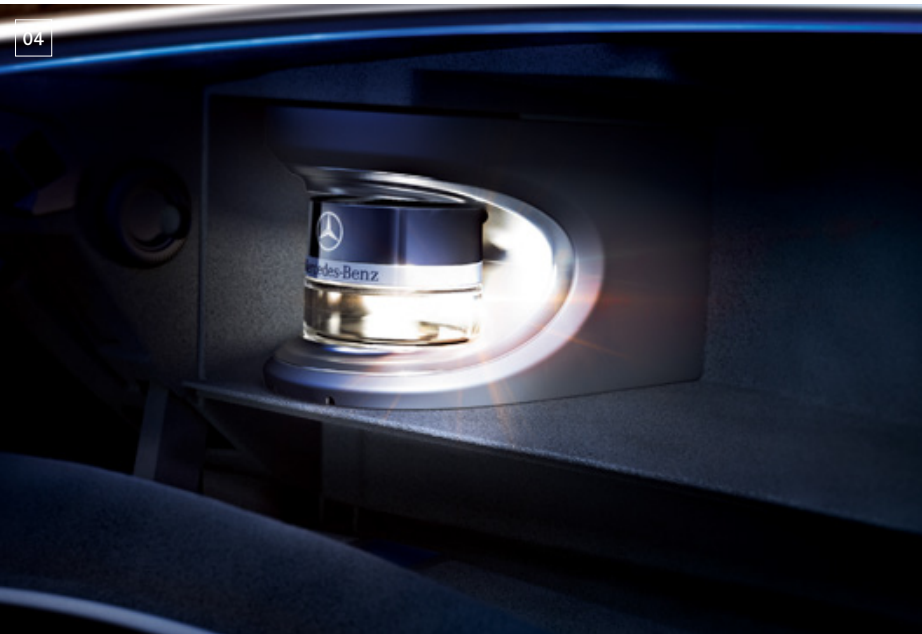



Book a [▶ test drive](#)  
[▶ AMG test drive](#)



[▶ Find a Retailer](#)

## Colours, trim and upholstery





Book a [▶ test drive](#)  
[▶ AMG test drive](#)



[▶ Find a Retailer](#)

# Metallic paints (standard)

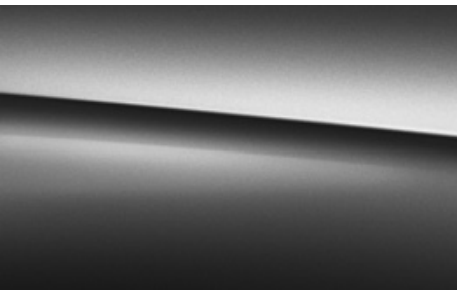

183U magnetite black

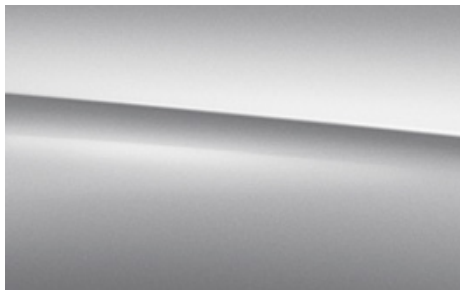

775U iridium silver

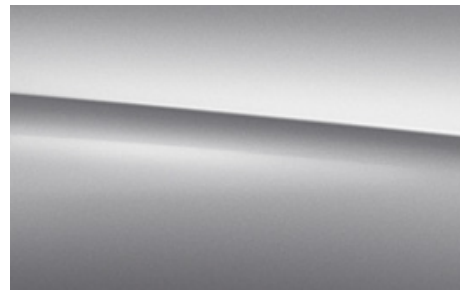

988U diamond silver



998U anthracite blue

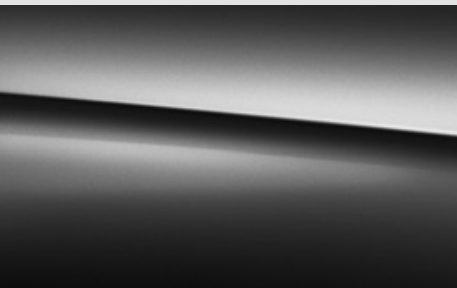

197U obsidian black

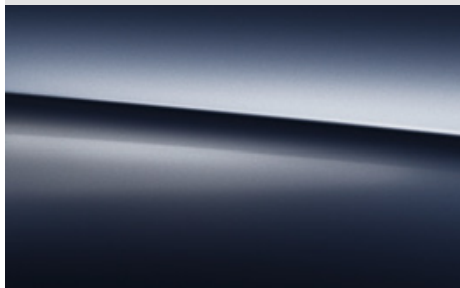

890U cavansite blue

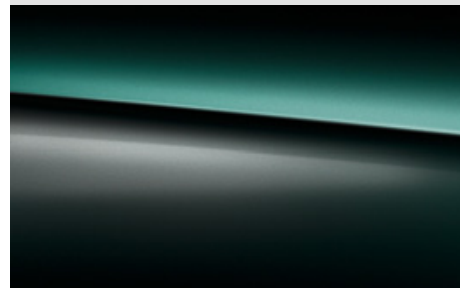

989U emerald green

## Special metallic paint (additional-cost option)

An extra degree of exclusivity is guaranteed with a designo paint finish, available at additional cost.



296U aragonite silver

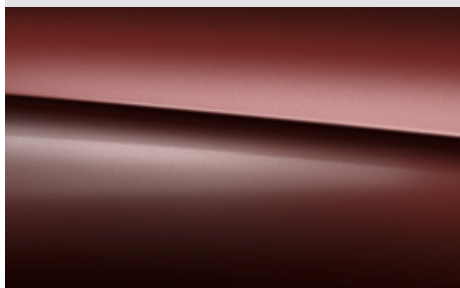

897U ruby black

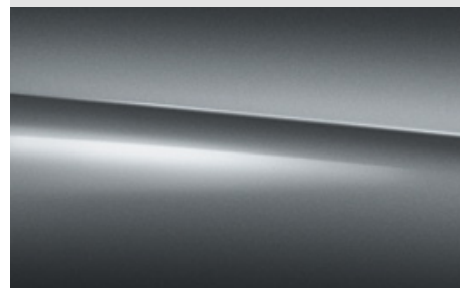

992U selenite grey



799 designo diamond white **£760.00 incl. VAT**



Book a [▶ test drive](#)  
[▶ AMG test drive](#)



[▶ Find a Retailer](#)

# Trim



H27 designo open-pore black ash wood

|                                |               |
|--------------------------------|---------------|
| Grand Edition                  | ●             |
| Mercedes-AMG S 63 L            | ○             |
| Mercedes-AMG S 63 L Premium    | ○             |
| <b>Basic RRP incl. VAT (£)</b> | <b>495.00</b> |
| excl. VAT (£)                  | 412.50        |



729 black poplar wood

|                                |                       |
|--------------------------------|-----------------------|
| Grand Edition                  | -                     |
| Mercedes-AMG S 63 L            | ●                     |
| Mercedes-AMG S 63 L Premium    | ●                     |
| <b>Basic RRP incl. VAT (£)</b> | <b>no-cost option</b> |
| excl. VAT (£)                  | -                     |



H29 brown burr walnut wood

|                                |                       |
|--------------------------------|-----------------------|
| Grand Edition                  | -                     |
| Mercedes-AMG S 63 L            | ○                     |
| Mercedes-AMG S 63 L Premium    | ○                     |
| <b>Basic RRP incl. VAT (£)</b> | <b>no-cost option</b> |
| excl. VAT (£)                  | -                     |





H21 designo black piano lacquer

|                             |   |
|-----------------------------|---|
| Grand Edition               | - |
| Mercedes-AMG S 63 L         | ○ |
| Mercedes-AMG S 63 L Premium | ○ |

|                                |               |
|--------------------------------|---------------|
| <b>Basic RRP incl. VAT (£)</b> | <b>495.00</b> |
| excl. VAT (£)                  | 412.50        |

Only in conjunction with Exclusive Nappa Leather package (code P34)



H10 AMG carbon fibre/black piano lacquer

|                             |   |
|-----------------------------|---|
| Grand Edition               | - |
| Mercedes-AMG S 63 L         | ○ |
| Mercedes-AMG S 63 L Premium | ○ |

|                                |                 |
|--------------------------------|-----------------|
| <b>Basic RRP incl. VAT (£)</b> | <b>2,895.00</b> |
| excl. VAT (£)                  | 2,412.50        |

Only in conjunction with Exclusive Nappa Leather package (code P34)



Book a [▶ test drive](#)  
[▶ AMG test drive](#)



[▶ Find a Retailer](#)

# Nappa leather<sup>1</sup> (standard on Grand Edition)



801A black



814A nut brown/black



818A magma grey/espresso brown



805A silk beige/espresso brown



815A porcelain/black

<sup>1</sup>100% of seat upholstery is pure leather



Book a [▶ test drive](#)  
[▶ AMG test drive](#)



[▶ Find a Retailer](#)

# Nappa leather<sup>1</sup> (standard on Mercedes-AMG S 63 L/Premium)



851A black



864A nut brown/black



868A magma grey/espresso brown



855A silk beige/espresso brown



865A porcelain/black

<sup>1</sup>100% of seat upholstery is pure leather





Book a [▶ test drive](#)  
[▶ AMG test drive](#)



[▶ Find a Retailer](#)

# Exclusive nappa leather<sup>1</sup> (optional on Grand Edition)

Total incl. VAT £5,595.00



501A black



514A nut brown/black



518A magma grey/espresso brown



505A silk beige/espresso brown



515A porcelain/black



524A mahogany brown/silk beige

<sup>1</sup>100% of seat upholstery is pure leather





Book a [▶ test drive](#)  
[▶ AMG test drive](#)



[▶ Find a Retailer](#)

# Exclusive nappa leather<sup>1</sup> (opt. on Mercedes-AMG S 63 L/Premium)

Total incl. VAT £5,595.00



561A black



584A nut brown/black



588A magma grey/espresso brown



565A silk beige/espresso brown



585A porcelain/black



564A mahogany brown/silk beige

<sup>1</sup>Included with Exclusive Nappa Leather package (code P34)



# Trim and upholstery combinations

|                             | Nappa leather <sup>1</sup> /Exclusive nappa leather <sup>1</sup> |  |  |  |  | Exclusive nappa leather <sup>1</sup>         |
|-----------------------------|--|--|--|--|--|--|
|                             | black<br>(801A/851A/501A/561A)                                   | silk beige/espresso brown<br>(805A/855A/505A/565A) | nut brown/black<br>(814A/864A/514A/584A) | porcelain/black<br>(815A/865A/515A/585A) | magma grey/<br>espresso brown<br>(818A/868A/518A/588A) | mahogany brown/<br>silk beige<br>(524A/564A) |
| <b>Dashboard</b>            |  |  |  |  |  |  |
| Steering wheel              | black  | silk beige   | black                                    | black                                    | black  | silk beige                                   |
| Upper dashboard trim        | black  | espresso brown                                     | black                                    | black                                    | espresso brown   | mahogany brown                               |
| Centre dashboard trim       | black  | silk beige   | nut brown                                | porcelain                                | magma grey   | silk beige                                   |
| Lower dashboard trim        | black  | silk beige   | black                                    | black                                    | black  | silk beige                                   |
| <b>Seats</b>                |  |  |  |  |  |  |
| Seat cushion centre section | black  | silk beige   | nut brown                                | porcelain                                | magma grey   | mahogany brown                               |
| Side bolster trim           | black  | silk beige   | nut brown                                | porcelain                                | magma grey   | mahogany brown                               |
| Head restraint              | black  | silk beige   | nut brown                                | porcelain                                | magma grey   | mahogany brown                               |
| Contrast stitching          | black  | silk beige/espresso brown                          | nut brown/black                          | porcelain/black                          | espresso brown   | mahogany brown                               |
| Seat belt                   | black  | silk beige   | nut brown                                | black                                    | magma grey   | silk beige                                   |
| <b>Doors</b>                |  |  |  |  |  |  |
| Door trim at beltline       | black  | espresso brown                                     | black                                    | black                                    | espresso brown   | mahogany brown                               |
| Door centre panel           | black  | silk beige   | nut brown                                | porcelain                                | magma grey   | silk beige                                   |
| Lower door trim             | black  | silk beige   | black                                    | black                                    | magma grey   | silk beige                                   |
| <b>Roof lining</b>          | black  | porcelain  | black                                    | black                                    | crystal grey   | porcelain                                    |
| <b>Parcel shelf</b>         | black  | espresso brown                                     | black                                    | black                                    | espresso brown   | mahogany brown                               |
| <b>Floor covering</b>       |  |  |  |  |  |  |
| Front and rear              | black  | silk beige   | black                                    | black                                    | grey   | silk beige                                   |
| Boot                        | black  | black  | black                                    | black                                    | black  | black  |

<sup>1</sup>100% of seat upholstery is pure leather



# Technical data

|  |                | Diesel engines        |                       |                       |
|--|----------------|-----------------------|-----------------------|-----------------------|
| Model  |                | S 350 d               | S 350 d L             | S 400 d L             |
| <b>Engine</b>  |                |                       |                       |                       |
| Total displacement                                       | cc             | 2,925                 | 2,925                 | 2,925                 |
| Arrangement/cylinders/valves                             |                | in-line/6/24          | in-line/6/24          | in-line/6/24          |
| Power <sup>1</sup>                                       | hp (kW) at rpm | 286 (210)/3,400-4,600 | 286 (210)/3,400-4,600 | 340 (250)/3,600-4,400 |
| Torque <sup>1</sup>                                      | Nm at rpm      | 600/1,200-3,200       | 600/1,200-3,200       | 700/1,200-3,200       |
| Compression ratio  |                | 15.5:1                | 15.5:1                | 15.5:1                |
| Emissions standard                                       |                | Euro 6d-TEMP-EVAP-ISC | Euro 6d-TEMP-EVAP-ISC | Euro 6d-TEMP-EVAP-ISC |
| <b>Transmission</b>                                      |                |                       |                       |                       |
| 9G-TRONIC PLUS 9-speed automatic                         |                | ●                     | ●                     | ●                     |
| AMG SPEEDSHIFT MCT 9-speed automatic sports transmission |                | -                     | -                     | -                     |
| <b>Performance</b>                                       |                |                       |                       |                       |
| Acceleration 0-62 mph                                    | sec            | 6.0                   | 6.0                   | 5.4                   |
| Top speed  | mph            | 155 <sup>2</sup>      | 155 <sup>2</sup>      | 155 <sup>2</sup>      |



| Model | Diesel engines |           |           |
|-------|----------------|-----------|-----------|
|       | S 350 d        | S 350 d L | S 400 d L |

**Weights and capacities**

|                                     |    |           |           |       |
|-------------------------------------|----|-----------|-----------|-------|
| Kerb weight <sup>3</sup>            | kg | 2,000     | 2,020     | 2,055 |
| Perm. Gross Vehicle Weight          | kg | 2,700     | 2,720     | 2,740 |
| Boot capacity                       | l  | 510       | 510       | 510   |
| Fuel tank capacity/of which reserve | l  | 70/8      | 70/8      | 70/8  |
| Turning circle                      | m  | 11.9/12.3 | 11.9/12.3 | 12.3  |

**Fuel consumption<sup>4,5,6</sup>**

|   |                |                      |                      |                      |
|---|----------------|----------------------|----------------------|----------------------|
| Combined (consumption dependent on chosen optional equipment) | l/100km<br>mpg | 7.2-6.4<br>39.2-44.1 | 7.3-6.4<br>38.7-44.1 | 7.2-6.4<br>39.2-44.1 |
|---|----------------|----------------------|----------------------|----------------------|

**Insurance**

|                                |     |     |     |
|--------------------------------|-----|-----|-----|
| Group rating                   | 47E | 47E | 50E |
| Incl. Executive equipment line | 49E | 49E | 50E |

Insurance ratings may vary depending on model line and specification. Please refer to <http://www.thatcham.org/abigrouprating/> for further details

<sup>3</sup>Mass of the vehicle in running order with at least 90% full fuel tank, plus the mass of the driver (estimated by law at 75 kg), fuel and fluids, equipped with the standard equipment as specified by the manufacturer as well as, where applicable, the mass of the body, cab, trailer coupling and spare wheel(s) as well as tools. Optional extras, additional equipment and accessories can influence the weight, residual payload, rolling resistance, aerodynamics, etc., and therefore also affect the consumption/CO<sub>2</sub> values

<sup>4</sup>All figures are based on a standard specification with the smallest tyre size <sup>5</sup>The choice of wheels and transmission may affect CO<sub>2</sub> emissions and corresponding Road Fund Licence

<sup>6</sup>The indicated values were determined according to the prescribed measurement method - Worldwide Harmonised Light Vehicle Test Procedure (WLTP). Figures shown may include options which are not available in the UK

Figures shown are for comparability purposes; only compare with other cars tested to the same technical procedures. Figures may not reflect real life driving results, which will depend upon a number of factors including the starting charge of the battery, factory-fitted options, accessories fitted (post registration), variations in weather, driving styles and vehicle load. Further information about the test used to establish fuel consumption and CO<sub>2</sub> figures can be found at <http://www.mercedes-benz.co.uk/WLTP>





|  |                | Petrol engines        |                       |                       |                       |
|--|----------------|-----------------------|-----------------------|-----------------------|-----------------------|
| Model  |                | S 450 L               | S 500 L               | S 560 e L             | Mercedes-AMG S 63 L   |
| <b>Engine</b>  |                |                       |                       |                       |                       |
| Total displacement                                       | cc             | 2,999                 | 2,999                 | 2,996                 | 3,982                 |
| Arrangement/cylinders/valves                             |                | in-line/6/24          | in-line/6/24          | V/6/24                | V/8/32                |
| Power <sup>1</sup>                                       | hp (kW) at rpm |                       |                       |                       |                       |
| Combustion engine  |                | 367 (270)/5,500–6,100 | 435 (320)/5,900–6,100 | 367 (270)/5,500–6,000 | 612 (450)/5,500–6,000 |
| EQ Boost/EQ Power (S 560 e L)                            |                | 22 (16)/900           | 22 (16)/900           | 122 (90)/-            | -                     |
| Torque <sup>1</sup>                                      | Nm at rpm      |                       |                       |                       |                       |
| Combustion engine  |                | 500/1,600–4,000       | 520/1,800–5,500       | 500/1,800–4,500       | 900/2,750–4,500       |
| EQ Boost/EQ Power (S 560 e L)                            |                | 250                   | 250                   | 440                   | -                     |
| Compression ratio  |                | 10.5:1                | 10.5:1                | 10.5:1                | 8.6:1                 |
| Equivalent All-Electric Range (EAER) <sup>2</sup>        | mi             | -                     | -                     | 26.1–27.3             | -                     |
| Power consumption, combined <sup>2</sup>                 | Wh/km          | -                     | -                     | 254–268               | -                     |
| Capacity on-board charger                                | kW             | -                     | -                     | 7.2                   | -                     |
| Emissions standard                                       |                | Euro 6d-TEMP-EVAP-ISC | Euro 6d-TEMP-EVAP-ISC | Euro 6d-TEMP-EVAP-ISC | Euro 6d-TEMP-EVAP-ISC |
| <b>Transmission</b>                                      |                |                       |                       |                       |                       |
| 9G-TRONIC PLUS 9-speed automatic                         |                | ●                     | ●                     | ●                     | -                     |
| AMG SPEEDSHIFT MCT 9-speed automatic sports transmission |                | -                     | -                     | -                     | ●                     |

● Standard ○ Optional - Not available <sup>1</sup>Figures according to Directive 80/1269/EEC in the currently applicable version

<sup>2</sup>The indicated values were determined according to the prescribed measurement method – Worldwide Harmonised Light Vehicle Test Procedure (WLTP). Figures shown may include options which are not available in the UK.

For Plug-in Hybrid Electric Vehicle (PHEV) figures determined with the battery fully charged, using a combination of both battery power and fuel. These models require mains electricity for charging



| Model | Petrol engines |         |           |                     |
|-------|----------------|---------|-----------|---------------------|
|       | S 450 L        | S 500 L | S 560 e L | Mercedes-AMG S 63 L |

**Performance**

|                       |     |                  |                  |                  |                  |
|-----------------------|-----|------------------|------------------|------------------|------------------|
| Acceleration 0-62 mph | sec | 5.1              | 4.8              | 5.0              | 4.3              |
| Top speed             | mph | 155 <sup>3</sup> | 155 <sup>3</sup> | 155 <sup>3</sup> | 155 <sup>3</sup> |

**Weights and capacities**

|                                     |    |       |       |       |       |
|-------------------------------------|----|-------|-------|-------|-------|
| Kerb weight <sup>4</sup>            | kg | 2,015 | 2,030 | 2,225 | 2,045 |
| Perm. Gross Vehicle Weight          | kg | 2,700 | 2,695 | 2,825 | 2,715 |
| Boot capacity                       | l  | 530   | 530   | 395   | 510   |
| Fuel tank capacity/of which reserve | l  | 70/8  | 70/8  | 70/8  | 70/10 |
| Turning circle                      | m  | 12.3  | 12.3  | 12.3  | 12.34 |

<sup>3</sup>Electronically limited

<sup>4</sup>Mass of the vehicle in running order with at least 90% full fuel tank, plus the mass of the driver (estimated by law at 75 kg), fuel and fluids, equipped with the standard equipment as specified by the manufacturer as well as, where applicable, the mass of the body, cab, trailer coupling and spare wheel(s) as well as tools. Optional extras, additional equipment and accessories can influence the weight, residual payload, rolling resistance, aerodynamics, etc., and therefore also affect the consumption/CO<sub>2</sub> values



| Model | Petrol engines |         |           |                     |
|-------|----------------|---------|-----------|---------------------|
|       | S 450 L        | S 500 L | S 560 e L | Mercedes-AMG S 63 L |

**Fuel consumption<sup>5,6,7</sup>**

| Combined (consumption dependent on chosen optional equipment) | l/100 km | mpg       | l/100 km | mpg       | l/100 km | mpg         | l/100 km  | mpg       |
|---|----------|-----------|----------|-----------|----------|-------------|-----------|-----------|
|   | 8.5-7.8  | 33.2-36.2 | 8.5-7.8  | 33.2-36.2 | 2.7-2.2  | 104.6-128.4 | 12.2-11.6 | 23.2-24.4 |

**Insurance**

|                                |     |     |     |     |
|--------------------------------|-----|-----|-----|-----|
| Group rating                   | 49E | 50E | 50E | 50E |
| Incl. Executive equipment line | 50E | 50E | 50E | 50E |

Insurance ratings may vary depending on model line and specification. Please refer to <http://www.thatcham.org/abigrouprating/> for further details

<sup>5</sup>All figures are based on a standard specification with the smallest tyre size <sup>6</sup>The choice of wheels and transmission may affect CO<sub>2</sub> emissions and corresponding Road Fund Licence

<sup>7</sup>The indicated values were determined according to the prescribed measurement method - Worldwide Harmonised Light Vehicle Test Procedure (WLTP). Figures shown may include options which are not available in the UK.

For Plug-in Hybrid Electric Vehicle (PHEV) figures determined with the battery fully charged, using a combination of both battery power and fuel. These models require mains electricity for charging

Figures shown are for comparability purposes; only compare with other cars tested to the same technical procedures. Figures may not reflect real life driving results, which will depend upon a number of factors including the starting charge of the battery, factory-fitted options, accessories fitted (post registration), variations in weather, driving styles and vehicle load. Further information about the test used to establish fuel consumption and CO<sub>2</sub> figures can be found at <http://www.mercedes-benz.co.uk/WLTP>



Book a [test drive](#)  
[AMG test drive](#)



[Find a Retailer](#)

## S-Class

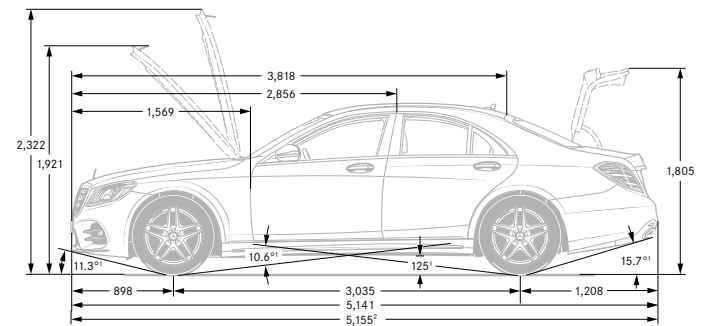
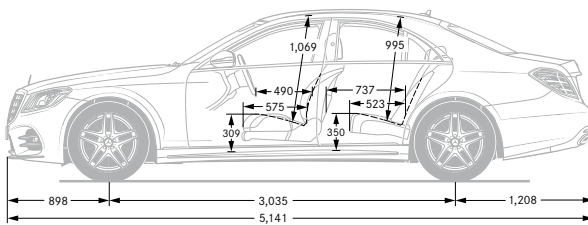
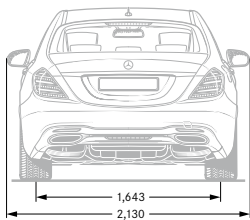
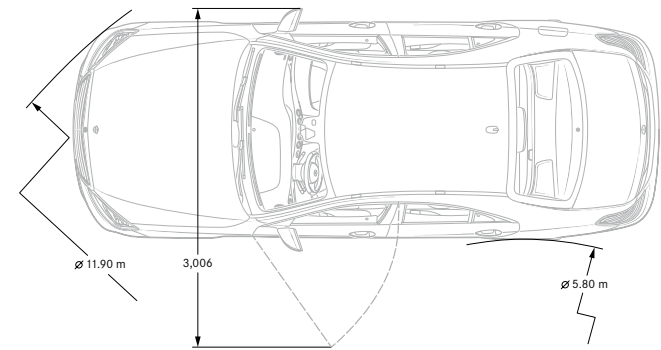
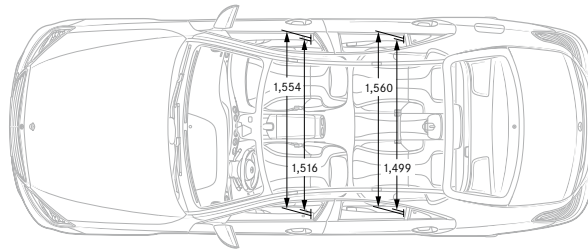
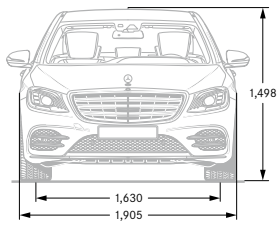

All measurements in millimetres. The dimensions shown are mean values and apply to standard-specification, unladen vehicles.





Book a [test drive](#)  
[AMG test drive](#)



[Find a Retailer](#)

## S-Class L

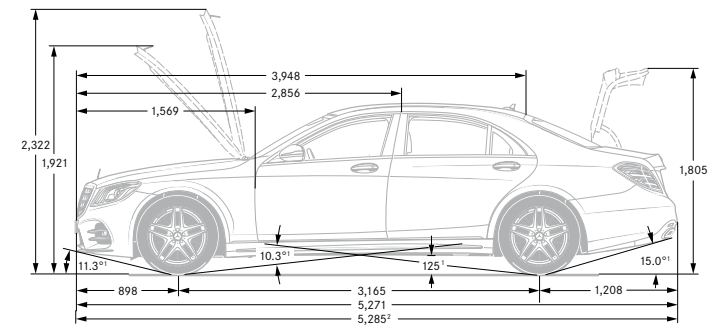
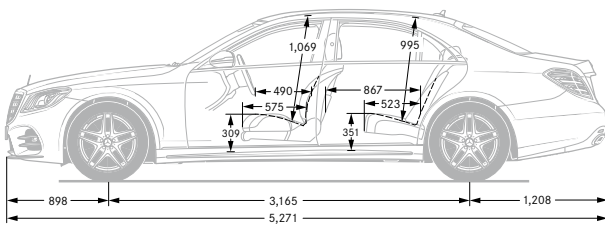
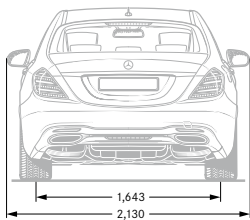
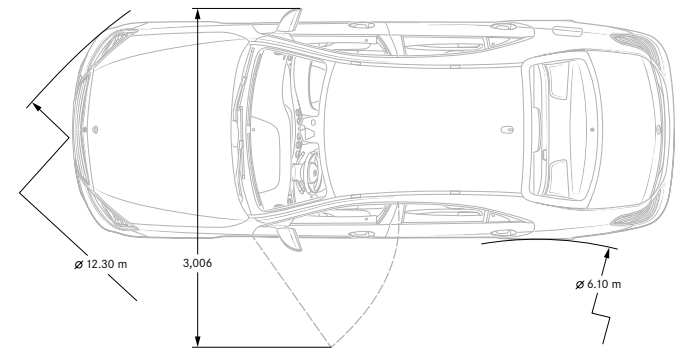
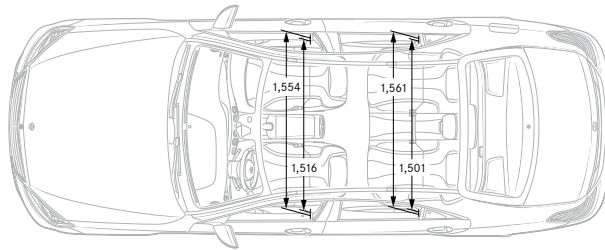
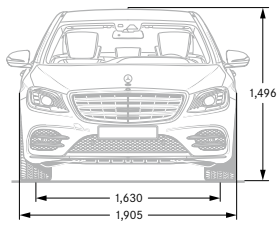

All measurements in millimetres. The dimensions shown are mean values and apply to standard-specification, unladen vehicles



Book a [test drive](#)  
[AMG test drive](#)



[Find a Retailer](#)

## Mercedes-AMG S 63 L

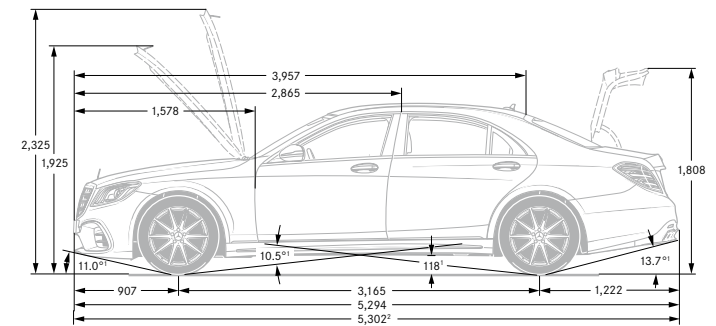
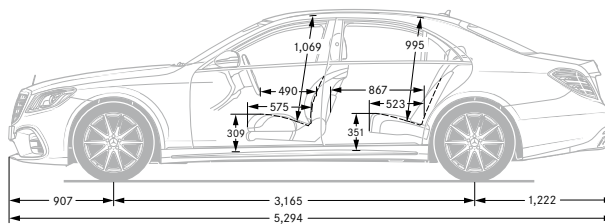
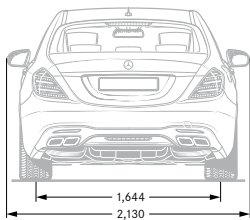
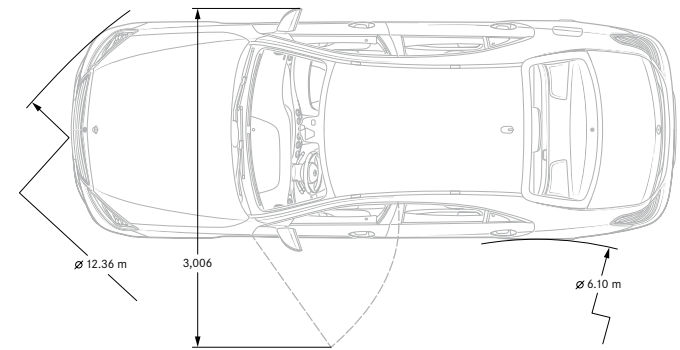
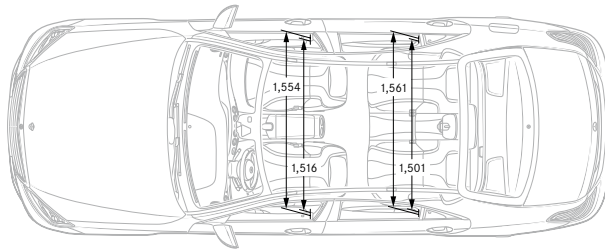
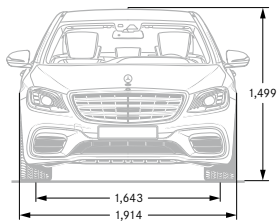

All measurements in millimetres. The dimensions shown are mean values and apply to standard-specification, unladen vehicles.  
 The figures on pages 53–60 are correct at time of publication



# Road Fund Licence



All road vehicle registrations are subject to Vehicle Excise Duty (Road Fund Licence), which varies in accordance with the vehicle's CO<sub>2</sub> emissions. A first year rate for each taxation band will apply. The table below shows the bands (A–M) created by the DVLA and the corresponding Road Fund Licence. CO<sub>2</sub> emissions and the relevant Excise Duty are shown on the model pricing page 8.

| Band | CO <sub>2</sub> emissions (g/km) | First year rate petrol and RDE2 diesel (£) | First year rate all other diesel (£) <sup>1</sup> | First year rate alternative fuel (£) | Electric vehicles |                               | Alternative fuel vehicles |                               | Petrol/diesel vehicles |                               |
|------|----------------------------------|--|---|--------------------------------------|-------------------|-------------------------------|---------------------------|-------------------------------|------------------------|-------------------------------|
|      |                                  |  |   |                                      | Standard rate (£) | Premium rate (£) <sup>2</sup> | Standard rate (£)         | Premium rate (£) <sup>2</sup> | Standard rate (£)      | Premium rate (£) <sup>2</sup> |
| A    | 0                                | 0.00                                       | 0.00  | 0.00                                 | 0.00              | 0.00                          | 0.00                      | 0.00                          | 0.00                   | 0.00                          |
| B    | 1 to 50                          | 10.00                                      | 25.00   | 0.00                                 | 0.00              | 0.00                          | 145.00                    | 465.00                        | 150.00                 | 475.00                        |
| C    | 51 to 75                         | 25.00                                      | 110.00  | 15.00                                | 0.00              | 0.00                          | 145.00                    | 465.00                        | 150.00                 | 475.00                        |
| D    | 76 to 90                         | 110.00                                     | 135.00  | 100.00                               | 0.00              | 0.00                          | 145.00                    | 465.00                        | 150.00                 | 475.00                        |
| E    | 91 to 100                        | 135.00                                     | 155.00  | 125.00                               | 0.00              | 0.00                          | 145.00                    | 465.00                        | 150.00                 | 475.00                        |
| F    | 101 to 110                       | 155.00                                     | 175.00  | 145.00                               | 0.00              | 0.00                          | 145.00                    | 465.00                        | 150.00                 | 475.00                        |
| G    | 111 to 130                       | 175.00                                     | 215.00  | 165.00                               | 0.00              | 0.00                          | 145.00                    | 465.00                        | 150.00                 | 475.00                        |
| H    | 131 to 150                       | 215.00                                     | 540.00  | 205.00                               | 0.00              | 0.00                          | 145.00                    | 465.00                        | 150.00                 | 475.00                        |
| I    | 151 to 170                       | 540.00                                     | 870.00  | 530.00                               | 0.00              | 0.00                          | 145.00                    | 465.00                        | 150.00                 | 475.00                        |
| J    | 171 to 190                       | 870.00                                     | 1,305.00  | 860.00                               | 0.00              | 0.00                          | 145.00                    | 465.00                        | 150.00                 | 475.00                        |
| K    | 191 to 225                       | 1,305.00                                   | 1,850.00  | 1,295.00                             | 0.00              | 0.00                          | 145.00                    | 465.00                        | 150.00                 | 475.00                        |
| L    | 226 to 255                       | 1,850.00                                   | 2,175.00  | 1,840.00                             | 0.00              | 0.00                          | 145.00                    | 465.00                        | 150.00                 | 475.00                        |
| M    | over 255                         | 2,175.00                                   | 2,175.00  | 2,165.00                             | 0.00              | 0.00                          | 145.00                    | 465.00                        | 150.00                 | 475.00                        |

<sup>1</sup>Alternative fuel vehicles receive a £10 reduction on vehicle tax rates

<sup>2</sup>Applies to all Mercedes-Benz diesel models which do not comply with Real Driving Emissions step 2 (RDE2)

<sup>3</sup>Premium rate only applicable to vehicles where the list price is over £40,000 including any factory-fitted options, standard UK delivery charge, number plates, fuel and VAT



Book a [▶ test drive](#)  
[▶ AMG test drive](#)



[▶ Find a Retailer](#)

# Services and insurance

## Mercedes-Benz ServiceCare

We believe that servicing costs should be as flexible and affordable as possible for your S-Class, which is why we offer ServiceCare, an easy way to budget for all your servicing costs. It spreads your bills into manageable payments based on whether you have a new or used Mercedes-Benz.

With ServiceCare we guarantee the price of parts and labour for up to four services and safeguard against any further inflation. It also covers the cost of all recommended service items including brake fluid, spark plugs, air filters, fuel filters and screen wash.

You can choose either to add your servicing costs into your monthly spend or pay the full amount in a one-off payment, giving you peace of mind that they are taken care of for the period of the plan.

To receive a personalised ServiceCare plan recommendation visit the ServiceCare Calculator at [servicecarerates.mercedes-benz.co.uk](http://servicecarerates.mercedes-benz.co.uk)

## Warranty and breakdown cover

Every Mercedes-Benz comes with a three-year unlimited mileage warranty against manufacturing or material defects<sup>1</sup> and up to 30 years warranty against perforation due to corrosion from the inside out.<sup>2</sup> What's more, it's also covered by Mercedes-Benz Roadside Assistance – a unique package comprising up to 30 years pan-European breakdown assistance.<sup>2</sup>

## Motor Insurance

Superb cover comes as standard. When reviewed by an independent research company, Defaqto, Mercedes-Benz Motor Insurance received a five-star rating, the highest rating available. We design our Motor Insurance specifically for Mercedes-Benz drivers.

For more information or to obtain a quote, click [here](#).





Book a  
 > test drive  
 > AMG test drive



> Find a Retailer

# Mercedes me connect.

Stay connected, any time, anywhere.

Mercedes me is a range of innovative online services designed to enhance your Mercedes-Benz experience. Accessible via mobile, tablet or PC, Mercedes me lets you enjoy the highest standards of care and support, in a way that integrates seamlessly with your busy lifestyle.



## Navigation Services (0 1U)

Visit the Mercedes me connect store or app for pricing.



**Live Traffic Information<sup>1</sup>**  
 Your navigation system receives traffic data in real time, enabling it to optimise the dynamic route guidance, minimising drive time and offering more precise estimation of arrival times.



**Available parking spaces**  
 Locates parking spaces for you in multi-storey car parks and on the street. Saving you time and hassle.

## Infotainment

Visit the Mercedes me connect store or app for pricing.



**connect Store**  
 In the Mercedes me connect Store you can purchase many digital services designed to make your everyday life easier and provide useful information relating to your networked vehicle.



**TIDAL**  
 Love music? Get a 3-month TIDAL HiFi subscription free with Mercedes me connect (worth £60) and unlock access to 58 million songs.



**Local Search**  
 This feature provides support in the local search for restaurants or hotels and much more.



**Send2Car**  
 Make your journey easier: set your destination using the Mercedes me app and send it directly to your car's navigation system.



**Internet Radio**  
 Listen to podcasts and radio stations from anywhere in the world.



**Digital Assistant**  
 Digital Assistant allows you to connect to your car via Amazon Alexa or Google Assistant, meaning you can ask from the comfort of your sofa - is my car locked? When's the next service due? How much fuel do I have? Plus much more.

For more information speak to your local Retailer or visit the Mercedes me connect store at [shop.mercedes-benz.com/en-gb/connect](http://shop.mercedes-benz.com/en-gb/connect)

<sup>1</sup>Free of charge for first 3 years. Extension possible, visit the Mercedes me connect store for details on pricing



Book a  
 > test drive  
 > AMG test drive



> Find a Retailer

# Mercedes me connect.

Stay connected, any time, anywhere.

Mercedes me is a range of innovative online services designed to enhance your Mercedes-Benz experience. Accessible via mobile, tablet or PC, Mercedes me lets you enjoy the highest standards of care and support, in a way that integrates seamlessly with your busy lifestyle.



## Vehicle Set-up (08U)

Visit the Mercedes me connect store or app for pricing.



**Remote Vehicle Status**

Check safety information, such as coolant level and brake pad condition, so you can be sure your car is safe and ready to drive.



**Personalisation**

Store your preferences, such as your favourite radio stations and apps, to create your personal driver profile.

## Vehicle Monitoring (09U)

Visit the Mercedes me connect store or app for pricing.



**Parked Vehicle Locator**

Forgot where you parked your car? No problem: you can locate and track your car, with the Parked Vehicle Locator.



**Vehicle Tracker**

Track the location of your car anywhere in the world.



**Pre-Entry Climate Control**

Programming of charging settings and Pre-Entry Climate Control for plug-in vehicles.



**Remote Door Locking/Unlocking**

Lock and unlock your car remotely, wherever you are in the world.



**ECO Display**

Monitor your driving style with ECO Display. It summarises your driving style from the start of the journey to its completion to help you achieve the most economical way to drive.

|  |  |
|--|--|
| Average acceleration<br>1.5 ms <sup>-2</sup>     | Average deceleration<br>3.9 ms <sup>-2</sup> |
| Consumption 19.2 mpg<br>Distance travelled 54 mi | Sliding 0%<br>Coasting 67%<br>Braking 1.5%   |



**Geo-fencing**

Set up a geographical boundary and receive alerts whenever your car enters or leaves this area.

For more information speak to your local Retailer or visit the Mercedes me connect store at [shop.mercedes-benz.com/en-gb/connect](http://shop.mercedes-benz.com/en-gb/connect)



# Mercedes-Benz Finance

## Why should you finance with Mercedes-Benz?

At Mercedes-Benz we believe a great driving experience should be matched by an equally great ownership experience. That is why we put just as much thought, time and effort into designing our finance options, our service plans and our insurance cover as we do into our vehicles.

We are not in the business of simply providing a loan to fund the purchase of your dream vehicle. We look on it as a journey that we take with you, from the moment you choose your new Mercedes-Benz, to helping you in choosing your next one.

If you would like to find out more about any of our current offers, simply call into your local Mercedes-Benz Retailer where one of our Business Managers will be more than happy to talk you through anything you need to know.

## Helping you find the right solution.

You should find our finance packages are more convenient than a traditional personal loan because:

- Funds are immediately available – no waiting for cheques or loans to clear.
- There is no security required – either against your home or other assets.
- We have clear and transparent rates – the APR we quote is the APR you get.
- We have friendly Business Managers – experts in vehicle finance who can talk you through all of your plans in detail.

One of our most popular finance products is Mercedes-Benz Agility (our Personal Contract Purchase product). We also offer Contract Hire, Operating Lease and Hire Purchase solutions. If you would like to find out more about these speak to your Retailer or visit [www.mercedes-benz.co.uk/fandi](http://www.mercedes-benz.co.uk/fandi).

## Mercedes-Benz Agility (our PCP product).

At the start of an Agility agreement, you put down a deposit and decide the term of your agreement and your annual mileage. You will be advised of the Guaranteed Future Value, which offers you the reassurance of knowing exactly what you will need to pay to own the vehicle outright in the future (this is known as the Optional Purchase Payment).

Throughout your agreement you simply pay your agreed monthly payments and when the agreement comes to an end you either purchase, hand back or part-exchange your vehicle.







### Agility features:

- Fixed regular payments mean you can easily budget.
- Payments are based only on a proportion of the vehicle's value, keeping your monthly payments lower.
- Our Guaranteed Future Value avoids the risk of unplanned depreciation of your vehicle.
- You defer your ownership decision until the end of the agreement.

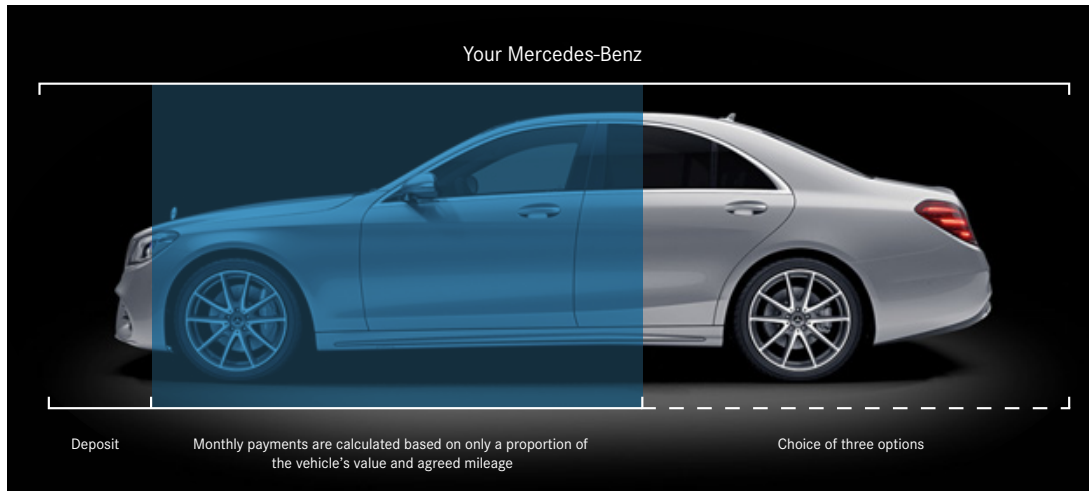

### At the end of your agreement you have three options to choose from.

#### Option 1: Purchase your Mercedes-Benz.

Purchase your Mercedes-Benz by paying the Optional Purchase Payment and Purchase Activation Fee.<sup>1</sup> This will complete the purchase of your Mercedes-Benz, leaving you free to simply enjoy your vehicle.

#### Option 2: Hand back your Mercedes-Benz.

If you decide to return your vehicle to us, it must be in line with our Vehicle Return Standards,<sup>\*</sup> as vehicle condition, excess mileage and other charges may be payable.

#### Option 3: Part-Exchange for a new vehicle.

Purchase your Mercedes-Benz by paying the Optional Purchase Payment and Purchase Activation Fee.<sup>1</sup> This will complete the purchase of your Mercedes-Benz, leaving you free to part-exchange for a new vehicle.

<sup>1</sup>Please note the 'Purchase Activation Fee' of £10 will be debited from your account \*To find out more information about our Vehicle Return Standards please visit <http://mercedes-benz.co.uk/vrs>







Book a [▶ test drive](#)  
[▶ AMG test drive](#)





[▶ Find a Retailer](#)

Follow us on the following social media channels:

 [facebook.com/mercedesbenzuk](https://facebook.com/mercedesbenzuk)

 [twitter.com/mercedesbenzuk](https://twitter.com/mercedesbenzuk)

 [youtube.com/mercedesbenzuk](https://youtube.com/mercedesbenzuk)

 [instagram.com/mercedesbenzuk](https://instagram.com/mercedesbenzuk)

Effective from December 2019 Production. Information correct at time of publication 01.04.2020.

Prices and specifications are subject to change without prior notice.

MBWV222PL/0720 MY800.5

Mercedes-Benz Cars UK Limited, Tongwell, Milton Keynes, MK15 8BA. Company number 2448457 [www.mercedes-benz.co.uk](http://www.mercedes-benz.co.uk)